

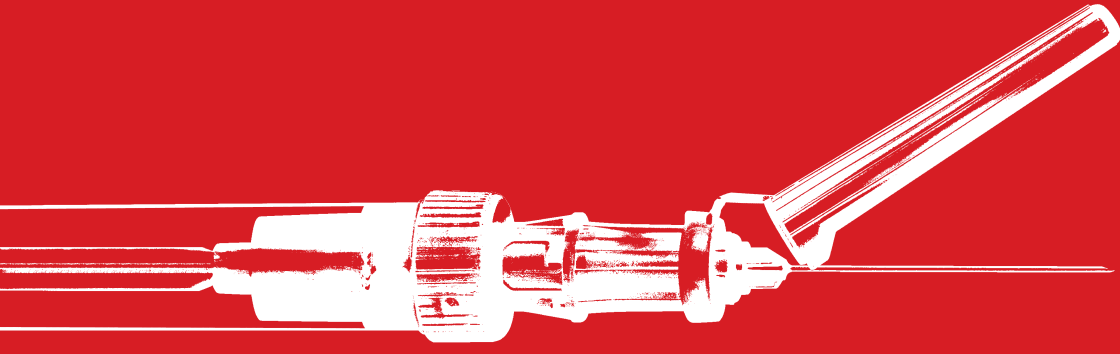

SARSTEDT



Full Product Catalog

2019 / 2020



SARSTEDT International

Your partner in medicine and science worldwide





Venous blood collection and laboratory automation	6–33
Capillary blood, blood sedimentation, and blood gas	34–47
Urine, feces, saliva, CSF, and tissue	48–61
Sample transportation and disposal	62–77
Sample handling	78–117
PCR and molecular biology	118–133
Liquid handling	134–151
Cell and tissue culture	152–171
Microbiology and environmental technology	172–179
General laboratory products	180–185
Hospital supplies	186–205
Transfusion	206–217
Material properties p. 219 · Chemical resistance p. 221 · Key word index pp. 222–225 · Order number index pp. 226–232	



By people, for people – all from a single source

Our organization, the SARSTEDT GROUP, is an international company based in Nümbrecht, Germany. We sell our products through 33 global sales offices and an extensive distributor network.

Virtually all the products in our comprehensive product range are manufactured in cutting edge production facilities in Europe, North America and Australia. The range covers the fields of diagnostics and laboratory automation, life sciences, hospitals and transfusion medicine.

Since our products are used directly on patients and in research and development laboratories, they must conform to a high quality standard, which we meet through our integrated and EN ISO 13485-compliant quality management system.

As a responsibly managed family-owned company with 2,600 employees across the world, our business processes are grounded in value and sustainability. Since its formation in 1961, direct customer contact, innovation and quality have been the foundation for our values and continually developed.

Highly motivated and qualified staff at our sites across the world provide a direct interface between you and the SARSTEDT GROUP. We guarantee reliable SARSTEDT quality with the greatest technical skill and innovative technology. Health and safety of patients and users, together with reproducible research findings, are at the very heart of our business.



EN ISO 13485

DE-M

TRBA 250

CE

ISO 8669

ISO 26825

Biosphere® plus

PCR Performance Tested

P 650

AFNOR



ISO 14820

ISO 23907





S-Monovette® – the revolution in blood collection.

A blood collection system combining two blood collection techniques – the aspiration technique and the vacuum technique – the S-Monovette® is suitable for all veins, regardless of their condition. The system ensures optimal sample quality, thereby producing the best results.

The aspiration technique is a gentle blood collection method for veins in all conditions. It prevents collapse even in the most sensitive of veins, and is ideal for blood collection through an IV catheter.

Where the vein condition is very good, the vacuum technique provides an alternative to aspiration. By creating the vacuum immediately prior to blood collection, a 'fresh' vacuum is always available.

S-Monovette® Safety Needles and Safety Multifly® needles are ready to use directly, without the need for a needle holder. Only ready-to-use systems such as these needles offer safe protection against infection from contaminated, reused needle holders.

To help decision-makers in medical laboratories design safer and more efficient processes, modular automation solutions are available for handling primary and secondary sample tubes. In pre- and post-analytic processes in the clinical laboratory and in microbiology, our systems not only facilitate sample opening and closing but also allow for intelligent sorting, distributing and aliquoting.



Venous blood	
S-Monovette® – the revolution in blood collection	8–9
Product solutions for pediatrics	10–11
S-Monovette® – size options	12–13
S-Monovette® – ordering information	14–15
S-Monovette® – special analytics	16–17
S-Monovette® – needles and adapters	18–19
Accessories for blood collection and other diagnostics	20–21
Secondary tubes, tubes with false bottom, automation tubes and caps	22–26
Block racks	27
Micro Needles	28
Prepared sample tubes	28–29
Laboratory automation	
Centrifuges	30
Single-function solutions	31
Bulk loaders	32
Modular systems	32 - 33

S-Monovette® – the revolution in blood collection

Open system

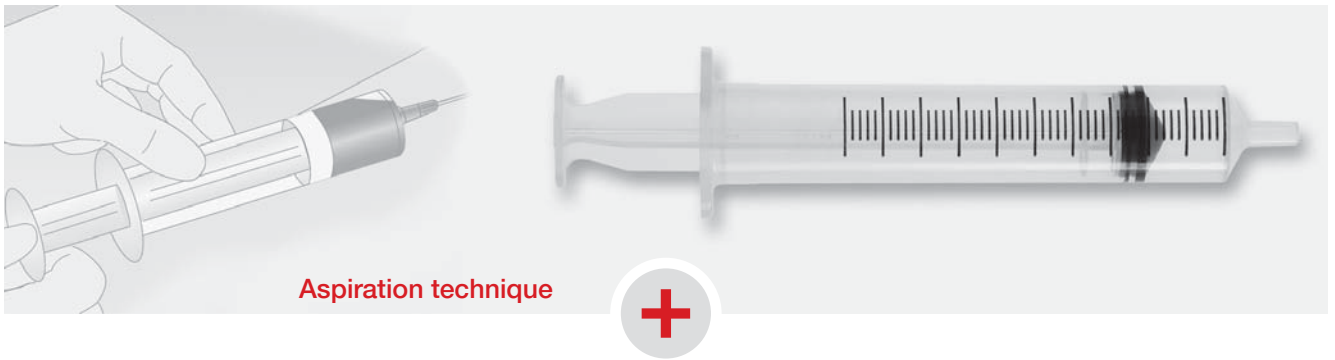

Closed system



One system – two techniques, combined in the S-Monovette®

- ✓ suitable for all veins
- ✓ optimum sample quality
- ✓ cost effective
- ✓ safe

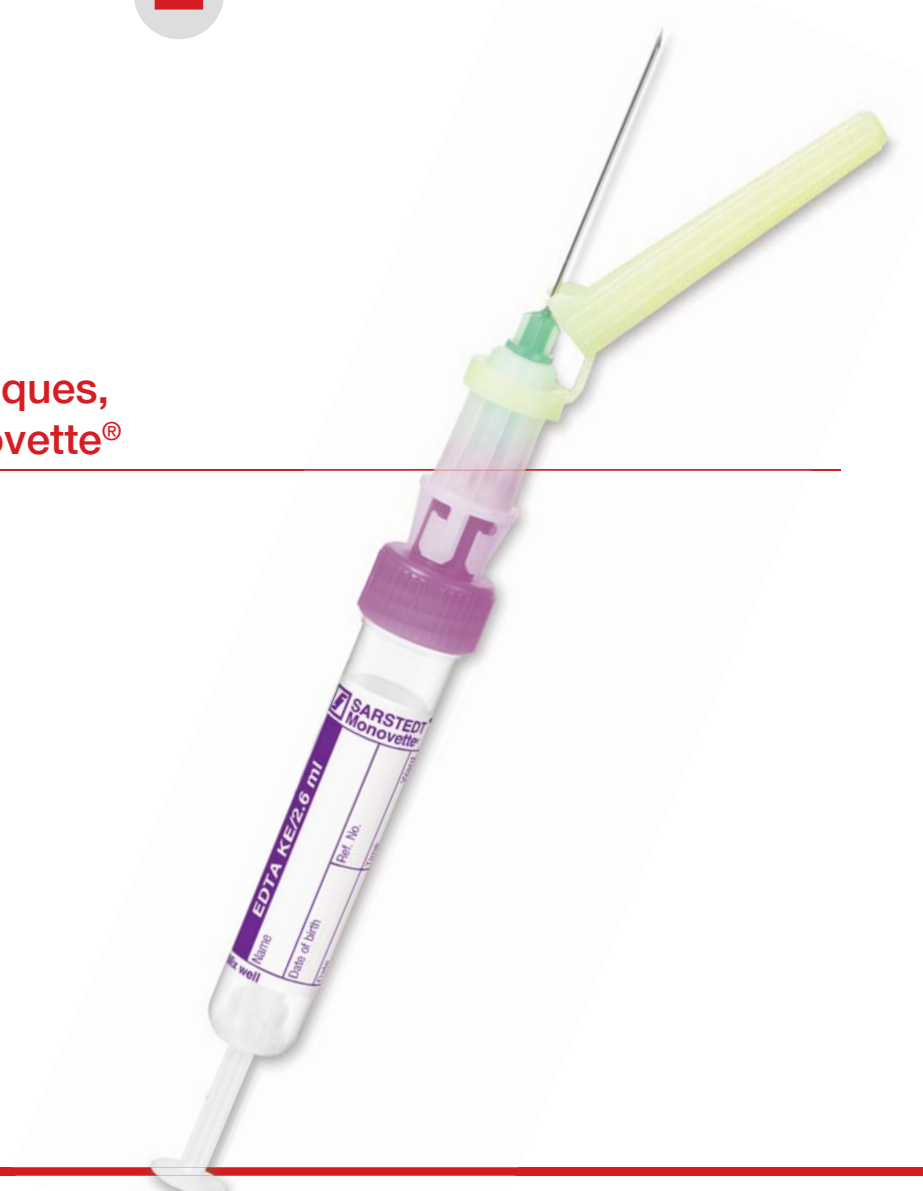

Focus on people

An aging population places particular demands on medical care and blood collection, as difficult vein conditions are increasingly common in older people. Blood collection can also be complicated for children with extremely fragile veins.

The S-Monovette® provides the answer with its variable collection technique in a single system. The user decides on the aspiration or vacuum technique as required.

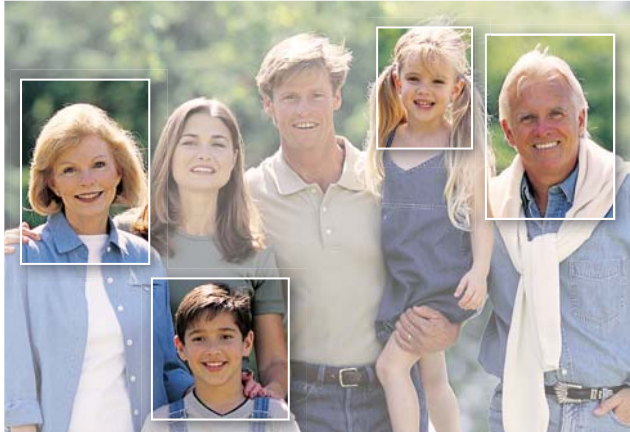

It has been shown that 49.1%* of all patients

- are either under 5 years of age or
- over 65.

* *Deutsche Krankenhausgesellschaft
Figures, data, facts 2011*

A gentle technique is essential for successful blood collection in these significant patient groups.

Aspiration technique

... the gentle technique for routine blood collection

The aspiration technique is the gentle blood collection method for all vein conditions. It prevents collapse in even the most sensitive veins.



Vacuum technique

... a “fresh” vacuum is always available

A particular benefit of the S-Monovette® vacuum technique is the “fresh” vacuum, which is only generated immediately before blood collection. This ensures that an exact fill volume is achieved throughout the shelf life of the product.



Blood collection systems for all ages

In pediatrics, blood collection places high demands on staff and on collection systems. SARSTEDT offers a wide range of different collection systems for venous and capillary blood collection in this field.

- S-Monovette® and Safety-Multifly® needles
- Microvette® and Safety Lancet
- Micro sample tubes and Micro Needles

S-Monovette®, Safety Needles, and Safety-Multifly® needles

The increasing sensitivity of analysis systems makes it possible to reduce the sample volume required, even for comprehensive routine investigations.

With smaller dimensions and low nominal volumes, the S-Monovette® is ideal for pediatrics. Gentle blood collection with the S-Monovette® aspiration technique accommodates difficult vein conditions in pediatrics.



Microvette® and Safety Lancet

Depending on the requirements, the Microvette® is available with a round or conical inner tube and a volume range of 100 to 500 µl.

Both capillary straw and rim collections are available.

The Safety Lancet ensures optimum safety for the patient and user. It is available in various sizes, with a blade or needle.



Micro sample tubes and Micro Needles

The Micro Needle was developed to meet the specific needs of neonatology and has a grooved handle for a safe and secure puncture. The short needles minimize blood loss during sample collection.

Compatible sample tubes are available in a range of forms with screw caps or looped push caps.



The innovative, matched components of the S-Monovette® and needle ensure reliability and safety

- 1 The **Safety Needle** is ready for use and does not require assembly to a needle holder. The precise bevel and superior glide of the Safety Needle in combination with a low puncture angle provide enhanced patient comfort.
- 2 The **deeper recessed membrane** reliably prevents direct user contact for improved infection protection and safe use of the S-Monovette®.
- 3 The **screw cap** enables the tube to be opened gently, minimizing the aerosol effect that occurs when using plug caps.
- 4 The **highly transparent materials** used in the production of the S-Monovette® allow the best possible visual assessment of the sample material.

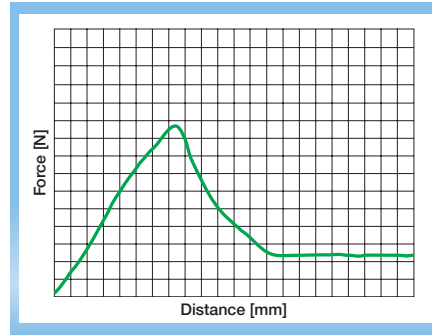

1 Low penetration force due to precise bevel and superior glide



Average outer tube diameter	15 mm	15 mm	13 mm
Outer screw cap diameter	18 mm	18 mm	16 mm
Tube length without cap	92 mm	75 mm	90 mm
Tube length with cap	108 mm	91 mm	106 mm
 Screw cap for reclosing	65.729.300	65.729.300	65.728

The modern blood collection system



2
Recessed membrane for infection protection







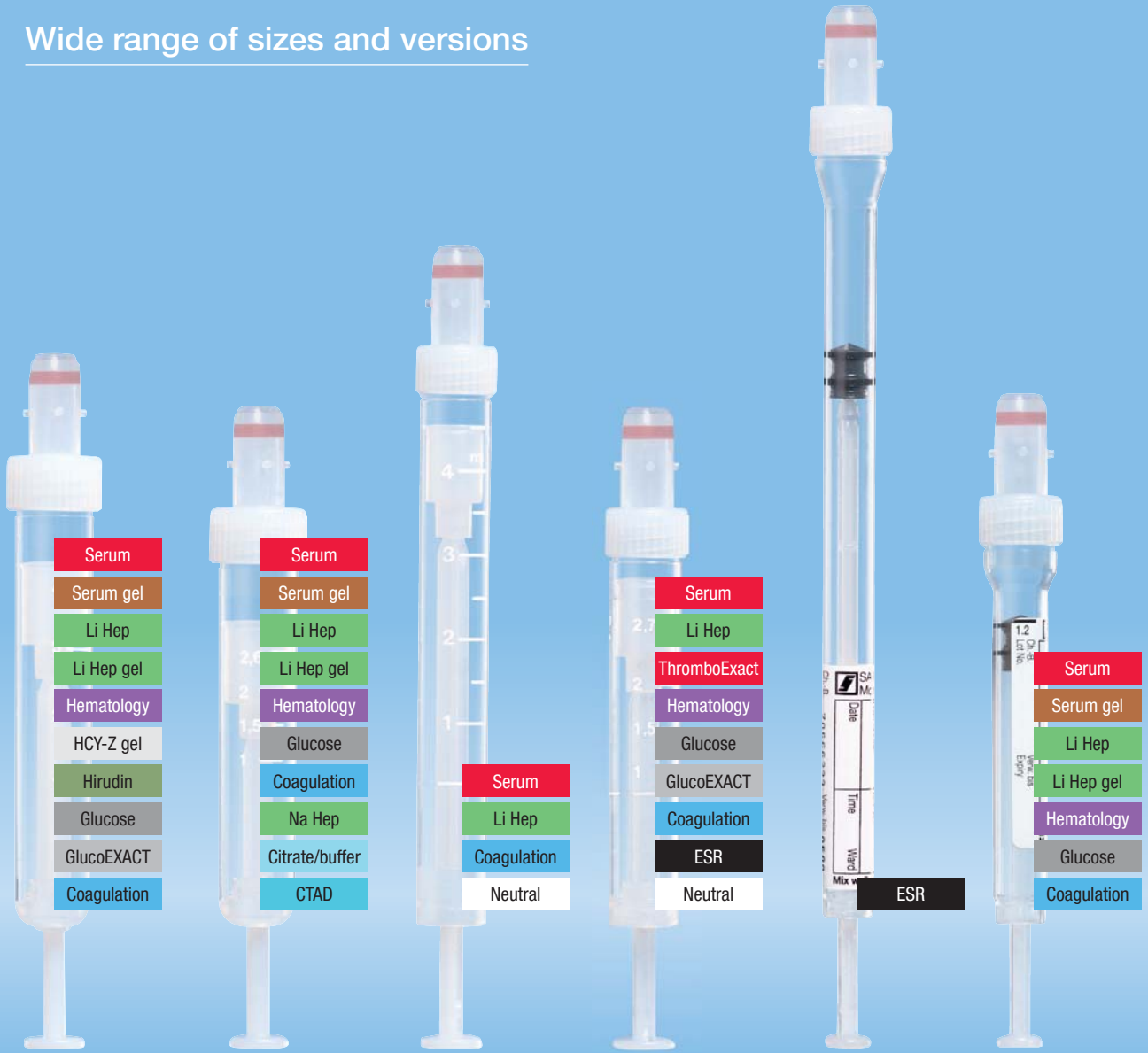





3
Screw cap minimizes the aerosol effect





Wide range of sizes and versions











13 mm	13 mm	11 mm	11 mm	8 mm	8 mm
16 mm	16 mm	13 mm	13 mm	13 mm	13 mm
75 mm	65 mm	92 mm	66 mm	130 mm	66 mm
91 mm	81 mm	108 mm	82 mm	146 mm	82 mm
65.728	65.728	65.1121	65.1121	65.1121	65.1121

Preparation	Volume	Length/Ø	Order No. with colored paper label	Color coded cap/label
 Serum	7.5 ml	92 mm x 15 mm	01.1601.100	
	5.5 ml	75 mm x 15 mm	03.1397.100	
	4.9 ml	90 mm x 13 mm	04.1934.100	
	4.5 ml	92 mm x 11 mm	05.1104.100	
	4.0 ml	75 mm x 13 mm	04.1924.100	
	2.7 ml	75 mm x 13 mm	04.1943.100	
	2.7 ml	66 mm x 11 mm	05.1557.100	
	2.6 ml	65 mm x 13 mm	04.1904.100	
	1.2 ml	66 mm x 8 mm	06.1663.100	

Serum (coagulation activator) The S-Monovettes contain beads coated with a coagulation activator (silicate). Due to the addition of this coagulation-inducing agent, the blood is normally fully coagulated and the sample ready for centrifugation in 20-30 minutes.



Preparation	Volume	Length/Ø	Order No. with colored paper label	Color coded cap/label
 Serum gel	7.5 ml	92 mm x 15 mm	01.1602.001	
	4.9 ml	90 mm x 13 mm	04.1935.001	
	4.7 ml	75 mm x 15 mm	03.1524.001	
	4.0 ml	75 mm x 13 mm	04.1925.001	
	2.7 ml	75 mm x 13 mm	04.1923.001	
	2.6 ml	65 mm x 13 mm	04.1905.001	
	1.1 ml	66 mm x 8 mm	06.1667.001	

Serum gel (coagulation activator) In addition to the coated beads, this S-Monovette® contains a polyacrylester gel. Due to its density, the gel creates a stable separating layer between the blood clot and the serum during centrifugation and serves as a barrier during transportation and storage.

Preparation	Volume	Length/Ø	Order No. with colored paper label	Color coded cap/label
 Lithium heparin (on beads)	7.5 ml	92 mm x 15 mm	01.1604.100	
	5.5 ml	75 mm x 15 mm	03.1628.100	
	4.9 ml	90 mm x 13 mm	04.1936.100	
	4.5 ml	92 mm x 11 mm	05.1106.100	
	0.4 ml	75 mm x 13 mm	04.1920.100	
	2.7 ml	75 mm x 13 mm	04.1929.100	
	2.7 ml	66 mm x 11 mm	05.1553.100	
	2.6 ml	65 mm x 13 mm	04.1906.100	
	1.2 ml	66 mm x 8 mm	06.1666.100	
Lithium heparin liquid	7.5 ml	92 mm x 15 mm	01.1608.100	
	4.9 ml	90 mm x 13 mm	04.1939.100	
 Lithium heparin gel	7.5 ml	92 mm x 15 mm	01.1634.100	
	4.9 ml	90 mm x 13 mm	04.1940.100	
	4.7 ml	75 mm x 15 mm	03.1631.100	
	4.0 ml	75 mm x 13 mm	04.1927.100	
	2.7 ml	75 mm x 13 mm	04.1928.100	
	2.6 ml	65 mm x 13 mm	04.1907.100	
	1.1 ml	66 mm x 8 mm	06.1669.100	

Plasma/plasma gel (lithium heparin, sodium heparin, ammonium heparin) Heparin acts as an anticoagulant for recovering plasma. The heparin is coated onto beads as lithium heparin, sodium heparin or ammonium heparin (generally 16 I.U./ml blood) or is available in a spray dosage in droplet form (generally 19 I.U./ml blood) in the S-Monovette®.

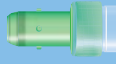
Compatible screw caps can be found on pp. 12–13 and compatible archiving caps on pp. 25 and 90–91.

Preparation	Volume	Length/Ø	Order No. with colored paper label	Color coded cap/label
Sodium heparin 	7.5 ml	92 mm x 15 mm	01.1613.100	
	2.6 ml	65 mm x 13 mm	04.1913.100	

For more information, see p. 14.









Preparation	Volume	Length/Ø	Order No. with colored paper label	Color coded cap/label
EDTA K ₃ 	7.5 ml	92 mm x 15 mm	01.1605.100	
	4.9 ml	90 mm x 13 mm	04.1931.100	
	4.0 ml	75 mm x 15 mm	03.1068.100	
	3.4 ml	65 mm x 13 mm	04.1914.100	
	2.7 ml	75 mm x 13 mm	04.1917.100	
	2.7 ml	66 mm x 11 mm	05.1167.100	
	2.6 ml	65 mm x 13 mm	04.1901.100	
	1.6 ml	66 mm x 11 mm	05.1081.100	
	1.2 ml	66 mm x 8 mm	06.1664.100	
EDTA K ₂ 	2.7 ml	75 mm x 13 mm	04.1915.100	
	2.6 ml	65 mm x 13 mm	04.1900.100	
K ₂ EDTA gel 	7.5 ml	92 mm x 15 mm	01.1621.100	
	4.9 ml	90 mm x 13 mm	04.1932.100	

Hematology K₃ EDTA is available in a spray dosage in droplet form, at a mean concentration of 1.6 mg EDTA/ml blood.

Molecular virus diagnostics In addition to EDTA (1.6 mg/ml blood), S-Monovette® K₂ EDTA gel also contains a gel to ensure a safe barrier layer between blood cells and plasma.

Preparation	Volume	Length/Ø	Order No. with colored paper label	Color coded cap/label
Fluoride 	2.7 ml	75 mm x 13 mm	04.1918.100	
	2.7 ml	66 mm x 11 mm	05.1073.100	
	2.6 ml	65 mm x 13 mm	04.1903.100	
	1.2 ml	66 mm x 8 mm	06.1665.100	

Glucose determination (fluoride) The S-Monovette® for determination of glucose contains fluoride (1.0 mg/ml blood) as a glycolysis inhibitor and EDTA (1.2 mg/ml blood) as an anticoagulant.

Preparation	Volume	Length/Ø	Order No. with colored paper label	Color coded cap/label
Citrate 1:10 	8.2 ml	92 mm x 15 mm	01.1606.100	
	5.0 ml	92 mm x 11 mm	05.1071.100	
	4.3 ml	75 mm x 13 mm	04.1922.100	
	3.0 ml	75 mm x 13 mm	04.1919.100	
	3.0 ml	66 mm x 11 mm	05.1165.100	
	2.9 ml	65 mm x 13 mm	04.1902.100	
	1.8 ml	75 mm x 13 mm	04.1955.100	
	1.4 ml	66 mm x 8 mm	06.1668.100	

Coagulation analysis (sodium citrate) Citrate is supplied as a 0.106 molar solution (corresponding to 3.2% tri-sodium citrate) for use in all coagulation physiological examinations (e.g. Quick, PTT, TZ, fibrinogen). The mixing ratio of 1:10 (1 part citrate to 9 parts blood) must be precisely observed.



Packaging: All of the above S-Monovettes are sterile packed in cardboard boxes of 50 and in shipping cases of 500. S-Monovettes can be individually sterile wrapped as a special order in minimum quantities of 20,000.

S-Monovette® GlucoEXACT	Volume	Length/Ø	Order No. with colored paper label	Color coded cap/label
	3.1 ml	66 mm x 11 mm	05.1074.001	
	3.1 ml	75 mm x 13 mm	04.1945.001	

GlucoEXACT – precise determination of glucose The S-Monovette® GlucoEXACT contains a citrate/fluoride glycolysis inhibitor for the immediate and reliable inhibition of glycolysis. It meets the Gestational Diabetes Guidelines of the German Diabetes Association (DDG) and the German National Disease Management Guidelines (NVL) for type 2 diabetes. The S-Monovette® GlucoEXACT stabilizes the glucose concentration immediately for up to 48 hours at room temperature. A correction factor of 1.16 for calculating the true glucose concentration should be observed.

S-Monovette® Homocysteine HCY-Z gel	Volume	Length/Ø	Order No. with colored paper label	Color coded cap/label
	2.7 ml	75 mm x 13 mm	04.1908.001	

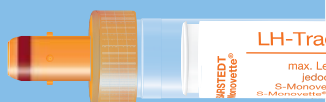



Homocysteine HCY-Z gel – homocysteine determination A specially developed stabilizer maintains the homocysteine concentration relatively constant at room temperature for up to 8 hours after blood collection without centrifugation. If centrifugation is conducted in the first 8 hours and the gel barrier is created between serum and coagulum, stability is maintained for 96 hours.

S-Monovette® metal analysis	Volume	Length/Ø	Order No.	Color coded cap/label
	7.5 ml	92 mm x 15 mm	01.1604.400	
 Safety Needle for metal analysis	Description 21G x 1½", No. 2	38 mm x 0.8 mm	85.1162.600	

Metal analysis – determining trace elements The S-Monovette® metal analysis, used in combination with a special S-Monovette® needle, was developed for testing the most frequently occurring trace elements. As an anticoagulant, lithium heparin (19 I.E./ml blood) is available in a spray dosage in droplet form. For the combined **needle and S-Monovette** system, the following **maximum blank values (in ng/system) apply**:

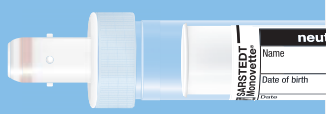
Element	Tl	Cd	Ni	Cr	Pb	Fe	Cu	Zn	Mn	Al	Se	Hg
ng/system	2.5	1.5	8.0	5.0	5	50	70	70	10	40	10	10

The maximum blank values for each element are printed on the S-Monovette® label.



S-Monovette® Neutral	Volume	Length/Ø	Order No. with colored paper label	Color coded cap/label
	7.5 ml	92 mm x 15 mm	01.1728.001	
	4.9 ml	90 mm x 13 mm	04.1926.001	
	4.5 ml	92 mm x 11 mm	05.1727.001	
	2.7 ml	66 mm x 11 mm	05.1729.001	

Without preparation The S-Monovette® Neutral can be used for user-specific investigations. In addition, this S-Monovette® can also be used as a waste tube: if blood collection has been started with an S-Monovette® Citrate (coagulation investigations) in combination with a Safety-Multify® needle, the S-Monovette® Neutral is used as the first (waste) tube for filling the Multify® needle tubing.



Compatible screw caps can be found on pp. 12–13 and compatible archiving caps on pp. 25 and 90–91.

S-Monovette® ThromboExact	Volume	Length/Ø	Order No. with colored paper label	Color coded cap/label
	2.7 ml	66 mm x 11 mm	05.1168.001	

ThromboExact – pseudothrombocytopenia The S-Monovette® ThromboExact helps to exclude false low thrombocyte counts caused by an intolerance to anticoagulants (such as EDTA, citrate and heparin), known as pseudothrombocytopenia. The S-Monovette® ThromboExact, coated with Mg compound, prevents the clumping of thrombocytes and allows the true thrombocyte count to be determined, even up to 12 hours after blood collection.

S-Monovette® CTAD	Volume	Length/Ø	Order No. with colored paper label	Color coded cap/label
	2.9 ml	65 mm x 13 mm	04.1909.100	

CTAD – determining platelet factor 4 The S-Monovette® CTAD inhibits thrombocyte activation for a period of at least 4 hours. As a result, there is a similar delay in the release of proteins such as platelet factor 4 (PF4), β -thromboglobulin (β TG) and plasminogen activator inhibitor (PAI-1). This S-Monovette® is used for monitoring heparin therapies. Routine coagulation analysis is also possible. CTAD consists of sodium citrate as an anticoagulant, with the further addition of theophylline, adenosine and dipyridamole.

S-Monovette® PFA	Volume	Length/Ø	Order No. with colored paper label	Color coded cap/label
	3.8 ml	65 mm x 13 mm	04.1910.001	

PFA/citrate buffer – determining thrombocyte function The S-Monovette® PFA preparation (3.8% citrate buffer, 0.129 mol/l, pH 5.5) was specially developed for the Siemens Healthineers PFA measuring system, to allow precise analysis of thrombocyte function.

S-Monovette® Hirudin	Volume	Length/Ø	Order No. with colored paper label	Color coded cap/label
	1.6 ml	75 mm x 13 mm	04.1959.001	

Hirudin – determining thrombocyte function S-Monovette® Hirudin was developed together with Verum Diagnostica, now known as Roche Diagnostics, for measuring thrombocyte activity using the Multiplate® multiple platelet function analyzer. Unlike citrate or heparin, hirudin works via direct thrombin inhibition and allows thrombocyte function diagnostics in its native state. It is used for monitoring platelet-inhibiting medications during treatment, as well as for detecting or ruling out thrombocyte function disorders.

Packaging: All of the above S-Monovettes are sterile packed in cardboard boxes of 50 and in shipping cases of 500. S-Monovettes can be individually sterile wrapped as a special order in minimum quantities of 20,000.



Safety-Multifly® needle

Order No.	Ø/Length	Description	Color code	Tube length	Packaging
85.1637.235	0.9 mm/19 mm	20G x ¾", No. 1		200 mm	100/box, 400/case, individually wrapped sterile
85.1638.235	0.8 mm/19 mm	21G x ¾", No. 2		200 mm	
85.1640.235	0.6 mm/19 mm	23G x ¾", No. 16		200 mm	
85.1642.235	0.5 mm/19 mm	25G x ¾", No. 18		200 mm	
85.1637.205	0.9 mm/19 mm	20G x ¾", No. 1		80 mm	100/box, 400/case, individually wrapped sterile
85.1638.205	0.8 mm/19 mm	21G x ¾", No. 2		80 mm	
85.1640.205	0.6 mm/19 mm	23G x ¾", No. 16		80 mm	
85.1642.205	0.5 mm/19 mm	25G x ¾", No. 18		80 mm	
85.1638.201	0.8 mm/19 mm	21G x ¾", without multi-adapter		240 mm	100/box, 400/case, individually wrapped sterile
85.1638.200	0.8 mm/19 mm	21G x ¾", detachable guide sleeve		200 mm	



S-Monovette® Safety Needle

Order No.	Ø/Length	Description	Color code	Packaging
85.1372.200	0.9 mm/25 mm	20G x 1"		50/box • 500/case, individually wrapped sterile
85.1373.200	0.8 mm/25 mm	21G x 1"		50/box • 500/case, individually wrapped sterile
85.1441.200	0.7 mm/25 mm	22G x 1"		50/box • 500/case, individually wrapped sterile
85.1160.200	0.9 mm/38 mm	20G x 1½"		50/box • 500/case, individually wrapped sterile
85.1162.200	0.8 mm/38 mm	21G x 1½"		50/box • 500/case, individually wrapped sterile
85.1440.200	0.7 mm/38 mm	22G x 1½"		50/box • 500/case, individually wrapped sterile



Multi-adapter

- The multi-adapter is available in Luer and Luer lock versions. It allows an S-Monovette® to be connected to all Luer systems, including indwelling venous needles, three-way valves and butterfly needles.

Order No.	Description	Fig.	Packaging
14.1205.100	Multi-adapter with Luer lock	A	100/box • 1000/case, individually wrapped sterile
14.1205	Multi-adapter	B	100/box • 1000/case, individually wrapped sterile

Membrane adapter

- The membrane adapter allows the S-Monovette® needle and Safety-Multify® needle to be securely connected to a Luer system such as the Blood Gas Monovette®.

Order No.	Description	Fig.	Packaging
14.1112	Membrane adapter	C	100/box • 1000/case, individually wrapped sterile



Universal blood culture adapter

- The Universal blood culture adapter was specially developed for use with the Safety-Multify® needle. The shape of the Universal blood culture adapter enables standard blood culture bottles with wide and narrow necks to be filled. Blood can then be collected with the S-Monovette®.

Order No.	Description	Packaging
14.1209	Universal blood culture adapter	20/box • 100/case, individually wrapped sterile



LongNeck blood culture adapter

- The LongNeck blood culture adapter is compatible with blood culture bottles with narrow necks.

Order No.	Description	Packaging
14.1207	LongNeck blood culture adapter	50/box • 250/case, individually wrapped sterile



Universal blood culture adapter with Safety-Multify® needle

Order No.	Ø/Length	Description	Color code	Tube length	Packaging
51.1638.945	0.8 mm/19 mm	21G x ¾", No. 2		200 mm	50/pack, individually wrapped sterile
51.1640.945	0.6 mm/19 mm	23G x ¾", No. 16		200 mm	



Safety-Multify® needle with fitted holder

Order No.	Ø/Length	Description	Color code	Tube length	Packaging
85.1638.935	0.8 mm/19 mm	21G x ¾", No. 2		200 mm	25/box • 100/case, individually wrapped sterile

Accessories for blood collection



Tourniquet

Order No.	Description	Packaging units/case
95.1007.101	Disposable tourniquet · latex-free · 1" wide	250/bag 1,000/case



Disposable tourniquets

Prevents the development of nosocomial infections through venous punctures

- Maximum hygiene standards and high levels of patient comfort
- Minimizes the risk of cross-infection

Order No.	Description	Packaging units/case
95.1006	Disposable tourniquets	200/dispenser box, 4,800/case
95.1005	Wall holder for disposable tourniquets	1



Color-coded caps for S-Monovette®

- Color-coding of emergency samples from ambulances, intensive care units, and operating theaters, or to optimize organization of the laboratory
- Rapid allocation of emergency samples at the laboratory reception area
- Tubes with color-coded caps assembled can be used directly in many analysis systems

Order No.	Color	Packaging
14.1513	Hot pink	100/bag • 1,000/case
14.1513.001	Blue	100/bag • 1,000/case
14.1513.002	Yellow	100/bag • 1,000/case
14.1513.005	Green	100/bag • 1,000/case
14.1513.008	Gray	100/bag • 1,000/case



Seraplas® V for S-Monovette®

Valve separator for separating serum/plasma and cellular constituents following centrifugation

After separation, the plunger is easily removed, leaving the valve in place as a barrier to prevent diffusion between the cell layer and supernatant during transport, analysis, and storage. The dimensions of the primary receptacle remain unchanged after separation. Tubes containing valve separators are suitable for direct analysis.

Order No.	Description	Suitable for S-Monovette® Ø	Packaging units/case
53.677*	Seraplas® V11	11 mm	5,000
53.419	Seraplas® V13	13 mm	1,000
53.428	Seraplas® V15	15 mm	1,000
53.420	Seraplas® V16	16 mm	1,000

Should subsequent centrifugation be required, the valve of the separator can be removed using another plunger (No. 53.1030).

Order No.	Description	Suitable for	Packaging units/case
53.1030	Plunger for valve removal	Valve separator V13, V15, V16	2,000

* The Seraplas® V11 is supplied with a separate unattached plunger.

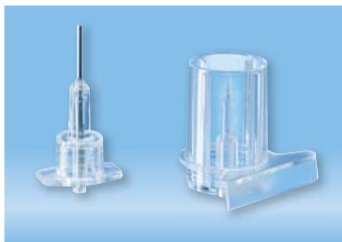

Haemo-Diff® – for manual blood smears using the S-Monovette®

Order No.	Description	Packaging
14.1218	With smear edge	500/bag 2,000/case
14.1217	Without smear edge	500/bag 2,000/case

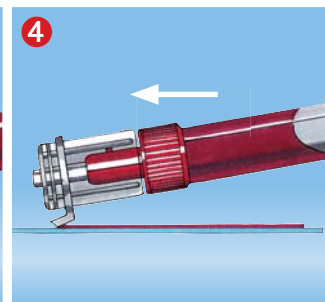
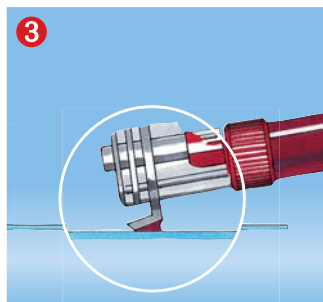
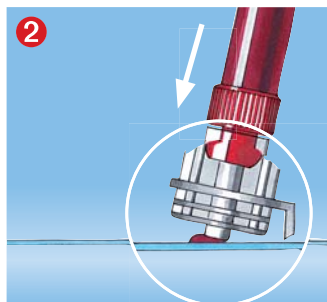
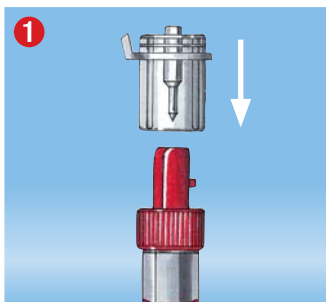

Carrier tubes for S-Monovette® Pediatric 1.1–1.4 ml

- For proper tube fit in racks and centrifuges
- Can be barcode labeled

Order No.	Description	Packaging
55.1570	Flat-base carrier tube for S-Monovette® with 8 mm Ø for adaptation to external dimensions of 66 x 11 mm	250/bag 1,000/case
55.1570.002	Same as 55.1570 but amber for light protection	250/bag 1,000/case
55.1572	Round-base carrier tube for S-Monovette® with 8 mm Ø for adaptation to external dimensions of 65 x 13 mm	250/bag 1,000/case
55.1571	Round-base carrier tube for S-Monovette® with 8 mm Ø for adaptation to external dimensions of 75 x 13 mm	250/bag 1,000/case
55.1571.051	Same as 55.1571 but pale blue	250/bag 1,000/case



Carrier tubes for Microvette® and micro sample tubes

Order No.	Description	Packaging
55.525.005	Closed, round-base carrier tube for Microvette®, micro sample containers, Ø 13 mm, length 75 mm	1,000/bag 2,000/case
55.525.302	Same as 55.525.005 but amber for light protection	250/bag 2,000/case
55.1571	Open, round-base carrier tube for Microvette®, micro sample containers, Ø 13 mm, length 64 mm	250/bag 1,000/case
55.1571.051	Same as 55.1571 but pale blue	250/bag 1,000/case
55.1577	Flat-base carrier tube for Multivette® Ø 11.5 mm, length 60 mm	250/bag 1,000/case
55.1577.002	Same as 55.1577 but amber for light protection	250/bag 1,000/case

Sample cups for analysis systems



Sample cup for Hitachi analyzers

Order No.	Material	Volume in ml	Length/Ø in mm	Tube type	Packaging units/case	Compatible cap
73.666	PS	2.0	38/17	A	5,000	65.718

Sample cup for Abbott AXSYM analyzers

Order No.	Material	Volume in ml	Length/Ø in mm	Tube type	Packaging units/case	Compatible cap
73.667	PS	2.5	53/12	B	2,500	---

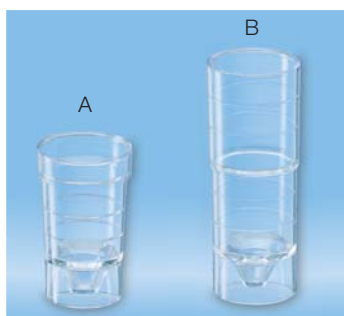

Sample cups for auto-analyzers

Order No.	Material	Volume in ml	Length/Ø in mm	Tube type	Packaging units/case	Compatible caps
73.641	PS	1.5	24/14	A	5,000	65.649
73.646	PS	3.5	38/14	B	5,000	65.649



Cap for sample cups

Order No.	Material	Description	Color	Packaging units/case
65.649	LD-PE	Closed lid	Neutral	10,000

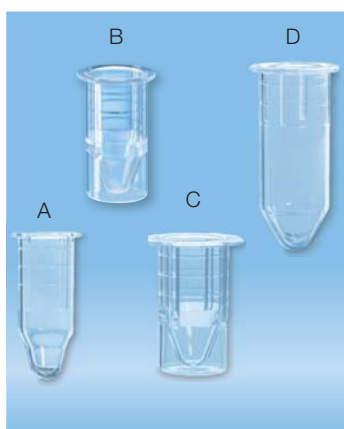

Inserts

For low serum/plasma yields, these hanging cups can be used in combination with S-Monovettes or tubes to elevate the sample for analysis.

Order No.	Material	Length in mm	Suitable for S-Monovette® of Ø	Tube type	Packaging
73.1051	PS	23.5	13 mm	A	500/bag 2,000/case
73.1052	PS	23.5	15 mm	B	500/bag 2,000/case
73.1053	PS	23.5	16 mm	C	500/bag 2,000/case
73.1052.001	PS	32.0	15 mm	D	500/bag 2,000/case



Sample cup for Coulter Counter, lids included

Order No.	Material	Length/Ø in mm	Color	Packaging units/case
73.650.500	PS	60/34	Neutral	500

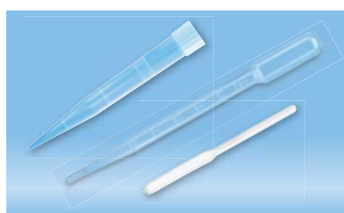

Accessories

Transfer pipettes and pipette tips for creating aliquots can be found on pp. 141 and 148-149, stirring rods on p. 184.

PS = transparent polystyrene, LD-PE = low density polyethylene



Conical tube for Pharmacia/LKB gamma counter

- With narrow tip for optimum sediment recovery
- Transparent polypropylene
- Suitable for all rack and instrument types, old and new

Compatible with the following Pharmacia/LKB devices:

1270 – Rackgamma	(Rack type 1270-132)	1277 – Gammamaster	(Rack type 1277-150)
1271 – Riagamma	(Rack type 1270-132)	1260 – Multigamma	(no racks)
1272 – Clinigamma	(Rack type 1270-142)	1261 – Multigamma	(no racks)
1275 – Minigamma	(Rack type 1270-132)	1282 – Compugamma	(Rack type 1282-131)

Order No.	Material	Volume in ml	Length/Ø in mm	Packaging units/case	Compatible caps
57.477.500	PP	4.5	75/12	4,000	65.809.300 65.719



Sample tubes for Cobas systems Bio, Mira, Fara and Integra

Order No.	Material	Volume in ml	Length/Ø in mm	Color	Packaging units/case	Cap
73.910	PP	0.6	34/8.2	Blue	5,000	Attached
73.910.001	PP	0.6	34/8.2	Red	5,000	Attached
73.910.002	PP	0.6	34/8.2	Green	5,000	Attached
73.910.003	PP	0.6	34/8.2	Yellow	5,000	Attached
73.910.004	PP	0.6	34/8.2	White	5,000	Attached



Cuvette and steel balls for Amelung KC coagulometer (macro)

Order No.	Description	Packaging units/case
73.834	2 bags of 1,000 cuvettes and 2 dispenser bottles with 1,000 steel balls each	2,000

PP = polypropylene

* For illustrations of caps see pp. 90–91



RIA vial, 0.5 ml

- Efficient centrifuging in standard centrifuges with microtest plate inserts
- Firm adherence of sediment during second antibody separation
- Suitable for other separation procedures such as magnetic separation of iron oxide-coupled antibodies
- Shape compatible with almost all existing gamma counters
- Minimizes waste volume – economical disposal

Order No.	Description	Packaging units/case
73.1055	RIA vial, highly transparent polypropylene	10,000
65.1375	Push cap for 73.1055, also suitable for Roche Microcups	10,000



Disposable tube for Immunoassay Analyzer ES 600 and ES 300, crystal-clear PS, for patient serum

Order No.	Volume in ml	Length/Ø in mm	Packaging units/case
73.663	2.0	40/12	5,000

Order No.	Description	Packaging
65.108	Push cap for 73.663	10,000



Mini-vial with screw cap, HD-PE

Order No.	Description	Length/Ø in mm	Packaging units/case
73.680	6ml vial with screw cap	56/15	2,000



20 ml HD-PE scintillation vial

Order No.	Description	Length/Ø in mm	Packaging units/case
73.662.500	Supplied with screw cap	58/27	500

HD-PE = high density polyethylene, PS = Transparent polystyrene



PP tubes with conical false bottom, HD-PE screw caps

- Conical false bottom suitable for elevating small volumes for direct analysis
- Meets IATA requirements for sample shipping
- 75 x 13 mm
 - Rounded base
 - Suitable for deep-freezing
 - Can be centrifuged up to 4,500 x g, 10 mins.
 - User-friendly, compact StackPack packaging
- 92 x 13 mm
 - Rounded or flat base
 - Can be centrifuged up to 3,000 x g, 10 mins.
- 92 x 15 mm
 - Rounded or flat base
 - Can be centrifuged up to 3,000 x g, 10 mins.







PP tubes 75 x Ø 13 mm with conical false bottom

Order No.	Length/Ø	Volume	Description	Tube base	Packaging
60.614.010	75/13 mm	2.5 ml	Without cap	Round	2,000 pcs./case
60.614.015	75/13 mm	2.5 ml	Without cap	Round	500 StackPack 2,000 pcs./case
60.614.011	75/13 mm	2.5 ml	Cap assembled	Round	2,000 pcs./case
65.647	65.647.020	65.806.300	65.1379	65.163	
Archiving cap	Archiving cap with filter	Push cap	Universal caps	Screw cap	
					
5,000 pcs./case	5,000 pcs./case	10,000 pcs./case	10,000 pcs./case	5,000 pcs./case	



PP tubes 92 x Ø 13 mm with conical false bottom

Order No.	Length/Ø	Volume	Description	Tube base	Packaging
60.617.010	92/13 mm	3.5 ml	Without cap, without print	Round	1,000 pcs./case
62.617	92/13 mm	3.5 ml	Cap assembled, with print	Round	
60.613.010	92/13 mm	3.5 ml	Without cap, without print	Flat	
62.613	92/13 mm	3.5 ml	Cap assembled, with print	Flat	
65.647	65.647.020	65.806.300	65.1379	65.728	
Archiving cap	Archiving cap with filter	Push cap	Universal caps	Screw cap	
					
5,000 pcs./case	5,000 pcs./case	10,000 pcs./case	10,000 pcs./case	5,000 pcs./case	

HD-PE = high density polyethylene, PP = polypropylene

Tubes with/without false bottom • Universal caps



PP tubes 92 x Ø 15.3 mm with conical false bottom

Order No.	Length/Ø	Volume	Description	Tube base	Packaging
60.612.310	92/15.3 mm	5.0 ml	Without cap, without print	Round	1,000 pcs./case
62.612.300	92/15.3 mm	5.0 ml	Cap assembled, with print	Round	
60.611.311	92/15.3 mm	5.0 ml	Amber, without cap, without print	Flat	
60.611.310	92/15.3 mm	5.0 ml	Without cap, without print	Flat	
62.611.300	92/15.3 mm	5.0 ml	Cap assembled, with print	Flat	

65.647	65.647.020	65.803.300	65.1379	65.645*	65.729.300
Archiving cap	Archiving cap with filter	Push cap	Universal caps	Screw cap	Screw cap

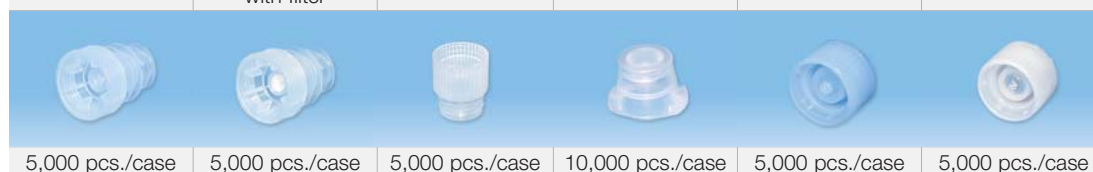

5,000 pcs./case	5,000 pcs./case	5,000 pcs./case	10,000 pcs./case	5,000 pcs./case	5,000 pcs./case
-----------------	-----------------	-----------------	------------------	-----------------	-----------------

* Recommended for SARSTEDT RC 1200



PP secondary tubes with round base

Order No.	Length/Ø	Volume	Description	Matching cap	Packaging units/case
60.504.021	75/13 mm	5.0 ml	Without caps, 1,000 pcs./bag	65.163.303	2,000
60.504.022	75/13 mm	5.0 ml	Without caps, 500 pcs./StackPack	65.163.303	2,000
60.503.010	90/13 mm	6.5 ml	Without caps, 500 pcs./bag	65.728	2,000
60.610	92/15.3 mm	10.0 ml	Cap included, 500 pcs./bag	65.729.300	1,000

For more secondary tubes with round base, see p. 81-84.

Anti-evaporation cap for S-Monovette®

- Suitable for S-Monovettes Ø 15 mm

Order No.	Color	Packaging units/case
65.648	Neutral	5,000

Universal caps

- Double-sided caps are suitable for S-Monovette® Ø 13 mm and for tubes of Ø 12 to 17 mm

Order No.	Color	Packaging units/case
65.1379	Neutral	10,000
65.1379.002	Red	10,000
65.1379.004	Yellow	10,000
65.1379.005	Green	10,000
65.1379.006	Blue	10,000
65.1379.007	Violet	10,000
65.1379.008	Gray	10,000

PP = polypropylene

Single block rack for 50 tubes

- Can be autoclaved at 121°C
- Custom printing on front side is possible (minimum order 250)

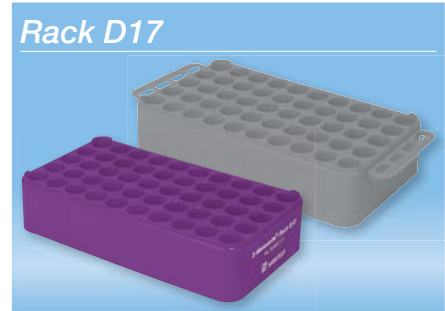
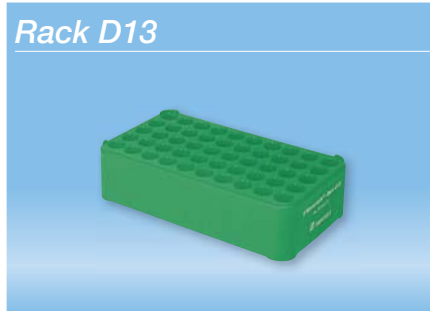

Rack D12

Suitable for S-Monovette® up to diameter 11 mm and tubes up to 12 mm in diameter.

Dimensions: (length x width x height)
152 x 80 x 45 mm

Order No.	Color	Packaging units/case
93.854	Gray 	20
93.854.121	Red 	20
93.854.122	Yellow 	20
93.854.123	Green 	20
93.854.124	Blue 	20
93.854.125	Orange 	20

Rack D13

Suitable for S-Monovette® and tubes of Ø 8 mm to Ø 13 mm.

Dimensions: (length x width x height)
180 x 96 x 45 mm

Order No.	Color	Packaging units/case
93.853	Gray 	16
93.853.131	Red 	16
93.853.132	Yellow 	16
93.853.133	Green 	16
93.853.134	Blue 	16
93.853.135	Orange 	16

Rack D17 with and without handles

Suitable for S-Monovette® up to diameter 16 mm and tubes up to 17 mm in diameter.

Dimensions: (length x width x height) Without handle: 209 x 109 x 45 mm – With handle: 246 x 109 x 45 mm

Order No.	Color	Handles	Packaging units/case
93.852	Gray 	Without	20
93.851		With	12
93.852.171	Red 	Without	20
93.851.171		With	12
93.852.172	Yellow 	Without	20
93.851.172		With	12
93.852.173	Green 	Without	20
93.851.173		With	12

Order No.	Color	Handles	Packaging units/case
93.852.174	Blue 	Without	20
93.851.174		With	12
93.852.175	Orange 	Without	20
93.851.175		With	12
93.852.168	Brown 	Without	20
93.852.169	Violet 	Without	20
93.852.170	White 	Without	20

For 100-tube double block racks and other racks, see p. 116



Protective cover for block rack, autoclavable

- Compatible with block rack D 17

Order No.	Color	Packaging units/case
93.857	Light gray 	25

Micro Needles · Prepared micro sample tubes



Micro Needles

- Minimal blood loss from sample hold up
- Ribbed grip for needle control
- Can be rotated 360° for difficult veins
- Optimal flow thanks to exceptional needle quality and exposed outlet

Order No.	Description	Color	Packaging
85.921	Micro Needle 21G x 3/4"		50/box • 500/case
85.923	Micro Needle 23G x 3/4"		50/box • 500/case
85.925	Micro Needle 25G x 3/4"		50/box • 500/case

Micro sample tubes with attached LD-PE push caps

- 1.3 ml nominal volume
- Conical inner base
- Transparent label

Packaging: 1,000/case
 Tube dimensions: L 40 mm
 Ø 10.8 mm



Serum coagulation activator		Serum gel coagulation activator		Plasma lithium heparin	Hematology potassium EDTA	Glucose fluoride	Citrate coagulation	
41.1501.105	41.1500.005	1.1 ml	41.1503.105	41.1504.105	41.1505.105	41.1506.105	1.3 ml	
						41.1506.100	1.0 ml	
						41.1506.102	0.5 ml	

Micro sample tubes with screw cap

- Screw cap with sealing O-ring
- 1.3 ml nominal volume
- Conical inner base
- Paper label

Packaging: 1,000/case
 Tube dimensions: L 45 mm
 Ø 10.8 mm











Serum coagulation activator		Serum gel coagulation activator		Plasma lithium heparin	Hematology potassium EDTA	Glucose fluoride	Citrate coagulation
41.1392.105	41.1378.005	1.1 ml	41.1393.105	41.1395.105	41.1395.105	41.1394.105	41.1350.105
					with membrane screw cap		

LD-PE = low density polyethylene

For corresponding racks for screw cap micro sample tubes, see pp. 112-115.



PP sample tubes with round bases, with push caps and printed label

Volume ml	Order Number Description	Preparation	Length/Ø mm	Packaging pcs./case
10	26.367.100	 Serum clotting activator	95.0 x 16.8	1,000
	26.369.100	 Plasma Lithium-Heparin		
	26.358.100	 Hematology Potassium EDTA		
5	32.329.100 4.5 ml	 Serum clotting activator	75.0 x 13.0	1,000
	32.332.100	 Hematology Potassium EDTA		
	32.333.100 2.0 ml	 Glucose Fluoride		
4	36.336.100	 Plasma Lithium-Heparin	75.0 x 12.0	2,000
	36.338.100	 Hematology Potassium EDTA		
2	38.346.100	 Hematology Potassium EDTA	55.0 x 12.0	2,000



Pre-dosed sample tubes for direct adaptation to special analyzers

Order No.	Preparation	Dosage quantity/capillary	Length/Ø in mm	Description	Packaging units/case
45.498.003	Hemolysis solution for determining glucose (SARSTEDT)	1,000 µl/20 µl	92/15.3 (round base)	Tube with conical false bottom	500
47.409.001	Tinaquant® hemolysis solution for determining HbA _{1c} (Roche)	1,000 µl/10 µl	66/11.5	Tube for Cobas Integra 800 (Roche) with cap piercing	500

PP = polypropylene

Centrifuges

Centrifugation of serum/plasma samples in combination with separator gels or valve filters as a diffusion barrier immediately after blood collection, i.e. at the doctor's office or at phlebotomy stations, ensures sample stability and accurate results. Centrifugation is ideally conducted in a swing-out rotor rather than in a fixed-angle rotor.

Centrifugation with swing-out rotor

- Thick and stable separating layer

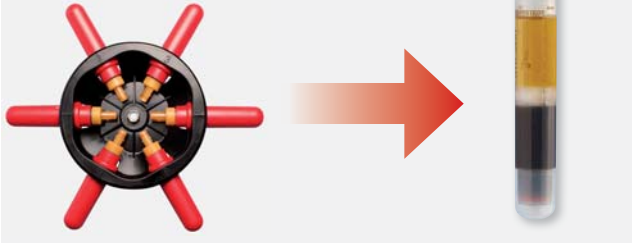

Centrifugation with fixed-angle rotor

- Thin and unstable separating layer



Centrifuge SMC 6 (blood) and SMC 6plus (blood and urine)

The compact SMC 6 centrifuge operates at a defined rotational speed at the push of a button and is therefore ideal for doctor's offices and small labs. The swing-out rotor accommodates 6 blood or test tubes up to 17 x 100 mm. The electronic timer can be adjusted from 1 to 30 minutes.

Order No.	Description
90.184.561	Centrifuge SMC 6, 115-230 V with 6-position swing-out rotor, 6 tube holders up to 100 mm, 6 tube holders up to 75 mm
90.184.661	Centrifuge SMC 6plus, 115-230 V, additional centrifugation program with low acceleration for urine analysis
92.184.551	Tube holder, up to 100 mm, 1 pc.
92.184.552	Tube holder, up to 75 mm, 1 pc.
92.184.553	Rubber adapter, 25.4 mm, 6 pcs.
92.184.554	Rubber adapter, 6.4 mm, 6 pcs.
92.184.555	Cap for tube holder, 1 pc.



Centrifuge LC 24

All of the important functional parameters can be selected, from variable acceleration and braking to simple presetting of duration and speed. The LC 24 stores up to 10 user programs.

The tube holders and the swing-out rotor included in the standard delivery are easy to load and will hold up to 24 tubes per cycle.

Order No.	Description
90.184.701	Centrifuge LC 24, 115 V, with 6-position swing-out rotor, 6x 4-position tube holders up to 100 mm, 6x caps for 4-position tube holders
92.184.751	Tube holder LC 24/LC 24 E, 4-position, up to 100 mm, 6 pcs.
92.184.752	Tube holder LC 24/LC 24 E, 1-position, for 50 ml tubes, 6 pcs.
92.184.755	Cap for tube holder LC 24/LC 24 E, 6 pcs.

Decapping – Recapping

Specimen tubes are routinely opened and closed in the lab during sample preparation for analysis, archiving, or shipping. With regularly high throughputs, these activities are a frequent source of injury (RSI) and pose an infection risk if performed manually. Our decades of experience in blood collection and sample preparation fueled the development of our practical, simple, and robust automatic decappers and recappers. These devices are offered for benchtop use or are available with a floor cabinet that has storage space for the compressed air supply or cap disposal.

Tubes are loaded in and out for processing in linear analysis racks (e.g. Roche-Hitachi, Beckman-AU, Siemens-Centaur, Abbott-Architect, Tecan, Hamilton and many others). Depending on the device configuration, mixed size tubes of 65–100 mm in length and 11–16 mm in diameter can be processed. Universal stopper caps or screw caps are available from SARSTEDT for closure.



Decapper DC 1200

- Prevents RSI and minimizes infection risk
- For tubes 11–16 mm in Ø, 65–100 mm in length
- Mixed processing without need to pre-sort by tube size
- Decapping is carried out in the analysis rack – no reloading required
- Available for many linear analysis racks
- Loading and unloading from tray
- High throughput of up to 1,200 tubes/hour



Recapper RC 1200

- Prevents RSI and minimizes infection risk
- Uses universal archiving caps
- For all tubes 13–16 mm in Ø, 65–100 mm in length
- Prevents evaporation and sample contamination
- Mixed processing without the need to pre-sort by tube size
- Available for many linear analysis racks
- Loading and unloading from tray
- High throughput of up to 1,200 tubes/hour
- Automatic opening possible on all decappers



Recapper RC 1200 S

- Prevents RSI and minimizes infection risk
- Uses SARSTEDT screw caps, 13 or 15 mm Ø
- For 13 or 15 mm Ø SARSTEDT tubes
- Prevents evaporation and sample contamination
- Available for many linear analysis racks
- Loading and unloading from tray
- High throughput of up to 1,200 tubes/hour
- Ideal for long-term storage or sample transport
- Automatic opening possible on all decappers

Identification and Accessioning – Decapping – Sorting – Aliquoting – Labeling – Recapping

Bulk loading systems for sample accessioning and sorting into racks or bins

- Ideal in combination with any analytical platform
- No pre-sorting or handling of sample tubes required
- Processes any tube type of 75 to 120 mm in length (with cap) and 11 to 19 mm in Ø, including those with false bottom
- For all sample types (serum/plasma, serum gel/plasma gel, EDTA, citrate, blood sugar, urine)
- Integral ID module with tube recognition
- Automated sample accessioning
- Customized sorting into a variety of carrier types or bins
- Safe, rapid, and continuous operation

BL 1200 ID – sorting into racks (bulk-to-rack)

- Throughput of up to 1,200 tubes per hour
- Up to 600 tubes per sorting platform/channel
- Up to 1,200 tubes with two platforms
- Sorts into all common racks and trays

HCTS 2000 MK2 – sorting into bins (bulk-to-bulk)

- Throughput of up to 2,000 tubes/hour
- 7 target compartments; optional modules extend to 12, 17 or 22
- Optional camera for tube recognition

The innovative bulk loader revolutionizes sample processing in the clinical laboratory. Closed sample tubes (e.g. S-Monovette®) are loaded in bulk into the bulk loader bin – no need to handle each individual tube.

Tubes are automatically separated, and the sample type and ID number (barcode) are then identified via the integral ID module.

Samples can be distributed and sorted into centrifuge adapters, feeder/exit trays for laboratory lines, analyzer racks, standard racks, BL 1200 ID archive carriers or MK2 bins, according to customer specification. Tubes are distributed either according to defined parameters or to sample-related information received from the LIS (laboratory information system). Plausibility checks detect and separate out error samples.



BL 1200 ID



HCTS 2000 MK2

Sorter DC/RC 900 Flex · The compact solution for pre- and post-analytics

- Pre- and post-analytics in one device
- High throughput of up to 900 tubes/hour
- Processes any tube diameter from 11 to 19 mm
- Compatible with most racks or carrier types
- Online or offline operation
- Opens tubes with push caps and screw caps
- Identifies tubes with a bar code reader and color sensor
- Can sort by tube type, barcode, material (cap color), etc.
- Closes tubes with archiving caps
- Closes 13 or 15 mm Ø SARSTEDT tubes with screw caps, e.g. the S-Monovette®
- Can be retrofitted with decapping or recapping modules

DC/RC 900 Flex combines pre- and post-analytics in one compact standalone system ensuring optimum capacity utilization along with superior efficiency. Repetitive manual work such as laboriously opening and closing sample tubes is eliminated, thereby protecting human resources.

All tubes of 65 to 100 mm in length and 11 to 19 mm in diameter can be processed in a mixed operation without presorting. Other tube sizes can be accommodated upon request. Both push caps and screw caps are safely removed and hygienically discarded.

The customized platform can be configured for most racks and carrier systems, both for analyzers and for archiving systems. The control software can be programmed with any tube processing criteria and is designed for online and offline operation. Tubes of any

diameter are closed with an archiving cap. The system can also initially be set up as a decapper or recapper only, and subsequently retrofitted.



Identification and Accessioning – Decapping – Sorting – Aliquoting – Labeling – Recapping

Pre- and post-analytics in one modular system

- Full function pre- and post-analytical system
- Ideal in combination with any analytical platform
- Modular configuration according to customer needs with:
 - Loading platform and/or
 - Bulk loader
 - ID Module
 - Decapper
 - Recapper
 - Aliquoter
 - Sorter
- For all common tube types
 - 11–16 mm Ø
 - 65–100 mm length
- Compatible with most racks and carrier systems

The PVS 1625 is an automation system configured to customer requirements **for pre- and post-analytical processing of samples**. It is not restricted to any particular rack or carrier system but can handle any kind of source and target carrier. The system is thus ideal for use in combination with any analytical platform.

Sample tubes are loaded in bulk, closed, via the bulk loader (see previous page) or in racks, open or closed, via the loading platform.

ID modules are available for reading barcodes and for identifying tube types via a camera.

With the **decapper module**, caps and screw caps are safely removed and hygienically discarded.

On the **aliquoter**, barcoded secondary tubes are prepared and the requested volume is dispensed into them. Sample mix-ups are eliminated, and the available specimen volume is used most efficiently.

Two versions of **recapper modules are available** for archiving or shipping test samples. Tubes are closed either with an archiving cap (all diameters from 13–16 mm) or with a 13 or 15 mm diameter screw cap (SARSTEDT tubes).

The PVS **software** communicates with the laboratory information system (LIS) in query or batch mode (file-based).

The sample tubes are **sorted** according to the analysis task from the LIS or to specific sorting rules. All common racks and trays can be used as target carriers.





Our capillary blood collection systems, with nominal volumes of 100–600 μl , are among the most versatile on the market. Depending on requirements, choose between Microvettes with conical or round inner tubes and various different collection techniques – with a capillary straw or a collection rim. The Microvette® can also be used for open venous blood drip collection.

The Minivette® POCT was specifically developed to meet the demands of point-of-care diagnostics. It provides safe and hygienic handling along with precise dosage of the required test volume: 10 μl , 20 μl , 50 μl , 100 μl and 200 μl .

Reliable POCT diagnostics require simple yet precise blood volume collection and delivery products and methods.

The Sediplus® S 200 and Sediplus® S 2000 blood sedimentation devices provide automatic processing of samples. Optional modular extensions for up to 160 measuring positions are available if required.

The Blood Gas Monovette®, with a capacity of just 1 ml, minimizes diagnostic blood loss in patients who require special monitoring. In addition, the fluid-dosed Ca^{2+} balanced heparin ensures the rapid and optimal mixing of blood and anticoagulant.



Capillary blood	
Microvette®	36–37
Multivette® 600 & Microvette® CB 300	38
Minivette® POCT	39
Safety Lancets & Safety-Heel®	40
Thrombo Plus® and accessories for other diagnostics	41
Blood sedimentation	
S-Sedivette® & Sediplus®	42–44
Microvette® CB 200 ESR	45
Blood gas	
Blood Gas Monovette® & blood gas capillary sets	46–47

Microvette® 100/200 – blood collection with capillary



blood collection through the assembled 100 µl or 200 µl end-to-end capillary

Depending on individual requirements, choose between the Microvette® 100 and 200, with round or conical inner tubes. The capillary straw for blood collection based on the end-to-end principle is pre-assembled and ready for use.

The Microvette® 100/200 is characterized by the following benefits:

- pre-assembled end-to-end capillary
- easy to open and close
- cap design minimizes aerosol effect
- optimized tube geometry ensures thorough sample mixing
- color-coded caps and print for easy additive identification and nominal volume
- shelf life and batch number on every tube



The special cap design minimizes aerosol effects when the tube is opened and guarantees secure closure.



Pre-assembled end-to-end capillary and fill line. Shelf life and batch number on every tube.

Microvette® 100

100 µl nominal volume, conical inner tube

Order No.	Preparation
20.1280.100	Serum/coagulation activator
20.1282.100	Plasma/lithium heparin

100 µl nominal volume, round inner tube

Order No.	Preparation
20.1278.100	Hematology/potassium EDTA

The Microvette® 100 is packed 100/box, 1,000/case.

Microvette® 200

200 µl nominal volume, conical inner tube

Order No.	Preparation
20.1290.100	Serum/coagulation activator
20.1292.100	Plasma/lithium heparin
20.1289.100	Glucose/fluoride

200 µl nominal volume, round inner tube

Order No.	Preparation
20.1291	Serum gel/coagulation activator
20.1288.100	Hematology/potassium EDTA

The Microvette® 200 is packed 100/box, 1,000/case. For carrier tubes, see p. 21.

Microvette® 300/500 – blood collection with collection rim



Simple peripheral blood collection with ultra-thin collection rim

These Microvettes are ideal for collecting blood using any part of the thin rim.

The conical inner tube of the Microvette® 300 is designed for mixing and centrifugation of small blood volumes.



Nominal volume 300 µl or 500 µl with fill lines.
Shelf life and batch number on every tube.

The Microvette® 300/500 is characterized by the following benefits:

- choice of 300 µl or 500 µl inner tube volumes with corresponding fill lines
- easy to open and close
- tube geometry ensures thorough sample mixing
- cap can be attached to the tube base during collection to prevent cap mix-ups or loss
- shelf life and batch number on every tube

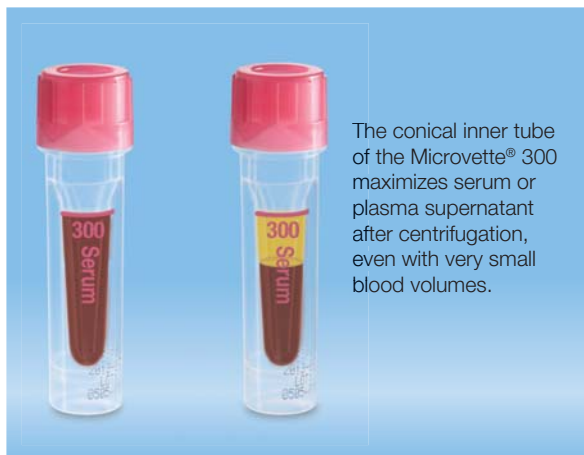

The conical inner tube of the Microvette® 300 maximizes serum or plasma supernatant after centrifugation, even with very small blood volumes.

Microvette® 300

300 µl nominal volume, conical inner tube

Order No.	Preparation	
20.1308.100	Serum/coagulation activator	
20.1309.100	Plasma/lithium heparin	
20.1307.100	Glucose/fluoride	

Microvette® 500

500 µl nominal volume, round inner tube

Order No.	Preparation	
20.1343.100	Serum/coagulation activator	
20.1344	Serum gel/coagulation activator	
20.1345.100	Plasma/lithium heparin	
20.1346.100	Plasma/lithium heparin gel	
20.1341.102	Hematology/potassium EDTA	

The Microvette® 300/500 is packed 100/folding box, 1,000/case.

Can be used as a primary tube or in combination with carrier tubes (see p. 21).

Multivette® 600 & Microvette® CB 300

Multivette® 600 – capillary and venous blood collection in one system

- Simple venous blood collection when combined with Luer needle
- Hygienic and safe capillary blood collection based on the end-to-end principle
- Volume can be checked against the fill marks
- Maximum capacity 600 µl

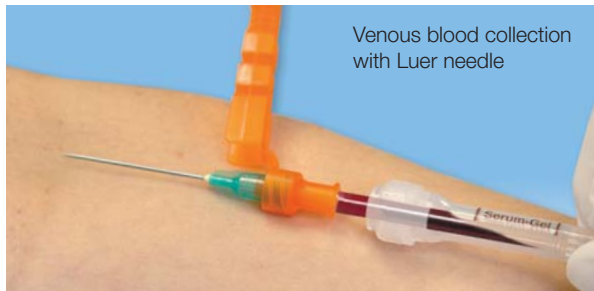

Order No.	Preparation	
15.1670.100	Serum/coagulation activator	
15.1674	Serum gel/coagulation activator	
15.1673.100	Plasma/lithium heparin	
15.1675.100	Plasma/lithium heparin gel	
15.1671.100	Hematology/potassium EDTA	
15.1672.100	Glucose/fluoride	

Multivettes are packed 100/folding box, 1,000/case.

Microvette® CB 300 – the system for maximizing serum/plasma yield

The collection capillary (with attached cap) is supplied in an outer tube that serves both for transportation and for centrifugation.

Following blood collection, the capillary is sealed on both ends with its attached caps.

The trumpet-shaped capillary ensures maximum serum/plasma yields following centrifugation.

- Maximized serum/plasma yields following centrifugation
- Collection and centrifugation in one tube
- Compatible with different analyzers as a primary tube for direct sampling



Order No.	Preparation	
16.440.100	Serum/coagulation activator	
16.441.100*	Serum/coagulation activator Amber tube	
16.443.100	Plasma/lithium heparin	
16.434.100*	Plasma/lithium heparin Amber tube	
16.444.100	Hematology/potassium EDTA	
16.446.100	Glucose/fluoride	

* Light-protective amber outer tube for bilirubin determination.
Microvettes are packed 100/bag, 1,000/case.

For carrier tubes, see p. 21.



Minivette® POCT

Collection and dispensing of small capillary whole blood samples for point-of-care tests.

- Simple sample recovery
- Precise dispensing of small whole blood samples
- Prevents spillage during transfer to test card

Order No.	Description	Color code	Packaging
17.2111.920	Minivette® POCT 20 µl, neutral, with cap		Individually wrapped, 100/box · 1,000/case
17.2111.010	Minivette® POCT 10 µl, neutral		200/box · 2,000/case
17.2111.020	Minivette® POCT 20 µl, neutral		
17.2111.050	Minivette® POCT 50 µl, neutral		
17.2111.100	Minivette® POCT 100 µl, neutral		
17.2111.200	Minivette® POCT 200 µl, neutral		150/box · 1,500/case
17.2112.120	Minivette® POCT 20 µl, lithium heparin		200/box · 2,000/case
17.2112.150	Minivette® POCT 50 µl, lithium heparin		
17.2112.101	Minivette® POCT 100 µl, lithium heparin		
17.2112.201	Minivette® POCT 200 µl, lithium heparin		
17.2113.120	Minivette® POCT 20 µl, potassium EDTA		200/box · 2,000/case
17.2113.150	Minivette® POCT 50 µl, potassium EDTA		

Example of use

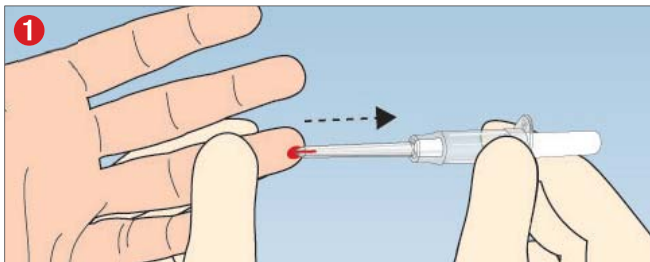

The Minivette® POCT is held on the sides below the wings, in a horizontal or slightly angled position. The ventilation hole at the piston end must not be covered when collecting drops of blood with the capillary tip. Do not push the piston down – fill the capillary, ensuring there are no air bubbles.

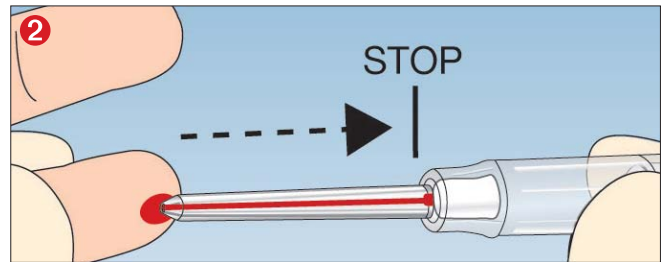

Blood collection ends automatically when the capillary is filled with blood to the white blocking filter.

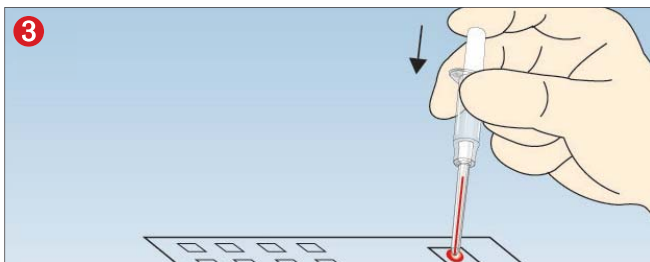

Place the capillary tip on the test field and dispense the complete blood sample by gently pressing the piston down.

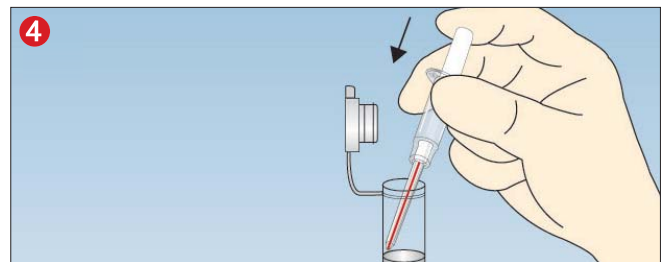

Alternatively, the sample can be dispensed into a micro sample tube.



Safety Lancet

For safe and gentle capillary puncture

The easy to handle Safety Lancet is primed and ready for use.

The needle or blade is concealed in the lancet body before and after use, reducing the risk of needlestick injuries and cross contamination.

The sterile device is controlled for single use only and can be safely discarded. A range of penetration depths and widths are available to accommodate various volume requirements and skin types, ensuring adequate blood flow.

- Safe for user and patient
- Patient-friendly handling
- Designed for targeted blood volumes

Order No.	Penetration depth (mm)	Type and needle size	Blood volume	Packaging
85.1015	1.6	Mini 28G	Low	200/box 1,200/case
85.1016	1.8	Normal 21G	Medium	200/box 1,200/case
85.1017	1.8	Extra 18G	Medium to high	200/box 1,200/case
85.1018	1.6	Super blade, approx. 1.50 mm wide	High	200/box 1,200/case
85.1019	1.2	Neonatal blade, approx. 1.50 mm wide	Medium to high	200/box 1,200/case



Safety-Heel® – incision lancet

Heel puncture for premature and newborn babies

Testing of premature and newborn babies by means of a heel puncture helps detect life-threatening congenital diseases. Heel puncture is often a painful procedure.

With the new SARSTEDT Safety-Heel® incision lancet, discomfort can be minimized and blood collection optimized. The semi-circular incision can help prevent the formation of hematomas.

- Easy to use
- Large contact area
- Optimum blood flow without additional massage, and with minimal penetration depth
- Adequate blood volume
- Significantly less pain
- Rapid healing due to low penetration depth

Order No.	Penetration depth (mm)	Type and needle size	Blood volume	Packaging
85.1022	1.0	Neonate blade, approx. 2.5 mm long	Medium to high	50/box 200/case
85.1023	0.85	Premature baby blade, approx. 1.75 mm long	Medium to high	50/box 200/case



Individual test for direct platelet counting

- Simple and quick
- Accurate count even with extremely low thrombocyte numbers
- Eliminates erythrocyte and leukocyte pipettes
- No need to for a humidity chamber
- Thrombocytes are visible with remarkable clarity in the counting chamber as glowing discs
- Sample is stable at 4°C for at least 24 hours

Thrombo Plus®

Order No.	Length/Ø in mm	Packaging units/case
51.334	75/11.5	500



Tube type 1
With push cap

Tube type 2
With push cap and upper barrier membrane

Micro sample tubes for determination of glucose or HbA_{1c}

Predosed micro sample tubes with hemolysis solution

The predosed volume can be checked against the printed tube markings at any time. The tubes are packed 100 units per PE bag.

Order No.	Cap color/predosed with	Dosage/capillary	Tube type	Packaging units/case
41.1438.904	yellow Hemolysis solution (SARSTEDT) for glucose	1,000 µl/20 µl	1	1,000
41.1178.903	neutral Hemolysis solution (DiaSys) for glucose	1,000 µl/20 µl	1	1,000
41.1438.901	neutral Hemolysis solution (Roche gen. 2) for glucose	500 µl/20 µl	2	1,000
41.1443.904	yellow Hemolysis solution (e.g. ESAT)	1,000 µl/20 µl	2	1,000
41.1496.911	black Hemolysis solution (Roche) for HbA _{1c}	1,000 µl/10 µl	1	1,000

* For carrier tubes, see p. 21

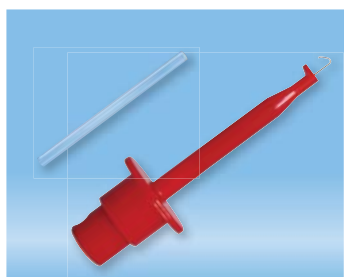

End-to-end capillaries

Order No.	Collection volume	Preparation	Packaging units/box
19.414	10 µl	NH ₄ heparin	100
19.447	20 µl	Potassium EDTA	100

For safe handling of capillaries, the red capillary holder illustrated is ideal.

Order No.: 95.1048 Packaging: 5/bag



Sample tube for reticulocyte counting

A 1% brilliant cresyl blue solution is used as a color reagent. 100 µl of this reagent is predosed into the reagent tube, to which 100 µl EDTA venous blood is added. After a reaction time of 15-30 minutes, the smear can be prepared.

Micro tube with brilliant cresyl blue

Order No.	Material	Packaging units/case
42.117	Polypropylene	500



Closed system for blood sedimentation

- Blood collection using the proven S-Sedivette®
- Sedimentation measurement in the collection tube
- No need to transfer blood samples or use sedimentation pipettes
- Hygienic, easy to use
- Economical and time-saving

S-Sedivette®

Order No.: 06.1690.100

Packaging: 500 pcs./case

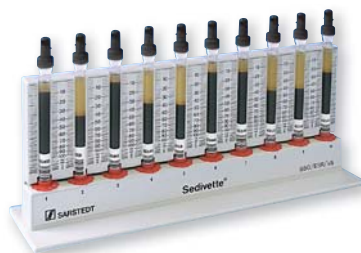

Sedimentation rack with graduations

Order No.: 90.1090



Sediplus® S 200

- For use with the S-Sedivette®
- The calculated value corresponds directly to Westergren values, in mm
- 10 samples can be measured simultaneously and independently
- Digital display of measured values and times via a multi-functional display
- Interfaces for LIS/printer and keyboard/BC reader

Order No.	Description
90.189.900	Sediplus® S 200, 100-240 V AC 50/60 Hz

Sediplus® S 2000

- 40-channel closed ESR device for S-Sedivettes
- The calculated value corresponds directly to Westergren values, in mm
- 40 samples can be measured simultaneously and independently
- Digital display of measured values and times via a multi-functional display
- Interfaces for LIS/printer and keyboard/BC reader
- 40-position expansion modules can be added for up to 160 positions

Order No.	Description
90.189.700	Sediplus® S 2000, 100-240 V AC 50/60 Hz
90.189.710	40-channel expansion module



Test-Sedivette®

- For functional tests on the Sediplus® S 2000

Order No.	Description
91.189.715	Test-Sedivette® for Sediplus® S 2000

SediTest

- For functional tests on the Sediplus® S 200

Order No.	Description
92.189.915	SediTest S 200 for Sediplus® S 200

Thermo printer

- For printing measurement data from the Sediplus® S 100, S 200 and S 2000

Order No.	Description
90.189.725	Thermo printer with 115/6 plug and connection cable
90.188.055	5x paper rolls for thermo printer

Barcode scanner

- For sample identification on the Sediplus® S 2000 or S 100/S 200

Order No.	Description
90.189.730	Barcode scanner for Sediplus® S 2000/S 200/S 100

Sediplus® data manager

- Multifunctional interface for Sediplus® S 100, S 200 and S 2000

Order No.	Description
90.189.750	Sediplus® data manager

Sarmix® M 2000

- Rotating mixer for hematology and research applications

Order No.	Description
90.180.600	Sarmix® M 2000
92.180.615	Block rotor for 40 tubes up to Ø 8.5 mm (S-Sedivette®)

Sediplus® blood sedimentation system



Combined system for safe blood collection and sedimentation

- Automatic and manual Westergren-compatible determination
- Safety closure in sedimentation pipette prevents blood leakage
- Easy adjustment of blood column with screw thread
- Bubble-free filling of pipettes
- Sedimentation pipettes with assembled piston insert

Order No.	Description	Packaging units/case
05.1079.100	S-Monovette® ESR, 2 ml, 66 x 11 mm, with paper label	500
47.410.100	Prepared screw cap tube, 2 ml, ESR, 66 x 11 mm, with paper label	500
86.1996	Sedimentation pipette with O marking	1,000
86.1996.062	Sedimentation pipette with printed graduations	1,000
90.189.800	Sediplus® S 100 for automatic determination of ESR	1
90.1060	ESR rack with graduated back wall	1
90.1060.062	ESR rack without back wall (for pipettes with graduations)	1

Automatic and manual Westergren-compatible determination

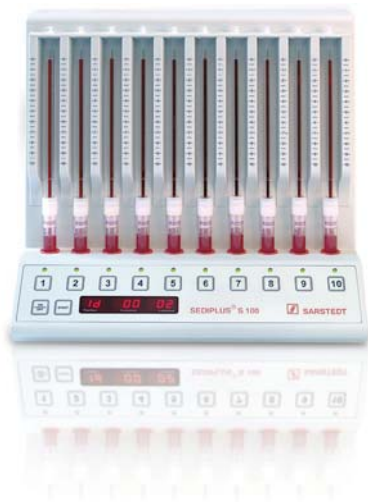

Sediplus® S 100

Order No.: 90.189.800

- Sediplus® blood sedimentation system for S-Monovette® ESR with Westergren pipette.
- 10 samples can be measured simultaneously and independently
- Digital display of measured values and times via the multi-functional display

ESR rack with graduated back wall

Order No.: 90.1060

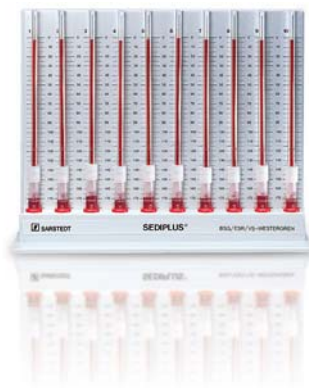

ESR rack without back wall

(for pipettes with graduations)

Order No.: 90.1060.062



For more information, visit our website:
www.sarstedt.com.



Microvette® CB 200 ESR

Measurement of capillary blood sedimentation

The Microvette® CB 200 ESR, pre-dosed with citrate, comes with a cap with an integral and prepared end-to-end collection capillary and a sedimentation capillary.

- Proven comparability to the Westergren method
- Minimizes patient discomfort with a collection volume of just 200 µl

Order No.	Description	Packaging units/case
18.1325.100	Microvette® CB 200 ESR	500

ESR rack

- The ESR rack with graduated back wall and 10 measuring positions is designed specifically for the Microvette® CB 200 ESR.

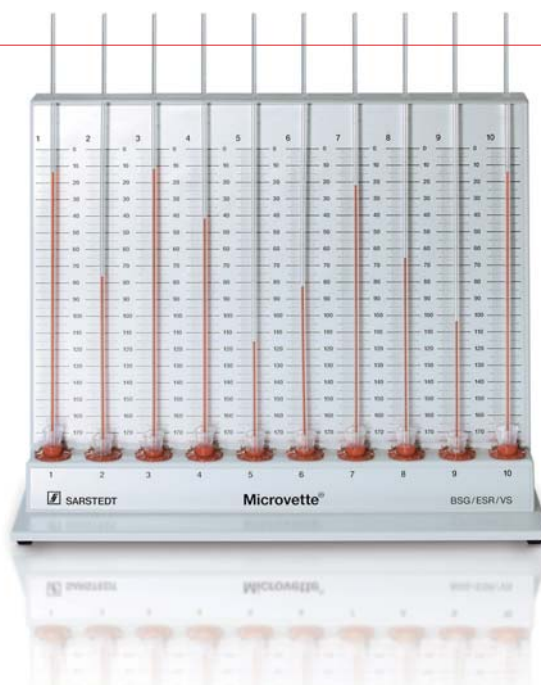

ESR rack for Microvette® CB 200

Order No.	Material	Description	Packaging units/case
90.1091	Plastic	ESR rack for Microvette® CB 200	1



Venous and arterial blood sampling

The Blood Gas Monovette® is available in 1 and 2 ml options for venous and arterial blood collection.

The Ca²⁺ balanced heparin is also suitable for determining electrolytes. The blood-gas Monovette® is prepared with liquid heparin. Anticoagulant: Ca²⁺-balanced heparin; 50 I.E. heparin/ml blood.

(see the following study: Gruber et al, Clinica Chimica Acta 395 (2008) 187)

Order No.	Description	Nominal volume	Packaging box/case
05.1146	Blood gas Monovette®	1.0 ml	50/500
05.1146.020	Blood gas Monovette®	1.0 ml	100/500, individually wrapped sterile
05.1147	Blood gas Monovette®	2.0 ml	50/500
05.1147.020	Blood gas Monovette®	2.0 ml	100/500, individually wrapped sterile
05.1147.028	Blood gas Monovette® with membrane adapter	2.0 ml	100/500, individually wrapped sterile
05.1147.048	Blood gas Monovette® with ventilator	2.0 ml	100/500, individually wrapped sterile
14.1148	Ventilator		500/1,000
14.1112	Membrane adapter		100/1,000



Blood gas capillary, PET plastic

- Break-resistant
- Low gas permeability
- Anticoagulant: Ca²⁺-balanced heparin; 70 I.E. heparin/ml blood
- Range of volumes

Order No.	Description	Ø/Length mm	Packaging units/case
19.930.100	Plastic blood gas capillaries 100 µl	2.05/100	250
19.930.125	Plastic blood gas capillaries 125 µl	2.05/110	250
19.930.140	Plastic blood gas capillaries 140 µl	2.3/75	200
19.930.175	Plastic blood gas capillaries 175 µl	2.3/100	200

Suitable transport container, order no. 95.997, see page 71.
PET = Polyethylene terephthalate



Blood gas capillary sets

- Convenient pack includes capillaries, caps, and mixing wires

Order No.	Description	Packaging units/case
51.931.100	Blood gas capillary set 100 µl	1,000
51.931.125	Blood gas capillary set 125 µl	1,000
51.931.140	Blood gas capillary set 140 µl	800
51.931.175	Blood gas capillary set 175 µl	800

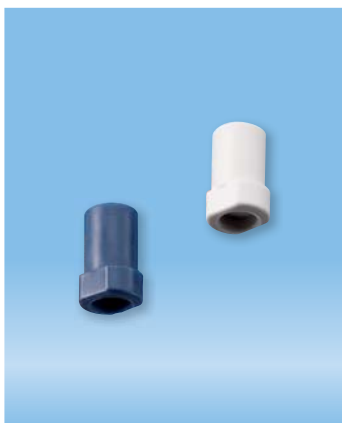

Caps

- Two sizes to fit SARSTEDT blood gas capillaries
- Flexible TPE material provides secure closure
- Oblong shape for optimum grip

Order No.	Description	Packaging units/case
65.935.205	White cap for blood gas capillary with external Ø 2.05 mm	500
65.935.230	Blue cap for blood gas capillary with external Ø 2.3 mm	400



Mixing wire and bell-shaped magnet

- Mixing wire compatible with all SARSTEDT blood gas capillaries
- Easy to grip, ergonomically-shaped red magnet

Order No.	Description	Packaging units/case
95.936	Mixing wires, Ø 1 mm, length 9 mm	250
95.937	Bell-shaped magnet, red	10

Suitable transport container, order no. 95.997, see page 71.



To meet pre-analytical requirements for hygienic collection and safe transportation of diagnostic samples, SARSTEDT offers high quality products for collecting urine, feces, saliva, CSF, and tissue samples.

Small- and large-volume urine collection vessels are available for daily urine diagnostics and are ideally complemented by the UriSet 24. This set covers a complete 24-hour collection period, with simultaneous urine stabilization.

For hygienic collection of stool samples, all collection vessels are equipped with integral spoons. The screw cap stool containers with broad, non-deforming scoops facilitate particularly convenient sample collection.

Clear and sterile containers are particularly suitable for CSF. The use of appropriate materials such as polypropylene meets the *guidelines of the German Association of Liquid Diagnostics and Clinical Neurochemistry (DGLN)* and ensures standardized CSF collection.

The Salivette® enables simple, hygienic collection of saliva for diagnosis and therapy control of various parameters. Particularly relevant is the determination of cortisol, for which a particular swab material is specified.

Our closed Formalin System maximizes user protection from dangerous formalin fumes while allowing the contamination-free fixing of tissue samples.



Urine, feces,
saliva and CSF

Urine	
Urine Monovette® & conical urine tubes	50–51
V-Monovette® Urine & accessories	52–53
Urine collection bottles	54
UriSet 24	55
Urine cups and urine containers	56–57
Feces	
Fecal tubes and Hemoplus® test	58–59
Saliva	
Salivette®	60
CSF	
Fluid/CSF Monovette® and fluid/CSF tubes	60
Tissue	
Formalin system	61



Urine Monovette® for hygienic urine collection, transport, and analysis

Three functions in one:

- **Hygienic urine collection and transport:** Urine can be collected from any sample container. A Luer-lock version allows direct, needle-less connection to catheter ports. The piston snaps off after collection for transport and further processing.
- **Vessel for test strips:** Test strips can be immersed directly into the filled Urine Monovette®.
- **Centrifuge tube for sedimentation:** The Urine Monovette® can be used for recovering sediment in the centrifuge.

Order No.	Volume in ml	Tube length/Ø in mm	Description	Packaging units/case
10.250.001	3.2	75/13	Paper label	512
10.258	8.5	92/15	---	512
10.258.020	8.5	92/15	Individually wrapped, sterile	500
10.252	10	102/15	---	512
10.252.028	10	102/15	With luer-lock adapter, individually wrapped, sterile	100
10.252.030	10	102/15	White, UV light protection	512
10.252.020	10	102/15	Individually wrapped, sterile	500



Urine Monovette® with stabilizer

for bacteriological urine analysis

- The Urine Monovette® prepared with boric acid effectively stabilizes microorganisms from sample collection to analysis.
- The bacteriostatic effect of boric acid on the most important causes of urinary tract infections has been proven.
- Urine collection and sample transport in a single container.

Order No.	Volume in ml	Tube length/Ø in mm	Description	Packaging units/case
10.253	10	102/15	---	512
10.253.001	10	102/15	Paper label	512
10.253.020	10	102/15	Individually wrapped, sterile	500
10.253.021	10	102/15	Paper label, individually wrapped, sterile	500

Single suction tip

Order No.	Length in mm	Ø in mm	Packaging units/case
10.251	76	8	5,000

Conical urine tubes



Urine tube with stabilizer

- for bacteriological urine analysis

Volume in ml	Order No. Material	Tube length/Ø in mm	Description	Packaging units/case
30	51.9923.820 PP	90/25	With boric acid 1.5% or 10 mg/ml	500



Tubes with conical base, push cap

Volume in ml	Order No. Material	Length/Ø in mm	Packaging units/case	Compatible cap no.*
12	57.462.300 PS	110/17	1,000	65.793.300 65.816
	57.462.015 PS		1,000 ☒	
	57.527.300 PP with graduations		1,000	
12	57.462.001 PS sterile, not illustrated	110/17	500	Cap assembled, sterile
10	62.9924.272 PP with graduations and writing space	100/16	1,000	65.793.300 65.816 65.720
4.5	57.477 PS	75/12	2,000 ☒	65.809.300 65.719
	57.512 PP		4,000	



Tubes with conical base, screw cap, graduations and writing space

Volume in ml	Order No. Material	Tube length/Ø in mm	Packaging units/case	Description
15	62.554.101 PP	120/17	50/bag 500/case	Red cap included
15	62.554.205 PP	120/17	50/bag 500/case	Red cap assembled, sterile, non-pyrogenic, non-cytotoxic
15	62.553.001 PS	120/17	50/bag 500/case	Red cap included
15	62.553.205 PS	120/17	50/bag 500/case	Red cap assembled, sterile, non-pyrogenic, non-cytotoxic
10	62.9924.293 PP	100/16	1,000/case	Natural cap included
10	62.9924.294 PP	100/16	100/bag 1,000/case	Yellow cap assembled, sterile

For screw cap tubes with conical bases in 30 ml and 50 ml sizes, see pp. 86–87.

PS tubes with conical base with skirt, screw cap

Volume in ml	Order No. Material	Tube length/Ø in mm	Packaging units/case	Description
10	60.9921.821 PS	97/16	1,000/case	Natural cap included
10	60.9921.830 PS	97/16	100/bag 1,000/case	Yellow cap assembled
10	60.9921.829 PS	97/16	100/bag 1,000/case	Yellow cap assembled, sterile

☒ = StackPack

PS = transparent polystyrene, PP = translucent to opaque polypropylene

* For illustration of caps see pp. 90–91.

Urine, feces,
saliva and CSF

The vacuum system for closed urine transfer

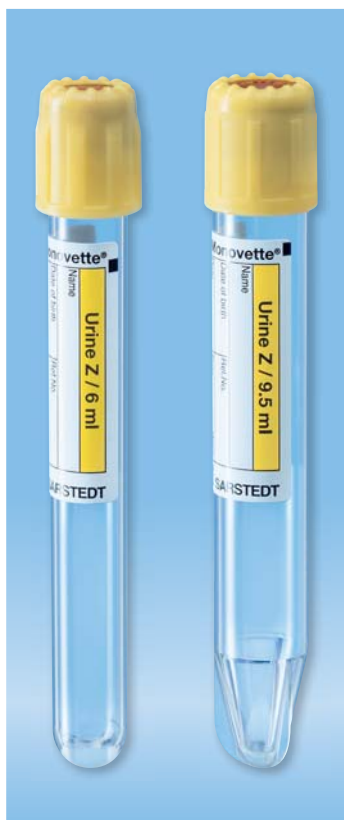

Urine analysis • V-Monovette® Urine without preparation, round base, paper label, sterile

Order No.	Description	Tube length/Ø in mm	Packaging units/case
11.2252.001	V-Monovette® Urine Z 4 ml	75/13	500
11.2352.001	V-Monovette® Urine Z 6 ml	100/13	500
11.2452.001	V-Monovette® Urine Z 10 ml	100/15	500

V-Monovette® Urine without preparation, conical base, paper label, sterile

- The ideal centrifuge vessel for sediment collection
- Improved centering in rack due to flanges in the tapered base
- Suitable for a KOVA pipette for standardized analysis of urine sediment

Order No.	Description	Tube length/Ø in mm	Packaging units/case
11.2552.001	V-Monovette® Urine Z 9.5 ml	100/15	500



Urine culture • V-Monovette® Urine with stabilizer, round base, paper label, sterile

- Stabilizes the microorganisms in the urine in a closed system
- When filled to the nominal volume, the urine is effectively stabilized for up to 48 hours at room temperature

Order No.	Description	Tube length/Ø in mm	Packaging units/case
11.2253.001	V-Monovette® Urine 4 ml with boric acid	75/13	500
11.2453.001	V-Monovette® Urine 10 ml with boric acid	100/15	500

Urine transfer



100 ml urine cup with integral transfer device

- Recessed transfer device to protect against injury
- Safety label with sharp hazard warning
- Safety label guarantees sterility
- Stackable, highly transparent
- Closed urine transfer for volumes above 20 ml

Order No.	Description	Height/Ø in mm	Packaging units/case
75.562.400	100 ml urine cup with integral transfer device	72/62	200



3 liter urine collection bottle with integral transfer device

- Convenient horizontal transfer for volumes > 1200 ml. The integral transfer device is always located on the opposite side of the handle.
- Inverted transfer of smaller volume samples above 700 ml
- Ergonomic recessed handle for secure handling
- Transparent volume inspection strip with 100 ml graduations
- Large diameter opening (80 mm)
- Volume 3 l

Order No.	Description	Height in mm	Packaging units/case
77.575.401	3 l urine collection bottle with integral transfer device, with self-adhesive label included	255	30

Self-adhesive label for urine collection bottle

for 77.575.401, 77.575.001, and 77.580

- Single labels with instructions for 24-hour urine collection

Order No.	Description	Packaging
84.1402.001	Size 150 x 55 mm	300/box (10 x 30/bag) 1,800/case



Transfer straw

- Urine transfer from open containers for small volumes < 20 ml
- 10 cm straw length
- Wings on tube holder enable one-handed operation
- Compatible with all V-Monovette® Urine tube sizes

Order No.	Description	Packaging units/case
11.1240	Transfer straw, straw length 10 cm	500

Urine collection bottles



3 liter PE urine collection bottle with yellow screw cap

- Volume 3000 ml
- Ergonomic recessed handle for secure handling
- Large-diameter opening
- Transparent volume inspection strip

Order No.	Volume	Description	Packaging units/case
77.575.001	3.0 liters	Supplied with self-adhesive label	30

Self-adhesive label for urine collection bottle

for 77.575.001, 77.575.401, and 77.580

- Single labels with instructions for 24-hour urine collection

Order No.	Description	Packaging
84.1402.001	Size: 150 x 55 mm	300/box (10 x 30/bag) 1,800/case



PE urine collection bottle with yellow screw cap

Order No.	Volume	Description	Packaging units/case
77.580	2.0 liters	Supplied with self-adhesive label	30

Self-adhesive label for urine collection bottle

for 77.575.001, 77.575.401, and 77.580

- Single labels with instructions for 24-hour urine collection

Order No.	Description	Packaging
84.1402.001	Size: 150 x 55 mm	300/box (10 x 30/bag) 1,800/case



PE urine collection bottles with black screw cap

Order No.	Volume	Description	Packaging units/case
77.582	0.5 liters	Brown	100
77.577	0.25 liters	White	120

PE = polyethylene

UriSet 24

Complete set for standardized, patient-friendly 24-hour urine collection

- Collection bottle**
 with 3000 ml capacity, ergonomic handle, large-diameter (80 mm) opening and transparent volume inspection strip.
- Collection and transfer container**
 An integrated 500 ml collection cup enables patient-friendly collection and transfer of the urine from the collection bottle to the transport tube.
- Stabilizer**
 Hydrochloric acid (9 ml, 20%) predosed into a glass bottle with safety dropper is included in the set, eliminating steps and improving patient safety. The quantity and concentration of hydrochloric acid ensures urine stabilization for up to 7 days for the analysis of catecholamines, metanephrines, vanillylmandelic acid, homovanillic acid and 5-hydroxyindoleacetic acid. The long period of stability at room temperatures allows the samples to be collected in the laboratory with efficient batch processing.
- Transport tube or Urine Monovette®**
 Only the enclosed 30 ml tube or Urine Monovette® is returned to the doctor or laboratory. The urine collection bottle remains with the patient for disposal. The collection bottle does not require disposal by the doctor or laboratory. A self-adhesive label is enclosed with the transport container for patient identification.



500 ml collection cup

Stabilizer

30 ml transport tube

10 ml Urine Monovette®, white

UriSet 24

Order No.	Description	Packaging units/case
77.578	With stabilizer and 30 ml transport tube	30
77.578.252	With stabilizer and white Urine Monovette®	30
77.578.010	Without stabilizer, with white Urine Monovette®	30

Separate 500 ml urine collection cup

Order No.	Length in mm	Opening Ø in mm	Packaging units/case
75.1356	148	80	250

Separate transport tubes

Order No.	Volume in ml	Length/Ø in mm	Description	Packaging units/case
10.252.030	10	102/15	Urine Monovette®, white	512
62.543.030	30	107/25	Tube, white, with screw cap	500

Urine cups – with and without snap-on lids



250 ml PS cup, white

Order No.	Length in mm	Opening Ø in mm	Packaging units/case
75.560	100	73	500

PS snap-on lid

76.561	---	---	500
--------	-----	-----	-----



125 ml PP cup, neutral

Order No.	Length in mm	Opening Ø in mm	Packaging units/case
75.565	85	62	500



125 ml PP cup, highly transparent

Order No.	Length in mm	Opening Ø in mm	Packaging bag/case
75.1355	67	66	50/1000

PE snap-on lid, red

Order No.	Description	Pcs./bag	Packaging units/case
76.1477	With spout	1,000	1,000
76.1477.100	With spout	100	
76.1414	Without spout	1,000	
76.1414.100	Without spout	100	



100 ml PS cup, white

Order No.	Length in mm	Opening Ø in mm	Packaging units/case
75.570	49	70	1,000

PS snap-on lid

76.571	---	---	1,000
--------	-----	-----	-------



500 ml PP cup

- For holding full quantities of urine when collecting multiple samples of urine

Order No.	Length in mm	Opening Ø in mm	Packaging units/case
75.1356	148	80	250

PE = polyethylene, PP = polypropylene, PS = transparent polystyrene

Urine cups – with screw cap



90 ml PP urine cup, with dual-click screw cap

Order No.	Length/Ø in mm	Description	Packaging units/case
75.1435.004	65/60	Cup with cap assembled, sterile, label	400



100 ml transparent PP cup, HD-PE screw cap, neutral

Order No.	Length/Ø in mm	Description	Packaging bag/case
75.563	72/62	Cup without cap	50/500
76.564	14/62	Screw cap	50/500
75.562.105	73/62	Cup with cap assembled, sterile, with safety label	5/200
75.562.005	73/62	Cup with cap assembled	5/200
75.562.300	72/62	Cup with cap unassembled	50/250

100 ml screw cap cup, brown

- Light protection for urine samples, e.g. for light-sensitive crosslinks for deoxypyridinoline assay

Order No.	Length/Ø in mm	Description	Packaging bag/case
75.562.011	72/62	Brown cup and cap, cap unassembled	50/250



70 ml cup with yellow screw cap assembled

- Highly transparent PP cup with HD-PE cap for reliable closure
- For urine, sputum or pathology samples

Order No.	Volume in ml	Length/Ø in mm	Description	Packaging units/case
75.9922.744	70	55/44	Cap assembled	500
75.9922.745	70	55/44	Cap assembled, with standard label	500
75.9922.721	70	55/44	Cap assembled, sterile, individually wrapped with standard label	200



Tubes with conical skirted base and screw cap

Order No.	Material	Volume in ml	Length/Ø in mm	Description	Packaging units/case
62.543 with printed graduations	PP	30	107/25	Cap assembled	500
62.543.001 with printed graduations	PP	30	107/25	Cap assembled, sterile	400
60.9922.241	PP	25	90/25	Cap assembled	500
63.9922.252	PP	25	90/25	Cap assembled, with label	500
60.9922.243	PP	25	90/25	Yellow cap assembled, sterile	500
63.9922.254	PP	25	90/25	Yellow cap assembled, with label, sterile	500
60.732	PP	15	76/20	Cap unassembled	500
60.732.001	PP	15	76/20	Cap assembled, sterile	500

HD-PE = high density polyethylene, PP = polypropylene
For more containers and cups see pp. 108-109.



Feces tubes with screw cap

Order No.	Length/Ø in mm	Tube material	Description	Packaging units/case
80.622	107/25	PP	Sterile	400
80.622.111	107/25	PP	Non-sterile	500
80.623	101/16.5	PP	Sterile	500
80.623.111	101/16.5	PP	Non-sterile	500
80.734.001	76/20	PP	Sterile	500
80.734	76/20	PP	Non-sterile	500
80.734.311	76/20	PP	Sterile, with label	500
80.734.301	76/20	PP	Non-sterile, with label	500
80.734.401	76/20	PP, white	Non-sterile, with label	500

For appropriate transport containers for feces tubes, see pp. 67-69.
All feces tubes can be supplied with custom print or labels on request.

Feces tube with flat base and push cap (not illustrated)

Order No.	Length/Ø in mm	Tube material	Description	Packaging units/case
80.621	75/23.5	PS	Sterile	250
80.620	75/23.5	PS	Non-sterile	500



Feces tube with screw cap for collecting a defined stool sample

This feces tube is for clean and simple collection of a defined stool sample of 1 ml or approximately 1 g.

The stool scoop capacity is 1 ml; any excess is removed using an included spatula. The scoop is securely fixed into the cap and reaches to the middle of the tube.

The design enables centrifugation and supernatant separation without disturbance upon opening.

Example of use:

Immunological procedure to detect occult blood

Add e.g. 2 ml distilled water into the feces tube and mix to produce a suspension.

After centrifugation, the supernatant can be analyzed immunologically for target proteins, e.g. hemoglobin and albumin.

Literature on this procedure is available on request.

Order No.	Length/Ø in mm	Tube material	Description	Packaging units/case
80.623.022	101/16.5	PP	Feces tube, inc. spatula	1,000

PS = transparent polystyrene, PP = polypropylene



25 ml and 70 ml feces containers

The 25 and 70 ml containers are made of robust white polypropylene and the brown HDPE screw cap has an integral stool scoop. The containers are primarily used for collecting stool samples for pathology, but are also suitable for grain and soil samples.

Order No.	Material	Volume	Length/Ø in mm	Description	Packaging units/case
80.9924.014	PP	25	54/28	White with brown scoop cap and label	500
80.9924.027	PP	70	55/44	White with brown scoop cap and label	500

PP = polypropylene

Hemoplus® test

Guaiac resin test for detecting occult blood in feces



- **No risk of mix-ups**

One Hemoplus® test card contains all 12 test positions for an analysis period. This eliminates the risk of mixing the test cards with those of other patients.

- **Balanced test sensitivity**

Hemoplus® does not detect normal physiological blood loss. The test sensitivity is specific for colorectal cancer screening. The test principle relies on evidence of pseudoperoxidase activity in the hemoglobin. The 12 test positions on each card contain filter paper with guaiac resin to act as an indicator. The developing reagent contains a stabilized alcoholic hydrogen peroxide solution. If blood is present in the stool, hemoglobin catalyzes the oxidation of the guaiac resin by the hydrogen peroxide in the developing reagent to form a blue-colored compound.

Test design

- **Multiple applications**

Each test card can be separated into three sections for single or multiple tests.

- **High accuracy**

Every card section has 4 test fields, increasing the probability of detecting a positive result in a non-homogeneous stool sample.

- **Easy to read**

A positive result is clearly indicated by blue coloration, which is visible for at least 60 seconds.

Order No.	Description	Packaging units/case
51.1444.001	Hemoplus® test – 50 test cards (each with 12 cardboard spatulas) and one test card for 3 stool tests – 2x30 ml bottles of developing reagent – 1 comprehensive set of instructions	1

Salivette® · Sputum and CSF containers

Using the Salivette®, saliva is simply and hygienically collected by chewing on a swab. The saturated swab is placed into the Salivette® insert and centrifuged to recover clear saliva for analysis.



Salivette®

Saliva tests are valuable diagnostic and therapeutic tools for many different diseases.

- **Economical**
The sample can be collected at home or by untrained staff.
- **Acceptable to patients**
Sampling is painless and easily repeated.
- **Transportable**
The Salivette® is easily and safely transported to the laboratory.
- **Hygienic**
The special design of the Salivette® ensures clean and hygienic sampling.
- **Sample Quality**
Following centrifugation, a crystal-clear fluid is available for analysis. It is not necessary to freeze the fresh saliva, which is often required with other collection methods.

Order No.	Length/Ø in mm	Color	Description	Packaging
51.1534	97/16.8	Natural 	Cotton swab, plain	100/bag 500/case
51.1534.500	97/16.8	Blue 	Synthetic fiber swab for cortisol determination	100/box 500/case



Sputum tubes, individually wrapped sterile

Volume in ml	Order No. Material	Length/Ø in mm	Description	Packaging units/case
25	63.9922.248 with standard label PP	90/25	Yellow cap assembled, individually wrapped, sterile	300
15	62.553.020 with writing space and graduations PS	120/17	Yellow cap assembled, individually wrapped, sterile	500



Fluid/CSF Monovette® and fluid/CSF tube

The transparent sterile containers are especially suitable for CSF, since premium material properties are vital for analyte recovery (e.g. low concentration proteins). Screw caps allow the fluid containers to be securely closed for transportation and storage.

CSF: Cerebrospinal fluid

Volume in ml	Order No. Material	Length/Ø in mm	Description	Packaging units/case
10	10.252.027 PP	102/15	Monovette® with paper label, individually wrapped, sterile, blue Luer screw cap	500
12	60.9924.952 (styrene acrylonitrile) SAN	99/16	Round base, graduated, set of four tubes, sterile, yellow screw cap	250
10	62.610.018 PP	92/15.3	Round base, graduated, individually wrapped, sterile, screw cap	500

PP = polypropylene, PS = transparent polystyrene

Formalin System

Closed Formalin System · Protection from toxic formalin fumes



The SARSTEDT Formalin System is a closed system, enabling contamination-free fixation of tissue specimens without contact with formalin. Unlike conventional methods, the tissue specimen is placed into a neutral, plain S-Monovette®. The S-Monovette® is then connected to the SARSTEDT Formalin System and filled with formalin to fix the sample.

- **Occupational safety**

Our closed Formalin System prevents the spread of dangerous formalin fumes while allowing the contamination-free fixing of tissue samples

- **Flexible formalin dosing**

The user determines the formalin volume, resulting in considerable cost reduction for formalin and its disposal

Order No.	Description	Sales unit
51.1703	Formalin System with 450 ml formaldehyde solution (4%)	6 pc.
51.1703.009	Formalin Set 9 ml: Formalin System and 100 S-Monovettes 9 ml	1 set
51.1703.025	Formalin Set 25 ml: Formalin System and 50 S-Monovettes 25 ml	1 set
09.1704.001	S-Monovette® 9 ml, 92 x 16 mm, 50/bag	500 pc.
09.1705.001	S-Monovette® 25 ml, 97 x 25 mm, 50/bag	250 pc.
95.1706	Wall holder for Formalin System	1 piece

Urine, feces,
saliva and CSF

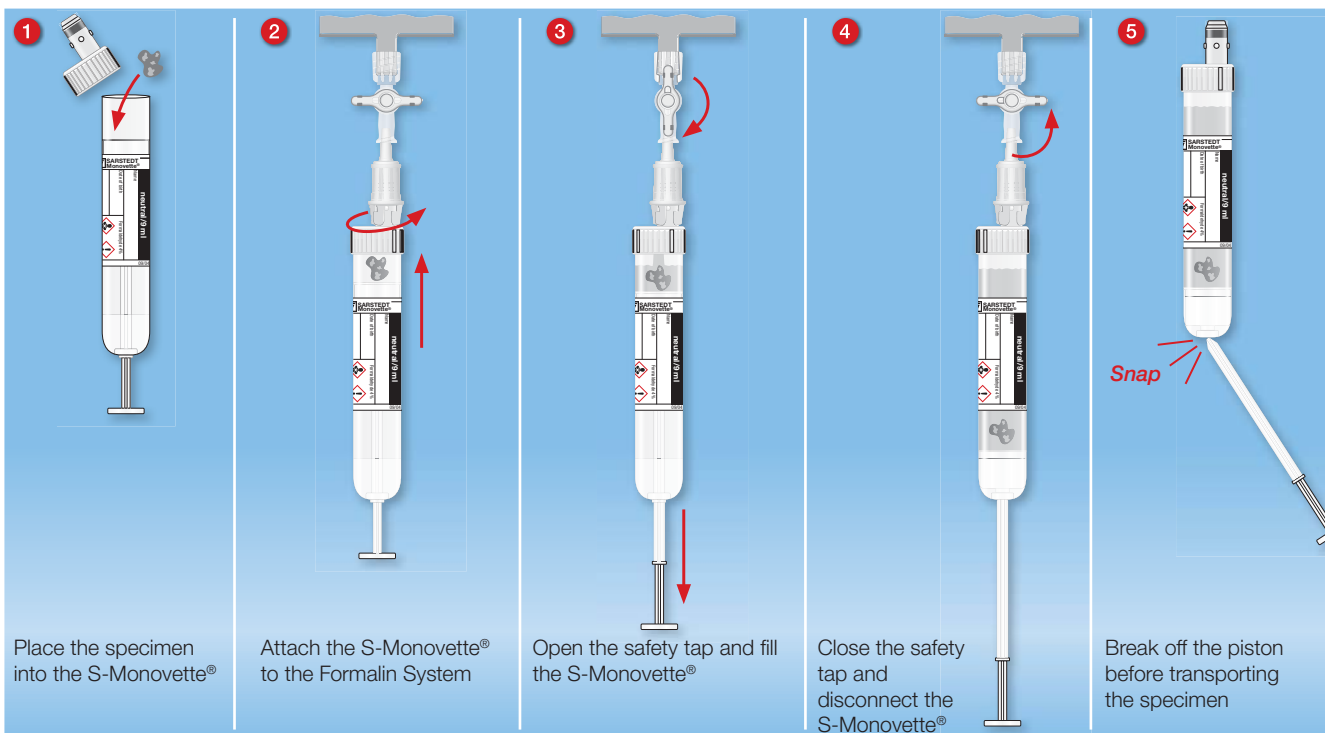

Our extensive product range of Multi-Safe* disposal boxes meets disposal requirements for medicine and laboratory equipment. From the handy 200 ml format to the autoclavable 60 l disposal box for clinical waste, we offer the ideal solution for every need while ensuring safe disposal of needles and sharps. All Multi-Safe disposal boxes are made of polypropylene (PP) for environmentally friendly incineration.

Our transportation boxes and cases are type-tested sample transportation systems for delivering diagnostic samples.

Transport containers conform to IATA/ADR packing instruction P650 and can therefore be used to transport diagnostic specimens of substance class UN3373. These boxes are also a compliant system under the regulations of Deutsche Post AG and can be shipped as "exempt medical specimens" ('P650 light'). Combined with the individual components in accordance with packing instruction P650, the transport cases form an ideal system for safe courier transport (ADR) of substance class UN3373 samples. The cases are approved by the German Federal Institute for Material Research and Testing (BAM), and offer an excellent option for shipping a large number of samples.

** Multi-Safe disposal boxes are not available in every country.*



Sample transportation	
Transport cases, PE mailing envelopes	64–65
Mailing boxes and PE mailing envelopes for postage	66
Mailing containers – rectangular	67
Mailing containers – round	68–69
Mailing containers for cold and warm transport	70–71
Disposal	
Multi-Safe disposal boxes	72–76
Safety Tray phlebotomy tray	77

Transport case for in-house sample transport

For simple and safe transport of samples within the hospital or laboratory; compliant with TRBA 100 section 6.1.4.

- Hardshell case made from shatter-proof ABS*
- Capacity of 50 or 100 S-Monovettes, tubes, or swabs, depending on the version
- Large case with removable insert for simple handling and disinfection



Order No.	Description	External dimensions
95.1720	Transport case for in-house transport of samples, pale gray lid and base, removable insert for 2 block racks	360 x 310 x 275 mm
95.1720.011	Transport case for in-house transport of samples, transparent lid, pale gray base, capacity for 1 block rack	270 x 170 x 220 mm

*ABS = acrylic butadiene styrene



Transport cases for courier transportation of diagnostic samples

The courier transport case packing system provides safe transportation of diagnostic samples of substance class UN3373. The system is fully compliant with the IATA/ADR packing instruction P650 and has been approved by the German Federal Institute for Material Research and Testing (BAM).

- Options include a wide-mouth container or plastic bag with clip closure
- Compact superabsorber pack is highly absorbent
- Outer packaging with highly effective insulating foam

Order No.	Description	Packaging units/case
95.1715	Transport case T 15, secondary packaging; wide-mouth container, inc. Superabsorber Pack with UN3373 marking	1
95.1717	Transport case B 17, secondary packaging; plastic bag with clip closure, inc. Superabsorber Pack with UN3373 marking	1
95.1717.011	Transport case B 13, low height version for 1 layer of block racks, otherwise identical to B 17 with UN3373 marking	1
95.1717.003	Transport case B 19, without lateral rim, for block rack with handle, otherwise identical to B 17 with UN3373 marking	1
95.1712	Superabsorber Pack, approx. 1.2 l capacity	100
95.1713	Plastic bag 270 x 270 x 600 x 0.1 mm	25
95.1714	220 mm clip closure	25
95.1725	Insulated bag for icepacks	12



PE mailing envelope

- Durable plastic sheets
- Convenient separation of samples and documents
- Max. document size A4
- Especially suitable for pneumatic tube delivery systems

2 compartments for sample tubes, each sealed with a self-adhesive strip that is reversible and can be reused multiple times.

Order No.	Size	Packaging units/case
86.974	440 x 320 x 0.2 mm	300

Mailing boxes for postal use



Mailing box for safe postage of diagnostic samples

- Compliant with the regulations of Deutsche Post AG and with IATA/ADR packing instruction P650
- Can be used for all SARSTEDT mailing containers on pp. 67–69
- Integrated restraints or a foam bag ensure that the secondary containers are securely held and protected
- Custom print available on request, minimum order 15,000 pcs.

Order No.	Size	Description	Packaging
95.900	198 x 107 x 38 mm	Suitable for 1–4 mailing containers up to 30 mm diameter, depending on size; with UN3373 marking	50 pcs./case (flat, not folded)
95.901	198 x 107 x 50 mm	Suitable for 1–4 mailing containers up to 44 mm diameter, depending on size; with UN3373 marking	50 pcs./case (flat, not folded)
95.902	220 x 170 x 40 mm	Suitable for 1–10 mailing containers up to 30 mm diameter, depending on size; foam bag enclosed; with UN3373 marking	50 pcs./case (flat, not folded)
84.1412.033	145 x 98.5 mm	Self-adhesive label with 'Exempt Human Specimen' print	1,000 pcs./case



Universal post and transport box

- Compliant with IATA/ADR packing instruction P650
- Suitable as an outer packaging for cold transport containers (see p. 70)

Order No.	Size	Description	Packaging
95.903	192 x 146 x 77 mm	Suitable for 1–16 mailing containers up to 44 mm diameter, depending on size; with UN3373 marking	50 pcs./case (flat, not folded)
95.1710	185 x 230 mm	Individual foam bag	200 pcs./case



PE mailing envelopes for postal use

- Made of blue, tear-resistant PE sheeting
- Self-adhesive labels with custom print are available, minimum order 10,000 pcs.
- Labels are removable so the envelopes can be reused multiple times
- Envelopes available in two sizes

Order No.	Size	Description	Packaging units/case
95.1410	310 x 180 mm	2 rows, 3 perforations	1,000
95.1411	310 x 123 mm	1 row, 3 perforations	1,000
84.1412.033	145 x 98.5 mm	Address label with 'Exempt Human Specimen' print	1,000

Self-adhesive labels 145 x 98.5 mm, custom printed on request.
PE = polyethylene

Mailing containers for diagnostic specimens

Mailing containers for safe transport of primary blood, urine, swab and stool sample tubes.

A tightly sealed screw cap allows quick and easy opening and closing. Containers are stackable, due to rectangular design. HD-PE container and closure, neutral.

Containers are available with and without an absorbent liner

Mailing containers can be custom printed, ie. with a private address, for a minimum quantity of 10,000 pcs.



Mailing container 114 x 28 mm with screw cap

- Suitable for all S-Monovettes and tubes up to 25 mm diameter

Order No.	Internal length in mm	Opening Ø in mm	Description	Packaging units/case
78.572	114	28	Without absorbent liner	250
78.573	114	28	With absorbent liner	250

Mailing container 176 x 28 mm with screw cap

- Suitable for all S-Monovettes and tubes up to 25 mm diameter, and for swabs

Order No.	Internal length in mm	Opening Ø in mm	Description	Packaging units/case
78.574	176	28	Without absorbent liner	250
78.574.500	176	28	With absorbent liner	250

Internal length = max. length of the tube to be posted.

Opening Ø = max. diameter of the tube to be posted.

HD-PE: high density polyethylene

Mailing containers – round

Safe, secure, and convenient mailing packaging for diagnostic specimens

The mailing containers are suitable for transporting diagnostic samples. Leakproof at a pressure difference of 95 kPa, they are ideal for use as secondary containers in compliance with IATA/ADR packing instruction P650. The protective containers and screw caps are made from environmentally neutral polypropylene and are autoclavable up to 121 °C (see important note on p. 219). Custom print available on request, minimum quantity 10,000 pcs. The mailing containers are available with or without absorbent liners. The absorbent liners are also available separately. According to P650, an absorbent liner must always be present between the primary and secondary packaging. The containers with a diameter of 30 mm fit into conventional letterboxes with a 35 mm slot.

Please note:

Containers and screw caps must be ordered separately. The 114 x Ø 44 mm container is suitable for mailing common culture media packs (e.g. the Uricult system). The 126 x Ø 30 mm container can be used with special cap no. 65.731 for Port-A-Cul tubes.



Mailing container 126 x Ø 30 mm

Order No.	Description	Packaging units/case
78.896	Without absorbent liner	250
78.898	With absorbent liner	250

Standard screw cap for container 126 x Ø 30 mm

Order No.	Color	Packaging units/case
65.679	Neutral	250
65.679.001	Brown	250
65.679.002	Red	250
65.679.004	Yellow	250

Special screw cap for container 126 x Ø 30 mm, for Port-A-Cul tube

Order No.	Color	Packaging units/case
65.731	Neutral	250

Mailing container 85 x Ø 30 mm

Order No.	Description	Packaging units/case
78.890	Without absorbent liner	500
78.892	With absorbent liner	500

Screw cap for container 85 x Ø 30 mm

Order No.	Color	Packaging units/case
65.676	Neutral	500
65.676.001	Brown	500

Absorbent liners

Order No.	For container size	Packaging units/case
78.670	126 x Ø 30 mm	4,000
78.684	85 x Ø 30 mm	2,000

Mailing containers – round



Mailing container 114 x Ø 44 mm

Order No.	Description	Packaging units/case
78.895	Without absorbent liner	250
78.897	With absorbent liner	250

Screw cap for container 114 x Ø 44 mm

Order No.	Color	Packaging units/case
65.678	Neutral	250

Absorbent liner

Order No.	For container size	Packaging units/case
78.669	114 x Ø 44 mm	1,000

Sample transportation and disposal

Mailing containers – examples of compatible primary tubes

- For sample tubes of 16.5 or 25 mm diameter, the screw caps can also be used as a support base.



For compatible boxes and mailing envelopes, see pp. 65-66.

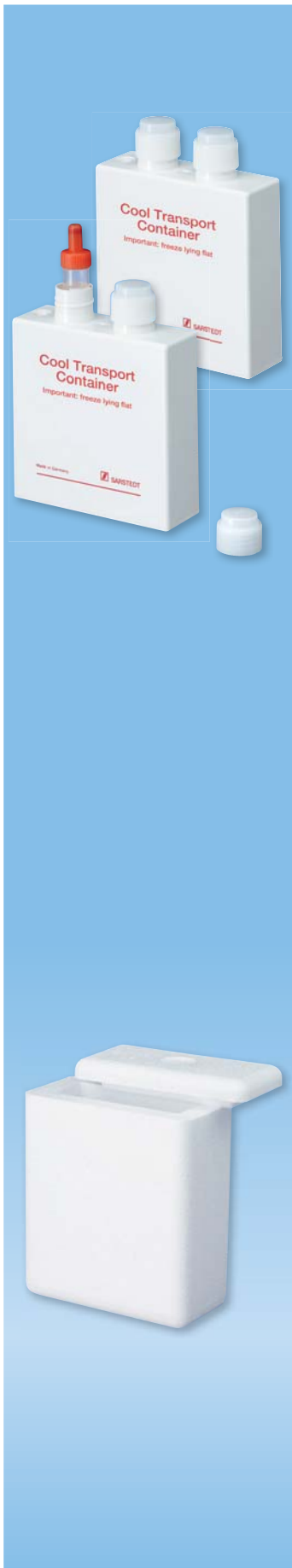

Mailing packaging for cold transport

The Cool Transport Container can be used for safe cold transport of medical and biological test specimens.

The mailing container can accommodate two 10 ml sample tubes and is also suitable for the 9 ml S-Monovette® or for tubes up to 16.5 mm diameter and 107 mm total length.

The mailing container is filled with a liquid coolant and must be frozen in a horizontal position at -12°C or below before mailing. The temperature in the sample tube over time is illustrated below.

The Styrofoam shell provides protection from heat and damage.

Custom print is available on request, minimum quantity 100 pcs.

The Cool Transport Container is not suitable for samples that must not freeze, as an unfrozen sample would freeze in this container.

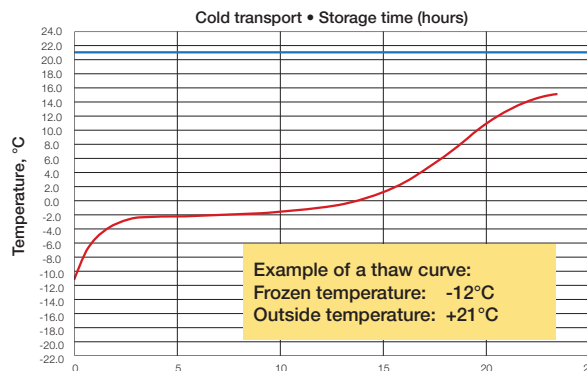

Example of a thaw curve

Sample: tube filled with 10 ml water, frozen

Measurement: thermosensor in sample

Frozen temperature: -12°C

Outside temperature when thawed: 18°C–21°C

Complete Cool Transport Container: includes mailing container with coolant, Styrofoam packaging and rubber band

Order No.	Packaging units/case
95.1123	6

Replacement Styrofoam packaging with rubber band

Order No.	Packaging units/case
95.1011	36

Mailing box for Cool Transport Container

- Outer box for transport in accordance with ADR packing instruction P650.

Order No.	Packaging units/case
95.903	50 (flat, not folded)

Absorbent liner for Cool Transport Containers

Order No.	Packaging units/case
78.671	2,500

Mailing containers



Cold & warm transport container

Because of its size, the cold and warm transport container is ideal for in-house transport (e.g. pneumatic tube) and is also suitable for road transport (conforming to IATA/ADR packing instruction P650).

The transport container can accommodate blood gas capillaries and S-Monovettes up to 105 mm in length and 18 mm in diameter. A retainer in the screw cap can secure a sample tube with a size of approx. 95 mm or more. A Styrofoam shell also provides protection and temperature control. The product is reusable. Examples of applications are shown below.

Order No.	Description	Dimensions	Packaging
95.997	Cold and warm transport container for blood gas capillaries and S-Monovette®	50 x 50 x 140 mm	1/box • 6/case

Cold transport:

- Stabilization of ammonia (NH₃)
- Stabilization of blood gas

The oxygen content can be maintained for 30 min. during cold transport.*

* Use of anticoagulants in diagnostic laboratory investigations; WHO/DIL/LAB/99.1 Rev.2.

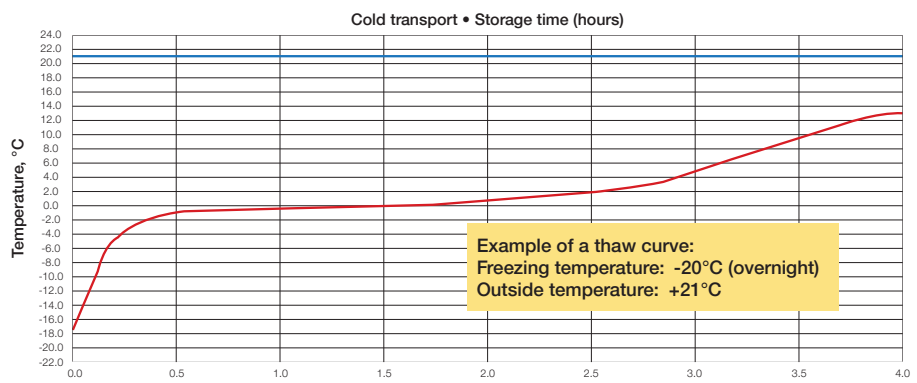

Warm transport:

- Cold agglutinins

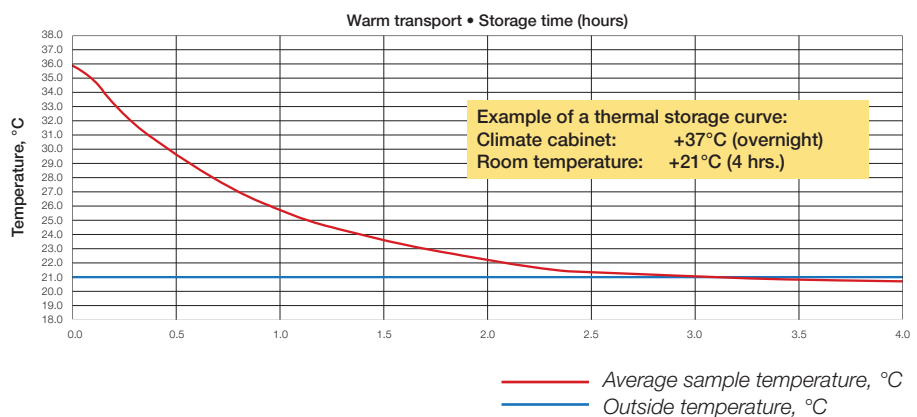

PP mailing containers for slides

The mailing containers are suitable for the transport or storage of two slides (or four, placed against one another). The lid is available with and without a shielded ventilation opening.

Order No.	Description	Packaging units/case
86.972	With ventilation	400
86.972.150	Without ventilation	400

PP = Polypropylene

Multi-Safe disposal boxes

SAFE disposal options

Our prevention strategy for avoiding needlestick injuries is to provide a wide product range for safe and optimal handling that satisfies guidelines and requirements.

Benefits of Multi-Safe disposal boxes:

- Various sizes for user-friendly disposal of sharps and needles in hospital wards and out-patient facilities
- On all versions with an oval day lid, the size of opening can be varied with perforated sections (except on 'vario')
- Range of holders (see p. 76) for secure fixation at various locations (except opti 500 T, a special design for injection trays)
- The higher-volume, large footprint boxes (medi, eco, steri and Multi-Safe) are stackable and do not require holders
- Additional retainers enable secure transport (see p. 76)
- Multi-Safe disposal boxes are dimensionally stable and made of high-grade polypropylene for resistance against breakage and stress fractures
- All containers can be autoclaved in an open state
- Depending on box version, the following removal aids are built in (see legend below):

A: Luer systems

B: insulin pens

C: scalpels, needles, Luer systems

D: scalpels

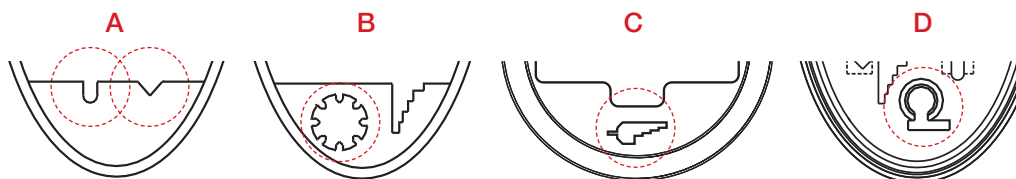

Certifications

- TRBA 250, ISO 23907 also available with separate absorbent layer, UN, AFNOR (separate art. numbers)



Multi-Safe disposal boxes



Multi-Safe sani 0.2 L & mini 0.3 L

- Convenient for mobile use
- Ideal for rescue teams



	Order No.	Description	Removal system	Packaging
1	77.3890.002	Multi-Safe sani 200	A	110/case
2	77.3890.003	Multi-Safe mini 300	A	135/case

Multi-Safe quick 0.5 • 1.0 • 1.5 • 2.0 • 2.5 L & quick S 1.5 • 2.0 • 2.5 L

- Small opening on the quick
- Large opening on the quick S with break-open lid
- Round shape



	Order No.	Description	Removal system	Compatible holder*	Packaging
3	77.3891.005	Multi-Safe quick 500	A, B, C	a, e	170/case
4	77.3891.010	Multi-Safe quick 1000	A, B, C	a, e	100/case
5	77.3891.015	Multi-Safe quick 1500	A, C	a, e, g	105/case
6	77.3891.020	Multi-Safe quick 2000	A, C	a, e, g	80/case
7	77.3891.025	Multi-Safe quick 2500	A, C	a, e, g	50/case
8	77.3892.015	Multi-Safe quick S 1500	A, B, C	a, e, g	80/case
9	77.3892.020	Multi-Safe quick S 2000	A, B, C	a, e, g	65/case
10	77.3892.025	Multi-Safe quick S 2500	A, B, C	a, e, g	45/case

Multi-Safe vario 1.5 • 2.3 L

- Very large opening
- Suitable for small, irregularly shaped waste
- Oval shape



	Order No.	Description	Removal system	Compatible holder*	Packaging
11	77.3893.015	Multi-Safe vario 1500	A, B, C	c, d, f	60/case
12	77.3893.023	Multi-Safe vario 2300	A, B, C	c, d, f	45/case

* see p. 76

Multi-Safe disposal boxes



Multi-Safe twin 0.7 • 1.8 • 2.1 • 3.0 • 5.0 L

- The 5 L box is suitable for the disposal of long-handled objects
- Oval shape

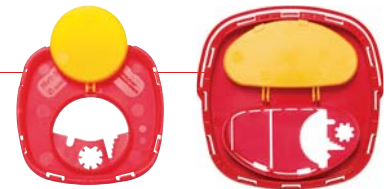

Order No.	Description	Removal system	Compatible holder*	Packaging
13 77.3894.007	Multi-Safe twin 700	A, B, C	a, e	200/case
14 77.3894.018	Multi-Safe twin 1800	A, B, C	a, e, h	100/case
15 77.3894.021	Multi-Safe twin 2100	A, B, C	a, e, h	100/case
16 77.3894.030	Multi-Safe twin 3000	A, B, C	a, e, h	60/case
17 77.3894.050	Multi-Safe twin 5000	A, B, C	a, e, h	45/case

Multi-Safe opti 0.5 T • 0.7 • 1.7 • 2.1 • 3.0 L

- The opti 500 T is ideal for phlebotomy and injection trays
- Oval shape



Order No.	Description	Removal system	Compatible holder*	Packaging
18 77.3895.005	Multi-Safe opti 500 T	A, B	—	110/case
19 77.3895.007	Multi-Safe opti 700	A, B, C	a, e, g	170/case
20 77.3895.017	Multi-Safe opti 1700	A, B, C	a, e, g	110/case
21 77.3895.021	Multi-Safe opti 2100	A, B, C	a, e, g	80/case
22 77.3895.030	Multi-Safe opti 3000	A, B, C	a, e, g	50/case

Multi-Safe euroMatic® 3.0 • 4.0 • 6.0 • 7.0 L

- Innovative day lid and permanent closure with single-handed operation (the day lid flips up automatically at the push of a button)
- Square shape



Order No.	Description	Removal system	Compatible holder*	Packaging
23 77.3897.030	Multi-Safe euroMatic® 3000	A, C, D	b, e	55/case
24 77.3897.040	Multi-Safe euroMatic® 4000	A, C, D	b, e	50/case
25 77.3897.060	Multi-Safe euroMatic® 6000	A, C, D	b, e	40/case
26 77.3897.070	Multi-Safe euroMatic® 7000	A, C, D	b, e	37/case

* see p. 76

Multi-Safe disposal boxes



Multi-Safe medi 6 • 11 L

- For large volume waste
- Carrier handle for easy transportation

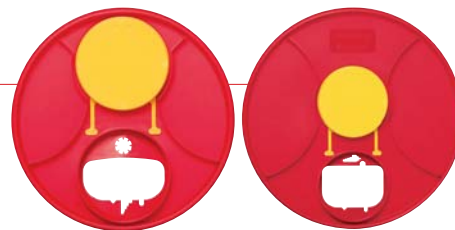

Order No.	Description	Removal system	Packaging
27 77.3898.006	Multi-Safe medi 6	A, B, C	576/pallet
28 77.3898.011	Multi-Safe medi 11	A, C	330/pallet
29 77.3898.106	Multi-Safe medi 6 with handle	A, B, C	576/pallet
30 77.3898.111	Multi-Safe medi 11 with handle	A, C	330/pallet
31 77.3898.206	Multi-Safe medi 6, handle, label	A, B, C	384/pallet (24/case)

Sample transportation
and disposal

Multi-Safe eco 25 • 50 L & Multi-Safe 25 • 50 L

- A safe, secure, and liquid-tight seal (silicone rim) is guaranteed
- Stackable whether empty or full
- Disposal of clinical waste
- Lid-in-lid system reduces the opening size. Both lids have a silicone rim for leak-proof permanent closure.
- No holders needed

Order No.	Description	Packaging
32 77.3899.025	Multi-Safe eco 25	160/pallet
33 77.3899.050	Multi-Safe eco 50	125/pallet
34 77.3899.125	Multi-Safe 25	160/pallet
35 77.3899.150	Multi-Safe 50	125/pallet

Multi-Safe disposal boxes

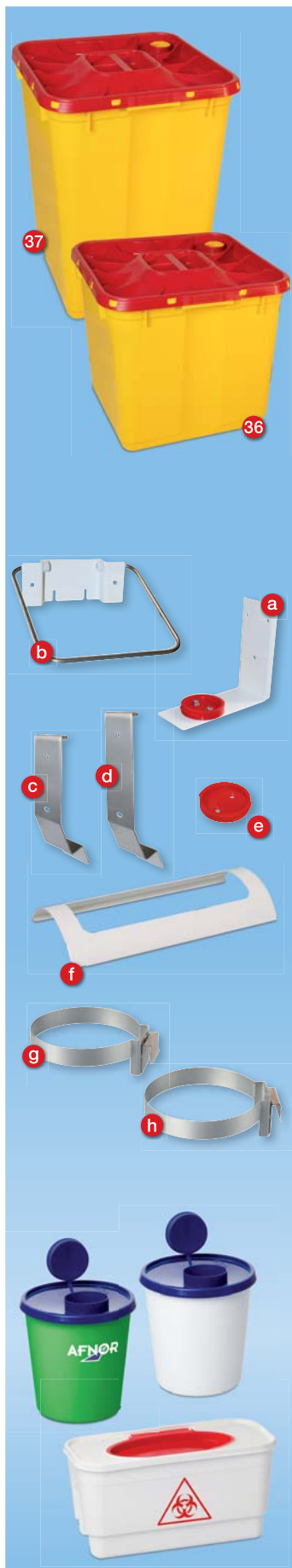

Multi-Safe steri 35 • 60 L

- Ideal solution for infectious waste disposal. It is robust enough to withstand sterilization in an autoclave at 121°C or 134°C.
- No holders needed

Order No.	Description	Packaging
36 77.3899.035	Multi-Safe steri 35	150/pallet
37 77.3899.060	Multi-Safe steri 60	120/pallet

Multi-Safe holders

Order No.	Description	Packaging
a 95.963	Wall holder	30
b 95.963.001	Wall holder euroMatic®	20
c 95.963.015	Wall holder vario 1500	25
d 95.963.023	Wall holder vario 2300	30
e 95.965.001	Adhesive adapter	150
f 95.965.003	Table holder vario	1
g 95.963.003	Wall holder for Dräger rail (internal Ø 130 mm)	10
h 95.963.004	Wall holder for Dräger rail (internal Ø 140 mm)	10

Customized Multi-Safe disposal box

- Quantity-dependent, custom-made Multi-Safe disposal boxes (e.g. different colors, personalized labels etc.) are possible.

Please contact **SARSTEDT Customer Service** or download our **Multi-Safe brochure** (www.sarstedt.com) for more details.

Safety Tray – efficient design for improved organization

Tailored for blood collection, the Safety Tray configuration is adjustable for specific requirements.

Note: The accessories illustrated are not part of the standard delivery and must be ordered separately.



Order No.	Description		Packaging
93.1650	Safety tray without insertion plate 429 x 283 x 80 mm		1/case
93.1650.010	Description I 1 x S-Monovette® rack D17 with handle 2 x dispenser box with lid 1 x Multi-Safe opti 700 3 x multi-purpose cup 1 x disinfection spray		1/case
93.1650.020	Description II 2 x dispenser box with lid 1 x Multi-Safe vario 1500 6 x multi-purpose cup 1 x disinfection spray		1/case
93.1650.030	Description III 2 x dispenser box with lid 1 x Multi-Safe opti 700 8 x multi-purpose cup 1 x disinfection spray		1/case
93.1650.040	Description IV 1 x S-Monovette® rack D17 with handle 2 x dispenser box with lid 1 x Multi-Safe vario 1500 1 x multi-purpose cup 1 x disinfection spray		1/case
93.1650.050	Description V 1 x S-Monovette® rack D17 with handle 1 x dispenser box with lid 1 x Multi-Safe box twin 1800 4 x multi-purpose cup 1 x disinfection spray		1/case

Accessories

Order No.	Description	Description	Packaging
77.3895.007	Multi-Safe opti 700	0.7 L suitable for versions I and III	200/case
77.3893.015	Multi-Safe vario 1500	1.5 L suitable for versions II and IV	60/case
77.3894.018	Multi-Safe twin 1800	1.8 L suitable for version V	100/case
95.813.001	Dispenser box	With lid for Safety Tray	35/case
75.1355.100	Multi-purpose cup	125 ml for Safety Tray	1,000/case
93.851	Rack D17	With handle, gray	12/case
93.851.171	Rack D17	With handle, red	
93.851.172	Rack D17	With handle, yellow	
93.851.173	Rack D17	With handle, green	
93.851.174	Rack D17	With handle, blue	
93.851.175	Rack D17	With handle, orange	



Safe and robust top-quality containers are essential for mixing, preparing and storing samples. As one of the largest manufacturers in the world of tubes and storage vessels, we offer extensive options for the various needs in laboratory and analysis work.

Our broad product range of reagent and centrifuge tubes with round, conical or flat bases, with or without skirted bases, with push or screw caps, is complemented with printed, labeled, or individually packaged options.

Our micro screw cap tubes with maximum security seals are especially suitable for small volumes. End users have relied upon them for over 40 years, as centrifuge tubes or transportation and storage containers, for high-grade synthesized oligonucleotides, enzymes and buffers. Our push cap micro tubes, available in various versions and colors, are the ideal containers for virtually any routine application at small volumes of up to 2 ml.

The CryoPure system facilitates secure storage at ultra-low temperatures. Our Microtest and DeepWell plates are ideal for assays at a microliter scale and space-saving sample storage. Large volumes can be stored in multi-purpose cups and containers. Our product range is complemented with corresponding storage boxes and racks for tubes and micro tubes.



Test and centrifuge tubes	80–92
Tubes with round bases	80–84
Tubes with conical bases	85–87
Tubes with flat bases	88–89
Push caps	90–91
Mixing instruments	92
Screw cap micro tubes	93–99
Push cap micro tubes	100–103
CryoPure freezing system	104–105
Micro test plates	106
DeepWell plates (MegaBlock®)	107
Multi-purpose cups and containers	108–109
Storage boxes	110–111
Racks	112–117

Test and centrifuge tubes with round base



Test and centrifuge tubes in compact StackPacks

All tubes with the ☒ symbol are supplied in convenient StackPacks.

These tubes can also be supplied bulk packed in bags.

Comparison of case volumes:

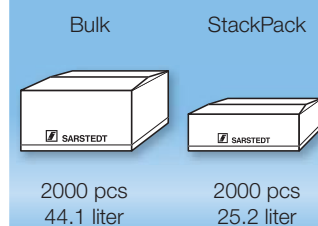

Tubes with round base, push caps sold separately

Volume in ml	Order No.	Material	Tube length/Ø in mm	Packaging units/case	Compatible cap no.*
30	55.517	PP	95/24.8	500	65.791
26	55.471	PS	87/23.5	500	65.790
20	55.465 55.514	PS PP	100/21.5	500 1,000	65.529
16.5	55.460 55.510	PS PP	130/17	1,000	65.793.300 65.816 65.720
14	55.461 55.511	PS PP	119/15.5	1,000	65.793.300 65.816 65.720
14	55.463 55.538	PS PP	105/16.8	1,000 ☒ 1,000	65.793.300 65.816 65.720
13	55.459 55.515	PS PP	100/16	1,000	65.793.300 65.816 65.725 **
13	55.468 55.468.005 55.518	PS PS PP	95/16.8	1,000 ☒ 1,000 1,000	65.793.300 65.816 65.720
13	62.492 with writing space and graduations	PS	95/16.8	1,000	65.793.300 65.816 65.720
11.5	55.466 55.466.005 55.539 55.539.250	PS PS PP PP	100/15.7	1,000 ☒ 1,000 1,000 1,000 ☒	65.803.300 65.802 65.727
11	55.474 55.524	PS PP	82/16.8	1,000	65.793.300 65.816 65.720
9	55.481 55.533	PS PP	67/16.8	2,000	65.793.300 65.816 65.720
8.5	55.495 55.598.006	PS PP	75/15.7	2,000 1,000	65.803.300 65.802 65.727
8	55.467.300 55.467.006 55.516.300	PS PS PP	100/13	2,000 ☒ 2,000 2,000	65.806.300 65.818 65.724
8	55.473	PS	84/14.5	2,000	65.804.300
7	55.482	PS	65/15.7	2,000	65.803.300 65.802 65.727
6.5	55.472 55.522.300	PS PP	85/13	2,000	65.806.300 65.818 65.724

PS = transparent polystyrene, PP = polypropylene

☒ = StackPack

* For cap illustrations see pp. 90–91.

** Cap 65.725 fits the 100/16 PP tube only, not the PS tube

Test and centrifuge tubes with round base



Tubes with round base, push caps sold separately

Volume in ml	Order No. Material	Tube length/Ø in mm	Packaging units/case	Compatible cap no.*
5	55.475.300 PS	75/13	2,000 ☐☐☐	65.806.300 65.818 65.724
	55.475.305 PS		2,000	
	55.525 PP		2,000 ☐☐☐	
	55.525.005 PP		2,000	
5	62.493.300 with writing space and graduations PS	75/13	2,000	65.806.300 65.818 65.724
5	55.476.300 PS	75/12	2,000 ☐☐☐	65.809.300 65.719
	55.476.305 PS		2,000	
	55.526.300 PP		4,000 ☐☐☐	
	55.526.305 PP		4,000	
5	62.476.322 with writing space and graduations PS	75/12	2,000	65.809.300 65.719
4	55.655 PS	50/14	3,000	65.804.001
3.5	55.484 PS	55/12	4,000 ☐☐☐	65.809.300 65.719
	55.484.005 PS		4,000	
	55.535.300 PP		5,000	
3	55.528 PP	75/10	2,000	65.782

Sample handling



Tubes with round base, push-cap assembled, sterile

Volume in ml	Order No. Material	Tube length/Ø in mm	Packaging units/case	Cap color
13	55.468.001 PS	95/16.8	500	Neutral
5	55.475.001 PS	75/13	1,000	Neutral
3.5	55.484.001 PS	55/12	2,000	Neutral

Other sterile, assembled tubes are available on request.

PS = transparent polystyrene

PP = polypropylene

☐☐☐ = StackPack

* For cap illustrations see pp. 90-91.

Test and centrifuge tubes with round base



Tubes with assembled, two-position ventilation cap, sterile

1st position: Cap lightly engaged ventilated

2nd position: Cap firmly engaged sealed

Volume in ml	Order No. Material	Length/Ø in mm	Description	Packaging	units/case
5	55.526.006 PP 55.476.013 PS	75/12	Cap assembled, sterile	25/bag	1,000
5	62.526.028 PP 62.476.028 PS	75/12	Cap assembled, printed graduations, sterile	1/blister	500
13	62.515.006 PP	100/16	Cap assembled, printed graduations, sterile	25/bag	500
13	62.515.028 PP	100/16	Cap assembled, printed graduations, sterile	1/blister	500

Ventilation cap, LD-PE

Order No.	Suitable for tube size	Packaging
65.722	75/12 mm Ø	5,000
65.725	100/16 mm Ø	5,000

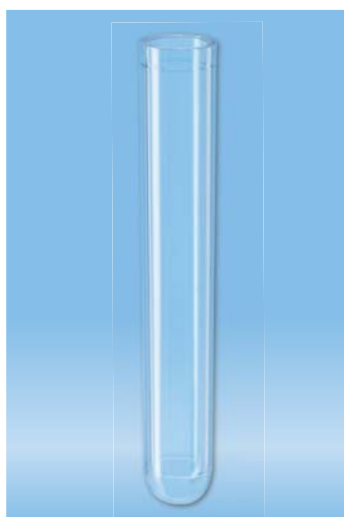

Tubes for specific analyzers, no caps

Volume in ml	Order No. Material	Length/Ø in mm	Description	Packaging units/case
5	55.1578 highly transparent PP	75/12	Tube for flow cytometer FACScan	2,000
5	55.476.061 PS	75/12	Tube for Vitek and Vitek 2 by bioMérieux	500/StackPack, 2,000/case
5	55.1579 PS	75/12	Tube for flow cytometers FACSAria, FACSCanto, FACSCalibur, LSR II, FC500	500/StackPack, 2,000/case
5	55.1579.002 PS	75/12	Tube for flow cytometers FACSAria, FACSCanto, FACSCalibur, LSR II, FC500, sterile	50/bag 1,000/case
5	55.526.053 PP	75/12	Tube for Abbott m1000	500/StackPack, 2,000/case
5	55.475.200 PS	75/13	Tube for Tecan Genesis, FE500	490/StackPack, 1,960/case



Conical tube for Pharmacia/LBK and Packard Cobra gamma counters, caps sold separately

- With narrow base tip for optimum sediment recovery
- Transparent polypropylene
- Suitable for all rack and instrument types, both old and new

Volume in ml	Order No. Material	Length/Ø in mm	Packaging units/case	Compatible cap no.*
4.5	57.477.500 PP	75/12	4,000	65.809.300 65.719

Glass tubes for Coombs test

- Uniform wall thickness, secure packaging

Volume in ml	Order No.	Length/Ø in mm	Packaging units/case
5	86.1509	75/11.5	294/box, 2,352/outer case

PS = transparent polystyrene, PP = polypropylene, LD-PE = low density polyethylene
* For cap illustrations see pp. 90-91.

Test and centrifuge tubes with round base



PP tube with round base, screw cap sold separately

Order No.	Material	Volume in ml	Length/Ø in mm	Packaging units/case
60.504.021	PP	5	75/13	2,000
60.504.022	PP	5	75/13	2,000 ☒

Screw cap for 75x13 tube, HD-PE

65.163.303	-	-	5,000
------------	---	---	-------

Polycarbonate tubes with round base, PP screw cap

- Heat resistant to 138°C, high stability
- Tubes with caps, autoclavable at 121°C (see important note on p. 219)

Volume in ml	Order No.	Material	Length/Ø in mm	Packaging units/case	Cap color	Description
12	60.9922.936	PC	99/16	1,000	White	Cap included
12	60.9922.937	PC	99/16	1,000	Yellow	Cap assembled, sterile



PP tubes with round base, HD-PE screw cap

Volume in ml	Order No.	Material	Length/Ø in mm	Packaging units/case	Cap color	Description
10	60.610	PP	92/15.3	1,000	Neutral	Cap included
10	60.610.001	PP	92/15.3	500	Neutral	Cap assembled, sterile
10	60.610.300	PP	92/15.3	1,000	Neutral	Cap assembled
10	62.610.201 with writing space and graduations	PP	92/15.3	500	Neutral	Cap assembled, sterile
10	60.506 not illustrated	PP	79/16	1,000	Neutral	Cap included
10	60.506.001 not illustrated	PP	79/16	1,000	Neutral	Cap assembled, sterile
7	60.550.034	PP	82/13	1,000	Neutral	Cap included
7	60.550.049	PP	82/13	1,000	Neutral	Cap assembled, sterile
6	60.546	PP	92/11.5	1,000	Neutral	Cap included
6	60.546.002	PP	92/11.5	1,000	Neutral	Cap assembled, sterile
4.5	60.557 not illustrated	PP	75/12	1,000	Neutral	Cap included
4.5	60.557.011 not illustrated	PP	75/12	1,000	Neutral	Cap assembled, sterile

Screw caps, polyethylene (HD-PE)

Order No.	Description	Packaging
65.1121	For screw cap tubes of 11.5 and 12 mm diameter	5,000/case
65.177.039	For screw cap tubes 82 x 13 mm	10,000/case
65.729.300	For screw cap tubes of 15.3 mm diameter	5,000/case
65.176.300	For screw cap tubes of 16 and 16.5 mm diameter	5,000/case

Polypropylene (PP) screw cap with O-ring seal

Order No.	Description	Packaging
65.714	For screw cap tubes of 16 and 16.5 mm diameter	5,000/case

* Do not screw cap on tightly when autoclaving.

PP = polypropylene, PC = transparent polycarbonate, HD-PE = high density polyethylene

Test and centrifuge tubes with round base



PP tubes with round base, HD-PE screw cap in various colors

Volume in ml	Order No.	Material	Length/Ø in mm	Packaging	Cap color	Description
13	60.541.300	PP	101/16.5	500/bag 1,000/case	neutral	Cap included
	60.541.303	PP			red	
	60.541.929	PP			yellow	
	60.541.321	PP			blue	
13	60.541.545	PP	101/16.5	100/bag 1,000/case	Neutral	Cap assembled
13	60.540.500	PP	101/16.5	500/bag 500/case	neutral	Cap assembled, sterile
	60.540.322	PP			red	
	60.540.314	PP			yellow	
	60.540.352	PP			blue	
13	60.540.108	PP	101/16.5	1/blister, 100/bag, 500/case	Neutral	Cap assembled, sterile

PP tubes with round base, PP screw cap with O-ring

- Tube with caps, autoclavable at 121°C* (see important note on p. 219)





Volume in ml	Order No.	Material	Length/Ø in mm	Packaging units/case	Cap color	Description
13	60.541.304	PP	101/16.5	1,000	neutral	Cap included
13	60.540.316	PP	101/16.5	500	neutral	Cap assembled, sterile

Color coded inserts for screw cap Ø 16.5 mm**

Order No.	Color	Packaging
65.744.999	Mixed colors (white, red, yellow, blue, green and violet)	5,000/case



Tubes with skirted round base, HD-PE screw cap

Volume in ml	Order No.	Material	Length/Ø in mm	Description	Packaging units/case	Base shape
13	60.541.385	PP	101/16.5	Neutral cap included	1,000	
13	60.540.386	PP	101/16.5	Neutral cap assembled, sterile	500	
10	60.551	PP	79/16.0	Neutral cap included	1,000	
10	60.551.001	PP	79/16.0	Neutral cap assembled, sterile	1,000	
10	62.551.201 with writing space and graduations	PP	79/16.0	Neutral cap assembled, sterile	1,000	

* Do not screw cap on tightly when autoclaving.

** Not compatible with O-ring cap.

PP = polypropylene, HD-PE = high density polyethylene

Test and centrifuge tubes with conical base



15 and 50 ml tubes, HD-PE screw cap

Volume in ml	Order No.	Material	Length/Ø in mm	Description	Packaging	Base shape
50	62.548.101	PP	114/28	Red cap included	25/bag 300/case	
50	62.547.205	PP	114/28	Red cap assembled, sterile, non-pyrogenic, non-cytotoxic	25/bag 250/case	
50	62.547.100	PP	114/28	Red cap assembled, sterile, racked, non-pyrogenic, non-cytotoxic	25/Styrofoam rack, 200/case	
50	62.547.275	PP	114/28	Neutral cap assembled, sterile, non-pyrogenic, non-cytotoxic	25/bag 250/case	
50	62.548.304	PP	114/28	Brown tube, red cap assembled	25/bag 300/case	
50	62.547.354	PP	114/28	Brown tube, red cap assembled, sterile, non-pyrogenic, non-cytotoxic	25/bag 300/case	
50	62.559.101	PP	115/28	Red cap assembled	25/bag 300/case	
50	62.559.205	PP	115/28	Red cap assembled, sterile, non-pyrogenic, non-cytotoxic	25/bag 300/case	
50	62.559.010	PP	115/28	Neutral cap assembled, sterile	25/bag 300/case	
15	62.554.101	PP	120/17	Red cap included	50/bag 500/case	
15	62.554.205	PP	120/17	Red cap assembled, sterile, non-pyrogenic, non-cytotoxic	50/bag 500/case	
15	62.554.100	PP	120/17	Red cap assembled, sterile, racked, non-pyrogenic, non-cytotoxic	50/Styrofoam rack, 500/case	
15	62.554.016	PP	120/17	Neutral cap assembled, sterile, non-pyrogenic, non-cytotoxic	50/bag 500/case	
15	62.553.001	PS	120/17	Red cap included	50/bag 500/case	
15	62.553.205	PS	120/17	Red cap assembled, sterile, non-pyrogenic, non-cytotoxic	50/bag 500/case	
15	62.553.002	PS	120/17	Red cap assembled, sterile, racked, non-pyrogenic, non-cytotoxic	50/Styrofoam rack, 500/case	
15	62.553.020	PS	120/17	Yellow cap assembled, sterile	1/blister pack 500/case	

Sample handling



Tubes with conical base, HD-PE screw cap

Volume in ml	Order No.	Material	Length/Ø in mm	Description	Packaging	Base shape
10	60.507 molded graduations	PP	75/16	Neutral cap included	500/bag 1,000/case	
10	62.9924.293 with graduations and writing space	PP	100/16	Neutral cap included	500/bag 1,000/case	
10	62.9924.294 with graduations and writing space	PP	100/16	Yellow cap assembled, sterile	100/bag 1,000/case	
30	60.544	PP	107/25	Neutral cap included	250/bag 500/case	
30	60.545	PP	107/25	Neutral cap assembled, sterile	50/bag 500/case	

PS = transparent polystyrene, PP = polypropylene, HD-PE = high density polyethylene

Test and centrifuge tubes with conical base



PP tubes with conical skirted base, HD-PE screw cap

Volume in ml	Order No.	Material	Length/Ø in mm	Description	Packaging units/case	Base shape
30	62.543	PP	107/25	Neutral cap assembled	500	
30	62.543.001	PP	107/25	Neutral cap assembled, sterile	400	
25	60.9922.241	PP	90/25	Neutral cap assembled	500	
25	63.9922.252	PP	90/25	Neutral cap assembled, with label	500	
25	60.9922.243	PP	90/25	Yellow cap assembled, sterile	500	
25	63.9922.254	PP	90/25	Yellow cap assembled, sterile, with label	500	
25	63.9922.248	PP	90/25	Yellow cap assembled, individually wrapped sterile, with label	500	



Tubes with conical skirted base, HD-PE screw cap

- Tube 76 x Ø 20 mm, highly transparent PP
- Tube 97 x Ø 16 mm, crystal-clear PS

Volume in ml	Order No.	Material	Length/Ø in mm	Description	Packaging units/case	Base shape
15	60.732	PP	76/20	Neutral cap included	500	
15	60.732.001	PP	76/20	Neutral cap assembled, sterile	500	
15	62.732.519	PP	76/20	With printed graduations, neutral cap included	500	
10	60.9921.821	PS	97/16	Neutral cap included	1,000	
10	60.9921.830	PS	97/16	Yellow cap assembled	1,000	
10	60.9921.829	PS	97/16	Yellow cap assembled, sterile	1,000	

PS = transparent polystyrene, PP = polypropylene, HD-PE = high density polyethylene

Test and centrifuge tubes with conical base



Tubes with conical skirted base, HD-PE screw cap

- Tube 66 x Ø 11.5 mm is ideal for sample storage in combination with block rack no. 93.854 (see p. 115)

Volume in ml	Order No.	Material	Length/Ø in mm	Description	Packaging units/case	Base shape
5	60.558	PP	57/15.3	Neutral cap included	1,000	
5	60.558.001	PP	57/15.3	Neutral cap assembled, sterile	1,000	
5	62.558.201 with writing space and graduations	PP	57/15.3	Neutral cap assembled, sterile	1,000	
3.5	60.549	PP	66/11.5	Neutral cap included	2,000	
3.5	60.549.001	PP	66/11.5	Neutral cap assembled, sterile	1,000	

Sample handling



Tubes with conical base, push cap

Volume in ml	Order No.	Material	Length/Ø in mm	Packaging units/case	Compatible cap no.*
12	57.462.300	PS	110/17	1,000	65.793.300 65.816
	57.462.015	PS		1,000	
	57.527.300 with graduations	PP		1,000	
12	57.462.001 sterile, not illustrated	PS	110/17	500	Cap assembled
10	62.9924.272 with graduations and writing space	PP	100/16	1,000	65.793.300 65.816 65.720
4.5	57.477	PS	75/12	2,000	65.809.300 65.719
	57.512	PP		4,000	

☒ = StackPack

* For illustration of caps see pp. 90-91.

PP = polypropylene, HD-PE = high density polyethylene, PS = transparent polystyrene

Test and centrifuge tubes with flat base

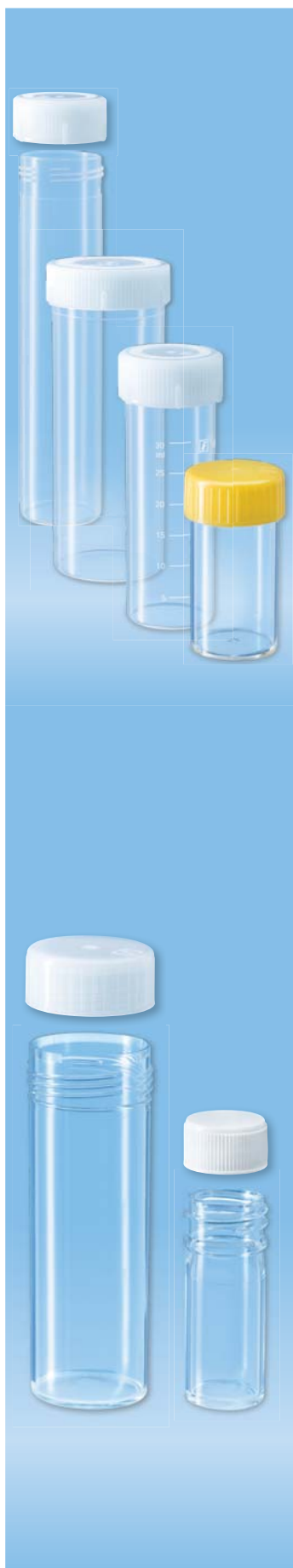

Tubes with flat base, screw cap

Volume in ml	Order No.	Material	Length/Ø in mm	Description	Packaging units/case	Base shape
120	60.597	PP	114/42	Neutral cap (PP) included	250	
120	60.597.001	PP	114/42	Neutral cap (PP) assembled, sterile	100	
60	60.596	PP	126/28.5	Neutral cap (PP) included	250	
60	60.596.001	PP	126/28.5	Neutral cap (PP) assembled, sterile	250	
40	62.555 with printed graduations up to 30 ml	PP	85/28.5	Neutral cap (PP) included	450	
40	62.555.001 with printed graduation up to 30 ml	PP	85/28.5	Neutral cap (PP) assembled, sterile	450	
25	60.9922.113	PS	54/27	Neutral cap (HD-PE) included	500	
25	60.9922.115	PS	54/27	Yellow cap (HD-PE) assembled, sterile	500	
8	60.542.300	PP	57/16.5	Neutral cap (HD-PE) included	1,000	
8	60.542.324	PP	57/16.5	Neutral cap assembled, sterile	1,000	
7	60.550	PP	82/13	Neutral cap included	1,000	
7	60.550.009	PP	82/13	Neutral cap assembled, sterile	1,000	
5	63.542.709 with label	PP	57/16.5	Neutral cap included	1,000	

PP tube with flat base, PP screw cap with O-ring

- Reliable seal, e.g. for infectious sample material
- Tube with cap*, autoclavable at 121°C* (see important note on p. 219)

Volume in ml	Order No.	Material	Length/Ø in mm	Description	Packaging units/case	Base shape
8	60.542.307	PP	57/16.5	Cap with O-ring included	1,000	

Polycarbonate tubes with flat base, PP screw cap

- Crystal clear, robust tubes
- Heat-resistant, autoclavable at 121°C* (see important note on p. 219)
- Cold-resistant, can be used down to -80°C

Volume in ml	Order No.	Material	Length/Ø in mm	Description	Packaging units/case	Base shape
30	60.9922.212	PC	80/27	Neutral cap included	500	
7	71.9923.610	PC	47/20	White cap included	1,000	

For more containers and cups with screw caps, see 'Multi-purpose containers', p. 109.

PS = transparent polystyrene, PP = polypropylene, PC = transparent polycarbonate,

HD-PE = high density polyethylene

* Do not screw cap on tightly when autoclaving.

Test and centrifuge tubes with flat base



Tubes with flat base, push caps sold separately

Volume in ml	Order No. Material	Length/Ø in mm	Packaging units/case	Compatible cap no.*
35	58.537 PP	115/23.5	500	65.790
23	58.490 PS 58.631 PP	75/23.5	1,000	65.790
21	58.489 PS	65/23.5	1,000	65.790
12	58.487 PS	40/23.5	2,000	65.790
12	58.491.300 PS 58.505.300 PP	95/16.5	1,000	65.793.300 65.816 65.720
12	62.470.300 with writing space and graduations PS	95/16.5	1,000	65.793.300 65.816 65.720
7	58.485.300 PS 58.536.300 PP	50/16	2,000	65.793.300 65.816 65.720
7	62.486.300 with writing space and graduations PS	50/16	2,000	65.793.300 65.816 65.720

Tube with flat base, push cap assembled, sterile

Volume in ml	Order No. Material	Length/Ø in mm	Packaging units/case	Cap color
7	58.485.001 PS	50/16	1,000	Neutral

Adhesive paper labels for tubes

Standard label

Tubes can be pre-labeled with standard 40 x 26 mm and 62 x 40 mm white labels with black print, illustrated here. Custom labels are available at additional cost.

Standard labels, individually on rolls

Standard labels as illustrated. Supplied in full rolls only.

Order No.	Label size	Quantity/roll
84.1556.010	40 x 26 mm	5,000
84.1027.010	62 x 40 mm	5,000

Custom label/barcode label

Labels of size 40 x 26 mm and 62 x 40 mm can be supplied with custom print upon request. Barcode labels are possible.

The minimum order for tubes with special labels is 50,000 pcs.

PS = transparent polystyrene, PP = polypropylene

* For illustration of caps see pp. 90-91.



Push caps

Push caps for test and centrifuge tubes



For tube size
95 x 24.8 mm

Order No.	Color	Material
65.791	Neutral	LD-PE

2,000/case



For tube sizes
115 x 23.5 mm 87 x 23.5 mm
75 x 23.5 mm 65 x 23.5 mm
40 x 23.5 mm

Order No.	Color	Material
65.790	Neutral	LD-PE

2,000/case



For tube size
100 x 21.5 mm

Order No.	Color	Material
65.529	Neutral	LD-PE

5,000/case

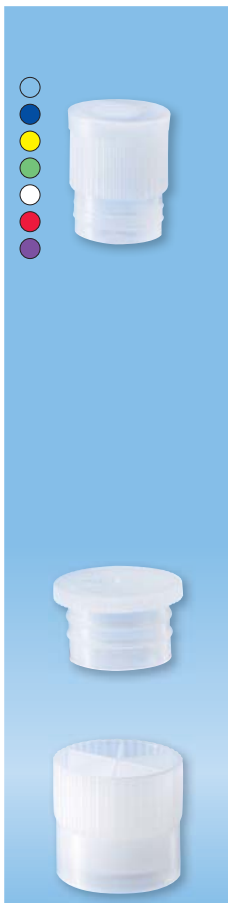

For tube sizes
130 x 17.0 mm 95 x 16.8 mm
119 x 15.5 mm 95 x 16.5 mm
110 x 17.0 mm 82 x 16.8 mm
105 x 16.8 mm 50 x 16.0 mm
100 x 16.0 mm 67 x 16.8 mm

Order No.	Color	Material
65.793.300	Neutral	LD-PE
65.793.313	Blue	LD-PE
65.793.314	Yellow	LD-PE
65.793.315	Green	LD-PE
65.793.317	White	LD-PE
65.793.318	Red	LD-PE
65.793.320	Violet	LD-PE

5,000/case

Order No.	Color	Material
65.816	Neutral	LD-PE

10,000/case

Skirted push cap

Order No.	Color	Material
65.720	Neutral	HD-PE

2,000/case



For tube sizes
100 x 15.7 mm
75 x 15.7 mm
65 x 15.7 mm

Order No.	Color	Material
65.803.300	Neutral	LD-PE
65.803.302	Green	LD-PE
65.803.305	Violet	LD-PE
65.803.312	Red	LD-PE
65.803.332	Yellow	LD-PE

5,000/case

Order No.	Color	Material
65.802	Neutral	LD-PE

10,000/case

Skirted push cap

Order No.	Color	Material
65.727	Neutral	HD-PE

5,000/case



For tube size
84 x 14.5 mm

Order No.	Color	Material
65.804.300	Neutral	LD-PE

5,000/case



For tube size
50 x 14 mm

Order No.	Color	Material
65.804.001	Neutral	LD-PE

10,000/case

HD-PE = high density polyethylene
LD-PE = low density polyethylene

Push caps for test and centrifuge tubes



For tube sizes
100 x 13 mm
85 x 13 mm
75 x 13 mm

Order No.	Color	Material
65.806.300	Neutral	LD-PE
65.806.306	Blue	LD-PE
65.806.307	Yellow	LD-PE
65.806.308	Green	LD-PE
65.806.310	Red	LD-PE
65.806.311	Violet	LD-PE
65.806.312	White	LD-PE

10,000/case

Order No.	Color	Material
65.818	Neutral	LD-PE

10,000/case

Skirted push cap

Order No.	Color	Material
65.724	Neutral	LD-PE

10,000/case



For tube sizes
75 x 12.0 mm
55 x 12.0 mm

Order No.	Color	Material
65.809.300	Neutral	LD-PE
65.809.303	Violet	LD-PE
65.809.306	Red	LD-PE
65.809.304	Blue	LD-PE
65.809.301	Yellow	LD-PE
65.809.302	Green	LD-PE
65.809.307	Orange	LD-PE
65.809.305	White	LD-PE

10,000/case

Skirted push cap

Order No.	Color	Material
65.719	Neutral	LD-PE

5,000/case

Two-position ventilation caps

For tube size
75 x 12 mm

Order No.	Color	Material
65.722	Neutral	LD-PE

5,000/case



For tube size
100 x 16 mm PP

Order No.	Color	Material
65.725	Neutral	LD-PE

5,000/case



For tube size
75 x 10 mm

Order No.	Color	Material
65.782	Neutral	LD-PE

10,000/case



Anti-evaporation cap for
S-Monovette®
of 15 mm diameter

Order No.	Color	Material
65.648	Neutral	HD-PE

5,000/case



Archiving caps for tubes
of 13–16 mm diameter

Order No.	Color	Material
65.647	Pale blue	PP
65.647.020	Pale blue with filter	PP

5,000/case



Universal cap for S-Monovette®
of 13 mm diameter and for tubes
of 12–17 mm diameter

Order No.	Color	Material
65.1379	Neutral	LD-PE
65.1379.002	Red	LD-PE
65.1379.004	Yellow	LD-PE
65.1379.005	Green	LD-PE
65.1379.006	Blue	LD-PE
65.1379.007	Violet	LD-PE
65.1379.008	Gray	LD-PE
65.1379.010	Black	LD-PE

10,000/case

HD-PE = high density polyethylene

LD-PE = low density polyethylene

PP = polypropylene

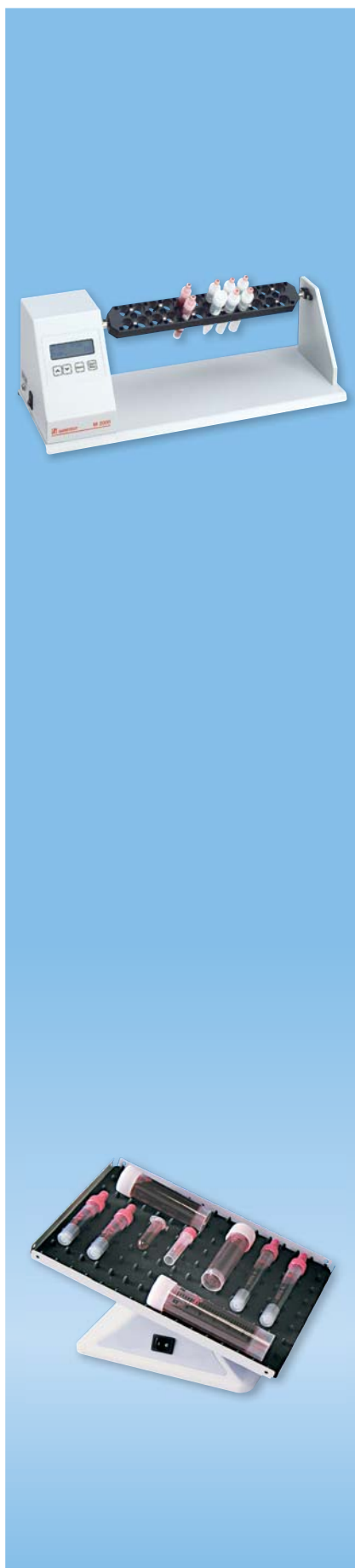

Sarmix® M 2000

- Rotating mixer with variable speed and shaking functions
- Ideal for hematology and research applications
- Mixing programs for many different tasks
- Exchangeable rotors for many different tube sizes

Order No.	Description
90.180.600	Sarmix® M 2000, inc. 12 V DC power pack Basic appliance without rotor, with EU/UK/US plug
92.180.610	Plate rotor for 23 tubes Ø 8–12 mm
92.180.611	Plate rotor for 2 tubes up to Ø 35 mm and 6 tubes up to Ø 20 mm and 6 tubes up to Ø 12.5 mm
92.180.612	Block rotor for 40 tubes up to Ø 11.5 mm
92.180.613	Block rotor for 24 tubes up to Ø 15 mm
92.180.614	Block rotor for 7 tubes up to Ø 28 mm (50 ml tubes)
92.180.615	Block rotor for 40 tubes up to Ø 8.5 mm (S-Sedivette®, 1.5 ml and 2.0 ml reaction tubes and screw cap micro tubes)
92.180.616	Block rotor for 14 tubes up to Ø 28 mm (50 ml tubes)
92.180.617	Block rotor for 24 tubes up to Ø 17 mm (15 ml tubes)
92.180.618	Block rotor for 36 tubes up to Ø 15 mm
92.180.619	Block rotor for 8 tubes up to Ø 22 mm

Sarmix® GM 1

- Nutating mixer with 3-dimensional mixing motion
- Accommodates all tube sizes: the dimpled rubber mat holds tubes securely

Order No.	Description
90.181.401	Sarmix® GM 1, 115 V, US plug
90.181.402	Sarmix® GM 1, 230 V, UK plug
90.181.403	Sarmix® GM 1, 230 V, Swiss plug
92.181.410	Replacement dimpled rubber mat

Designed to meet the highest quality standards

Over 40 years ago, SARSTEDT established a new laboratory standard: the secure and reliable screw cap micro tube. SARSTEDT's screw cap micro tubes are now used worldwide and are a crucial part of daily research and diagnostic work for storage, transport, centrifugation, and more.

The SARSTEDT screw cap micro tube range provides a multitude of tube and cap options with volumes from 0.5 to 2.0 ml.



Sample handling

Also available without circumference knurls for larger labeling space.



Transportation and storage containers for high-grade synthesized oligonucleotides, enzymes, buffers, etc.

Range of color-coding options including colored caps and inserts



Convenient single-handed opening and closing with SARSTEDT gripper racks

Guaranteed reliability and reproducibility

Cleanroom conditions, skilled personnel wearing protective clothing, and automated production processes are the prerequisites for the certified SARSTEDT 'PCR Performance Tested' and 'Biosphere® plus' quality standards.

Since 1995, we have provided our customers with product purity certifications tailored to their applications to ensure maximum reproducibility in their analyses. Our certification standards are continuously adjusted so that we can offer the user the required level of purity in their routine work at all times.



PCR performance tested quality · The SARSTEDT quality and purity standard

The 'PCR Performance Tested' certification is tailored to the demands and requirements of work with nucleic acids (e.g. qPCR, PCR, purification and storage). This quality grade allows customers to use SARSTEDT disposables with confidence, directly in nucleic acid analysis.

PCR Performance Tested products meet the following purity criteria, which are certified by an independent laboratory:

- ✓ DNA-free
- ✓ DNase- and RNase-free
- ✓ PCR inhibitor-free

We guarantee that the following limits are not exceeded:

**Human DNA <0.5 pg/μl · Bacterial DNA <0.02 pg/μl · DNase <1x10⁻⁵ U/μl
RNase <1x10⁻⁹ Kunitz units/μl**

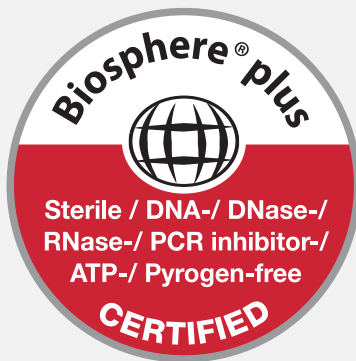

Biosphere® plus quality · Highest purity

Scientific analysis methods have become continuously refined to the point where even individual molecules can now be identified. As sensitivity increases, disposables are required to meet significantly more exacting requirements so that users can be certain that even the smallest contamination will be reliably excluded.

The Biosphere® plus quality constitutes a purity standard that enables the utmost protection against any possible contamination.

In addition to our high purity production conditions, all Biosphere® plus certified products undergo a validated decontamination process. The limits are thus significantly lower than those of the 'PCR Performance Tested' quality. Biosphere® plus items are also free from ATP and pyrogens/endotoxins, and are sterile in accordance with ISO 11135.

Biosphere® plus items fulfil the following purity criteria, which are certified by an independent laboratory:

- ✓ Sterile
- ✓ DNA-free
- ✓ DNase- and RNase-free
- ✓ PCR inhibitor-free
- ✓ ATP-free
- ✓ Pyrogen-free/endotoxin-free

We guarantee that the following limits are not exceeded:

**Human DNA <5.0 fg/μl · Bacterial DNA <0.2 fg/μl · DNase <5x10⁻⁷ U/μl
RNase <5x10⁻¹¹ Kunitz-units/μl · ATP <1x10⁻¹² mmol/μl · pyrogens <0.002 EU/ml
Sterility validated according to ISO 11135**

Certified screw cap micro tubes

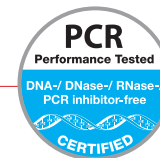
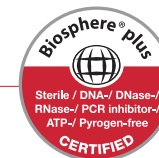

Uncompromising quality and purity

- Tubes with screw caps that are free from DNA, DNase and RNase are ideal for storage of high-grade synthesized oligonucleotides, enzymes, buffers etc.
- Sterile Biosphere® plus products prevent false positive results in DNA/Human DNA analytics, in forensic and diagnostic investigations

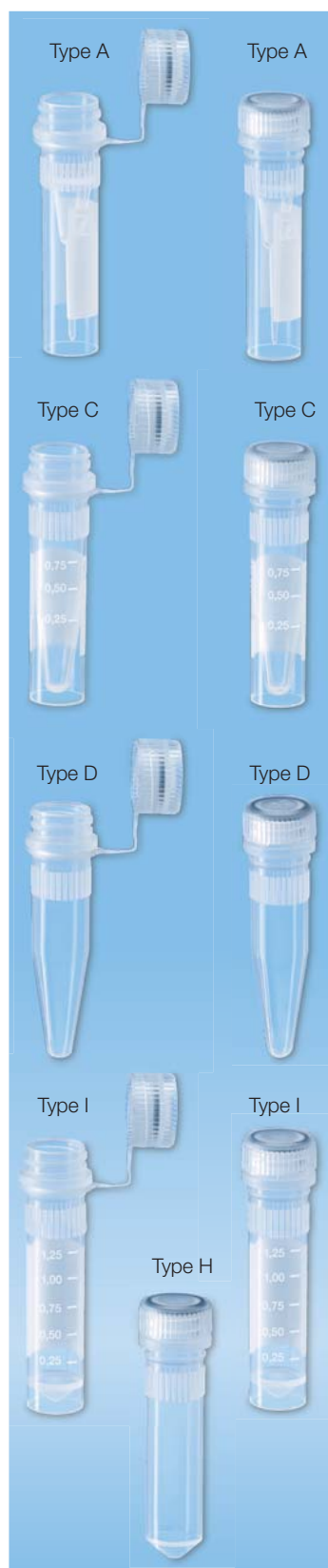

Screw cap micro tubes 0.5 ml, type A with skirted base, neutral cap

Order No.	Description		Packaging
72.730.217	With loop screw cap, unscrewed, printed, sterile		25/bag 250/inner box 500/case
72.730.416	With loop screw cap assembled, printed		100/bag 500/inner box 1,000/case
72.730.406	With screw cap assembled, printed		100/bag 500/inner box 1,000/case

Screw cap micro tubes 1.5 ml, type C with skirted base, neutral cap

Order No.	Description		Packaging
72.703.217	With loop screw cap, unscrewed, printed, sterile		25/bag 250/inner box 500/case
72.703.416	With loop screw cap assembled, printed		100/bag 500/inner box 1,000/case
72.703.406	With screw cap assembled, printed		100/bag 500/inner box 1,000/case

Screw cap micro tubes 1.5 ml, type D, conical base, neutral cap

Order No.	Description		Packaging
72.692.210*	With loop screw cap, unscrewed, no print, sterile		25/bag 250/inner box 500/case
72.692.415*	With loop screw cap assembled, no print		100/bag 500/inner box 1,000/case
72.692.405*	With screw cap assembled, no print		100/bag 500/inner box 1,000/case

Screw cap micro tubes 2.0 ml, type I with skirted base, neutral cap

Order No.	Description		Packaging
72.694.217	With loop screw cap, unscrewed, printed, sterile		25/bag 250/inner box 500/case
72.694.416	With loop screw cap assembled, printed		100/bag 500/inner box 1,000/case
72.694.406	With screw cap assembled, printed		100/bag 500/inner box 1,000/case

Screw cap micro tubes 2.0 ml, type H, conical base, neutral cap

Order No.	Description		Packaging
72.693.465	With screw cap assembled, no print		100/bag 500/inner box, 1,000/case

* Available unprinted only, for technical reasons.

Sample handling

Low-binding screw cap micro tubes

Low-binding screw cap micro tubes – minimal sample loss

As the trend towards decreasing sample volumes continues, it is increasingly important to minimize potential interaction between the analyte and the tube. Our low protein and low DNA binding screw cap and push cap micro tubes are specifically designed to meet the requirements of protein and DNA analytics while maximizing recovery rates. With expensive and valuable reagents in particular, minimizing sample loss provides cost savings and ensures accurate analysis results and safe long-term storage.

SARSTEDT low-binding tubes are produced from special plastics that eliminate the need for repellent coatings like silicone, which could affect analysis results.

Product benefits of low-binding screw cap micro tubes:

- Three sizes – 0.5 ml, 1.5 ml and 2.0 ml
- Robust polypropylene – can be centrifuged up to 20,000 x g*
- Stable skirted base – stands securely on the lab bench without a rack
- Circumference knurls – caps can be screwed on single-handedly in corresponding gripper racks
- Certified PCR performance tested quality – DNA-free, DNase/RNase-free and free from PCR inhibitors
- Convenient small pack sizes – 100 pieces in a zip seal bag to reduce risk of contamination

*Filled with demineralized water (low surface tension) up to nominal volume, at 20°C for 90 minutes in a fixed-angle rotor.



Low protein-binding – minimal protein loss

Low protein-binding screw cap micro tubes are ideal for storing, bottling and analyzing antibodies, enzymes and other valuable substances, both in proteomics and in many other routine applications. The minimal protein binding to the tube wall allows for maximum recovery, improved analyses and clearer results.

Low DNA-binding – minimal DNA loss

Low DNA-binding screw cap micro tubes are ideal for all applications involving DNA. They can be used for the storage of plasmids, oligonucleotides, and cell extracts and allow maximum DNA recovery even after a long storage period and with very small volumes.

Order No.	Volume	Description	PCR Performance Tested	Packaging
72.730.600	0.5 ml	Low protein-binding		100/bag 500/inner box 1,000/case
72.730.700		Low DNA-binding		
72.703.600	1.5 ml	Low protein-binding		
72.703.700		Low DNA-binding		
72.694.600	2.0 ml	Low protein-binding		
72.694.700		Low DNA-binding		



Screw cap micro tube for restricting volumes

- Ideal for small volumes of concentrated or expensive reagents and samples
- Volume limiter cap and special 0.5 ml screw cap micro tube reduces tube volume to 100 µl
- Reduces evaporation and prevents sample hold-up at top of tube

Order No.	Description	Packaging bag/case
72.733.201	Screw cap micro tube for restricting volumes	500/5,000
65.710	Volume limiter screw cap	500/5,000

Screw cap micro tubes with standard cap

For transportation, storage and sample processing in the laboratory

- Secure screw cap with O-ring seal
- PP tube and cap, autoclavable at 121°C (see important note on p. 219)
- Circumference knurls allow caps to be screwed onto micro tubes single-handedly in SARSTEDT gripper racks (for racks, see p. 99)

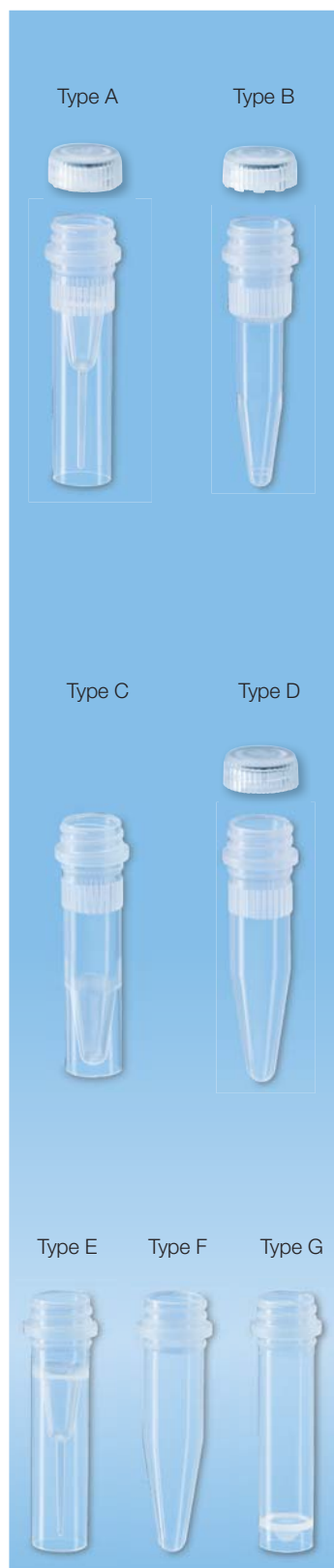

Screw cap micro tubes 0.5 ml, type A with skirted base, neutral cap

Order No.	Description	Packaging units/case
72.730	Cap included	5,000
72.730.005	Cap assembled, sterile	1,000
72.730.007	With writing space, cap included	5,000
72.730.006	With writing space, cap assembled, sterile	1,000
72.730.003	Without cap	5,000
72.730.009	With writing space, without cap	5,000
72.730.004	Amber tube, without cap	5,000

Screw cap micro tubes 0.5 ml, type B with conical base, neutral cap

Order No.	Description	Packaging units/case
72.733.001	Cap included	5,000
72.733.010	Without cap	5,000

Screw cap micro tubes 1.5 ml, type C with skirted base

Order No.	Description	Packaging units/case
72.703	Without cap	5,000
72.703.004	Amber tube, without cap	5,000

Screw cap micro tubes 1.5 ml, type D with conical base, neutral cap

Order No.	Description	Packaging units/case
72.692	Cap included	5,000
72.692.005	Cap assembled, sterile	1,000
72.607	Without cap	5,000

Screw cap micro tubes type E–G without knurls, neutral cap

- Provides a larger area for labeling

Order No.	Description	Tube type	Packaging units/case
72.785	0.5 ml, with skirted base, without cap	E	5,000
72.785.005	0.5 ml, with skirted base, cap assembled, sterile	E	1,000
72.687	1.5 ml, with conical base, without cap	F	5,000
72.664	2.0 ml, with skirted base, without cap	G	5,000

For storage boxes and racks, see pp. 99, 110-117.

Screw cap micro tubes with standard cap

For transportation, storage and sample processing in the laboratory

- Secure screw cap with O-ring seal
- PP tube and cap, autoclavable at 121°C (see important note on p. 219)
- Circumference knurls allow caps to be screwed onto micro tubes single-handedly in SARSTEDT gripper racks



Screw cap micro tubes 2.0 ml, type H and I, neutral cap

Order No.	Description	Tube type	Packaging units/case
72.693	Conical base, cap included	H	5,000
72.693.005	Conical base, cap assembled, sterile	H	1,000
72.608	Conical base, without cap	H	5,000
72.694	Skirted base, cap included	I	5,000
72.694.005	Skirted base, cap assembled, sterile	I	1,000
72.694.007	Skirted base, with writing space and graduations*, cap included	I	5,000
72.694.006	Skirted base, with writing space and graduations*, cap assembled, sterile	I	1,000
72.694.996	Skirted base, with writing space and graduations*, mix of 10 different cap colors, cap assembled, sterile	I	1,000
72.609	Skirted base, without cap	I	5,000
72.609.001	Skirted base, with writing space and graduations*, without cap	I	5,000
72.609.003	Skirted base, amber, without cap	I	5,000

Screw cap micro tubes, sterile, in special double-bag packaging, without cap

Order No.	Description	Tube type	Packaging units/case
72.730.711	0.5 ml, with skirted base	A	500/double bag, 2,500/case
72.607.772	1.5 ml, with conical base	D	
72.687.772	1.5 ml, with conical base, without knurls	F	
72.664.711	2.0 ml, with skirted base, without knurls	G	
72.609.711	2.0 ml, with skirted base	I	

Colored screw caps for micro tubes types A-I, 10,000/case

Order No.	Color	Order No.	Color
65.716	Neutral	65.716.006	Orange
65.716.001	Blue	65.716.007	Black
65.716.002	Yellow	65.716.008	Violet
65.716.003	Red	65.716.022	White
65.716.004	Pink	65.716.009	Brown
65.716.005	Green	65.716.999	mix of 10 colors

Colored screw caps, sterile, in special double-bag packaging

Packed 500 pieces/double bag, 5,000/case

Order No.	Color	Order No.	Color
65.716.725	Neutral	65.716.720	Yellow
65.716.721	Red	65.716.723	Blue
65.716.726	Green	65.716.727	Orange
65.716.728	Black	65.716.729	Brown
65.716.755	Violet	65.716.757	White

Membrane screw cap for micro tubes

Screw cap with pierceable membrane, ideal for automated filling of screw cap micro tubes or direct analyzer sampling. The screw cap can be combined with all micro tubes of types A to I.

Order No.	Description	Packaging
65.3716	Screw cap with pierceable membrane	2,000 pcs./case

*For technical reasons, graduations can only be printed up to 1.25 ml.

Screw cap micro tubes with attached loop cap

For transportation, storage and sample processing in the laboratory

- Attached loop screw cap with O-ring seal prevents mix-ups
- PP tube and cap, autoclavable at 121°C (see important note on p. 219)
- Circumference knurls allow caps to be screwed onto micro tubes single-handedly in SARSTEDT gripper racks



Screw cap micro tubes 0.5 ml, type A with skirted base, neutral loop cap attached

Order No.	Description	Packaging units/case
72.730.100	Cap unscrewed	5,000
72.730.107	With writing space, cap unscrewed	5,000
72.730.105	Cap assembled, sterile	1,000
72.730.106	With writing space, cap assembled, sterile	1,000

Screw cap micro tubes 1.5 ml, type D with conical base, neutral loop cap attached

Order No.	Description	Packaging units/case
72.692.100	Cap unscrewed	5,000
72.692.105	Cap assembled, sterile	1,000

Screw cap micro tubes 2.0 ml, type H with conical base, neutral loop cap attached

Order No.	Description	Packaging units/case
72.693.100	Cap unscrewed	5,000
72.693.105	Cap assembled, sterile	1,000

Screw cap micro tubes 2.0 ml, type I with skirted base, neutral loop cap attached

Order No.	Description	Packaging units/case
72.694.100	Cap unscrewed	5,000
72.694.107	With writing space and graduations*, cap unscrewed	5,000
72.694.105	Cap assembled, sterile	1,000
72.694.106	With writing space and graduations*, cap assembled, sterile	1,000

Screw cap with retaining loop, separate, neutral

Order No.: 65.712 packed 500/bag, 5,000/case

Color-coded inserts for loop screw caps

Packed 500/bag, 5,000/case

Order No.	Color	Order No.	Color
65.713	Neutral	65.713.006	Blue
65.713.002	Red	65.713.007	Violet
65.713.004	Yellow	65.713.009	White
65.713.005	Green	65.713.010	Black

Gripper racks for screw cap micro tubes

Notched apertures enable single-handed cap assembly of micro tubes with circumference knurls

Order No.	Number of wells	Rack dimensions
93.894	3x6 (for 18 tubes)	40 x 137 x 70 mm
93.848.100	2x10 (for 20 tubes)	40 x 257 x 62 mm
93.1428	4x12 (for 48 tubes)	40 x 257 x 90 mm

*For technical reasons, graduations can only be printed up to 1.25 ml.

Low binding micro tubes

Micro tubes must meet a range of requirements: they must be resistant to mechanical and thermal strain; interaction with analytes must be minimized; and biological purity is of vital importance. In addition to standard micro tubes, our range includes SafeSeal options for use under thermal stress and low binding tubes minimizing protein or DNA binding to the plastic material. Certified purity is guaranteed by our quality standards PCR Performance Tested and Biosphere® plus.

Low binding micro tubes

As the trend towards decreasing volumes continues, it is increasingly important to minimize potential interaction between the analytes and the reaction tubes. SARSTEDT's low binding tubes are specially designed for the requirements of protein/DNA analytics to ensure maximum protein/DNA recovery rates. Minimizing sample loss, especially for the low protein/DNA concentrations often present, is essential in order to make additional analyses possible.

- Minimal protein/DNA-binding = maximum recovery rates = minimal protein/DNA loss
- Low DNA-binding tubes can be centrifuged up to 30,000 x g* (2 ml up to 25,000 x g*)
- Low protein-binding tubes can be centrifuged up to 20,000 x g*

*Filled with demineralized water (low surface tension) up to nominal volume, at 20°C for 90 minutes in a fixed-angle rotor

Low protein binding – Comparison of mean BSA loss

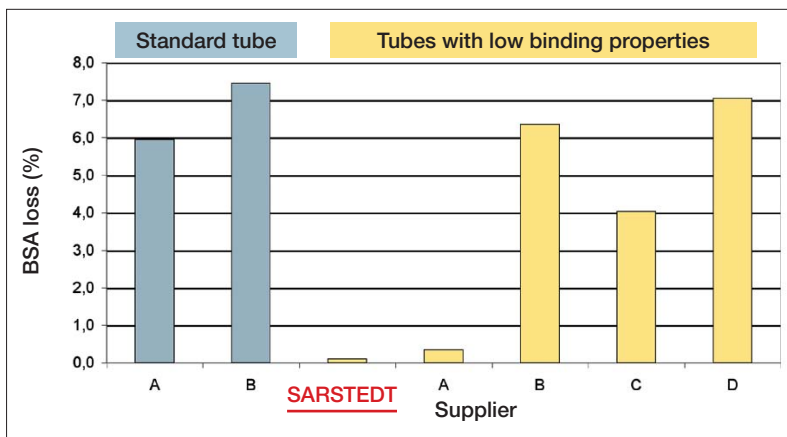

Experiment method:

Ten test tubes each from a range of suppliers were filled with an aqueous solution of BSA at a concentration of 10 µg/ml in water and stored at 4°C. After 24 hours incubation, the BSA solution was removed and the concentration was determined using a Bradford assay (Zor, T. and Selinger, 1996, Anal. Biochem. 236, pp. 302–308).

Loss percentages were calculated based on the mean value across the 10 tubes tested.

Low DNA binding – Comparison of DNA loss

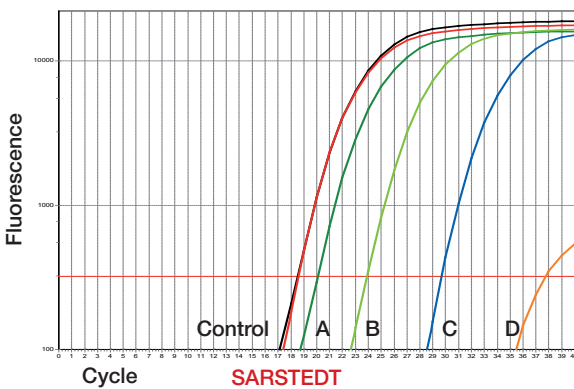

Experiment method:

Ten test tubes each from a range of suppliers were filled with 100 µl of a plasmid DNA solution (concentration: 10⁴/µl) and shaken at 37°C. After 3 hours incubation, the DNA content was determined using real time PCR.

One of the ten test series is shown in this diagram as an example.

- Control
- SARSTEDT
- Supplier A
- Supplier B
- Supplier C
- Supplier D



Order No.	Volume	Description	Packaging
72.704.600	0.5 ml	Low protein-binding	50/bag 300/inner box 1,200/case
72.704.700		Low DNA-binding	
72.706.600	1.5 ml	Low protein-binding	50/bag 200/inner box 800/case
72.706.700		Low DNA-binding	
72.695.600	2.0 ml	Low protein-binding	50/bag 200/inner box 800/case
72.695.700		Low DNA-binding	

SafeSeal micro tubes

SafeSeal micro tubes

- Retaining cam ensures cap is firmly closed, even under thermal load
- Wide hinge for easy and precise closure
- Large writing space on cap
- Can be centrifuged up to 30,000 x g* (2.0 ml up to 25,000 x g*)
- Three purity grades available



SafeSeal micro tube, 0.5 ml, PP, with wide hinge

Order No.	Length/Ø in mm	Color	Packaging	units/case
72.704	30/7.8	Neutral	500/bag	2,000
72.704.001	30/7.8	Brown	500/bag	2,000
72.704.002	30/7.8	Red	500/bag	2,000
72.704.004	30/7.8	Yellow	500/bag	2,000
72.704.005	30/7.8	Green	500/bag	2,000
72.704.006	30/7.8	Blue	500/bag	2,000

• PCR Performance Tested

72.704.400	30/7.8	Neutral	250/bag	2,000
------------	--------	---------	---------	-------

• Biosphere® plus (sterile) in small pack sizes

72.704.200	30/7.8	Neutral	50/bag	500
------------	--------	---------	--------	-----



SafeSeal micro tube, 1.5 ml, PP, with wide hinge

Order No.	Length/Ø in mm	Color	Packaging	units/case
72.706	39/10.8	Neutral	250/bag	2,000
72.706.001	39/10.8	Brown	250/bag	2,000
72.706.002	39/10.8	Red	250/bag	2,000
72.706.004	39/10.8	Yellow	250/bag	2,000
72.706.005	39/10.8	Green	250/bag	2,000
72.706.006	39/10.8	Blue	250/bag	2,000

• PCR Performance Tested

72.706.400	39/10.8	Neutral	250/bag	2,000
------------	---------	---------	---------	-------

• Biosphere® plus (sterile) in small pack sizes

72.706.200	39/10.8	Neutral	50/bag	500
72.706.201	39/10.8	Neutral	Individually wrapped	120



SafeSeal micro tube, 2.0 ml, PP, with wide hinge

Order No.	Length/Ø in mm	Color	Packaging	units/case
72.695.500	40/10.8	Neutral	250/bag	2,000
72.695.001	40/10.8	Brown	250/bag	2,000
72.695.002	40/10.8	Red	250/bag	2,000
72.695.004	40/10.8	Yellow	250/bag	2,000
72.695.005	40/10.8	Green	250/bag	2,000
72.695.006	40/10.8	Blue	250/bag	2,000
72.695.007	40/10.8	Purple	250/bag	2,000

• PCR Performance Tested

72.695.400	40/10.8	Neutral	250/bag	2,000
------------	---------	---------	---------	-------

• Biosphere® plus (sterile) in small pack sizes

72.695.200	40/10.8	Neutral	50/bag	500
72.695.201	40/10.8	Neutral	Individually wrapped	120





*Filled with demineralized water (low surface tension) up to nominal volume, at 20°C for 90 minutes in a fixed-angle rotor.

For storage boxes and racks for micro tubes, see pp. 110-117.



Micro tube, 0.5 ml, PP, with attached PP cap

- With frosted writing space

Order No.	Length/Ø in mm	Color	Packaging	units/case
72.699	30/7.8	Neutral	1,000/bag	5,000
72.699.001	30/7.8		500/bag	5,000
72.699.002	30/7.8		500/bag	5,000
72.699.003	30/7.8		500/bag	5,000
72.699.004	30/7.8		500/bag	5,000
72.699.005	30/7.8		500/bag	5,000







Micro tube, 0.5 ml, PP, with attached PP cap, ventilation hole in cap

Order No.	Length/Ø in mm	Color	Packaging	units/case
72.698	30/7.8	Neutral	1,000/bag	5,000



Micro tube, 1.5 ml, PP, with attached PP cap

- With graduations and frosted writing space

Order No.	Length/Ø in mm	Color	Packaging	units/case
72.690.301	39/10.8	Neutral	500/bag	5,000
72.690.304	39/10.8		500/bag	5,000
72.690.307	39/10.8		500/bag	5,000
72.690.375	39/10.8		500/bag	5,000
72.690.376	39/10.8		500/bag	5,000
72.690.377	39/10.8		500/bag	5,000
72.690.378	39/10.8		500/bag	5,000

Micro tube, 1.5 ml, PP, with attached PP 'EASY CAP'







- Easy cap closure fits loosely for applications without thermal load

Order No.	Length/Ø in mm	Color	Packaging	units/case
72.690.550	39/10.8	Neutral	500/bag	5,000



Micro tube, 2.0 ml, PP, with attached PP cap

- With graduations and frosted writing space







Order No.	Length/Ø in mm	Color	Packaging	units/case
72.691	40/10.8	Neutral	500/bag	5,000
72.691.001	40/10.8		500/bag	5,000
72.691.002	40/10.8		500/bag	5,000
72.691.004	40/10.8		500/bag	5,000
72.691.005	40/10.8		500/bag	5,000
72.691.006	40/10.8		500/bag	5,000
72.691.007	40/10.8		500/bag	5,000

For storage boxes and racks for micro tubes, see pp. 110-117.

Micro tubes









Micro tube, 1.5 ml, PP, with attached LD-PE loop push cap

Order No.	Length/Ø in mm	Cap color	Packaging	units/case
72.688	39/10.8	Neutral 	500/bag	5,000
72.688.001	39/10.8	Blue 	500/bag	5,000
72.688.002	39/10.8	Green 	500/bag	5,000
72.688.003	39/10.8	Red 	500/bag	5,000
72.688.004	39/10.8	Yellow 	500/bag	5,000
72.688.005	39/10.8	Violet 	500/bag	5,000



Micro tube, 2.0 ml, PP, with attached LD-PE loop push cap

Order No.	Length/Ø in mm	Cap color	Packaging	units/case
72.689	39/10.8	Neutral 	500/bag	5,000
72.689.001	39/10.8	Blue 	500/bag	5,000
72.689.002	39/10.8	Green 	500/bag	5,000
72.689.003	39/10.8	Red 	500/bag	5,000
72.689.004	39/10.8	Yellow 	500/bag	5,000
72.689.006	39/10.8	Violet 	500/bag	5,000



PP micro tubes without caps

Order No.	Length/Ø in mm	Base shape	Volume	Packaging bag/ case
72.698.200	30/7.8	Conical	0.5 ml	500/5,000
72.696	39/10.8	Conical	1.5 ml	500/10,000
72.708	39/10.8	Conical	2.0 ml	500/5,000
72.709	39/10.8	Conical/skirted base	2.0 ml	500/5,000

LD-PE caps for 1.5 and 2.0 ml micro tubes

Flat push cap	Tall push cap	Push cap with retaining loop
		
Order No.: 65.697 neutral	Order No.: 65.723 neutral	Order No.: 65.109 neutral
Packaging: 1,000/bag • 10,000/case		

For storage boxes and racks for micro tubes, see pp. 110-117.
 PP = polypropylene, LD-PE = low density polyethylene

CryoPure – certified quality



CryoPure tubes are subjected to extensive testing to ensure that potential contamination which could harm cell materials and cellular components during 'vital preservation' are not present.

Upon successfully meeting stringent testing criteria, CryoPure tubes are certified as follows (see also p. 154):

- Sterile
- Pyrogen-free/endotoxin-free
- Non-cytotoxic
- Non-mutagenic
- IVD CE

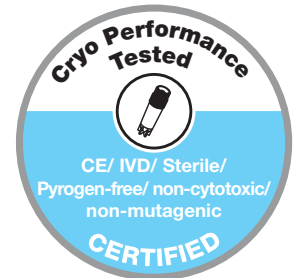

Efficient and reliable

- SARSTEDT CryoPure tubes are made of high quality materials (USP class VI) and are available in volumes of 1.2 to 5 ml.
- Tubes with external thread minimize the risk of contamination.
- For more compact storage (10 x 10 grid), a 2 ml CryoPure tube with internal thread and silicone seal is available.
- The QuickSeal design enables ergonomic and secure opening and closing of both types of cap with a single turn.
- 6 cap colors and 6 cap insert colors provide up to 36 different color-coding possibilities.



CryoRack 40 - polypropylene work rack

- 4 rows of 10 wells for 40 tubes
 - Single-handed tube opening/closing due to interlocking base
 - Alphanumeric coding for easy sample identification
 - Anti-slip rubber feet
 - Autoclavable, 121 °C, 20 min.
- CryoRack 40**
Order No. 93.856.040 (1/bag, 10/case)





Cryo boxes for deep-freeze storage

- High-grade polycarbonate storage boxes for deep-freeze temperatures down to -196 °C
- Numerical coding at each aperture enables quick sample identification







	Compatible cryo tubes		1.2–2.0 ml		3.5–5.0 ml	
	Format		5 x 5	9 x 9	10 x 10	9 x 9
	Storage capacity		25	81	100	81
	Box size (W x D x H) in mm		75 x 75 x 52	132 x 132 x 53	132 x 132 x 53	132 x 132 x 95
Ideal for tubes with		Internal and external thread		Internal thread	Internal and external thread	
	Packaging	Color	Order No.			
	5/bag 20/case	Red	93.872.225	93.873.281	93.874.210	93.875.281
		Yellow	93.872.425	93.873.481	93.874.410	93.875.481
		Blue	93.872.625	93.873.681	93.874.610	93.875.681









CryoPure 1.2 ml tubes with external thread

Order No.	Screw cap	Nominal volume	Packaging
72.377	White 	1.0 ml	50/bag 500/inner box 2,000/case
72.377.002	Red 	1.0 ml	
72.377.004	Yellow 	1.0 ml	
72.377.005	Green 	1.0 ml	
72.377.007	Violet 	1.0 ml	
72.377.992	Color mix 	1.0 ml	







CryoPure 2.0 ml tubes with external thread

Order No.	Screw cap	Nominal volume	Packaging
72.379	White 	1.8 ml	50/bag 500/inner box 2,000/case
72.379.002	Red 	1.8 ml	
72.379.004	Yellow 	1.8 ml	
72.379.005	Green 	1.8 ml	
72.379.006	Blue 	1.8 ml	
72.379.007	Violet 	1.8 ml	
72.379.992	Color mix 	1.8 ml	







CryoPure 5.0 ml tubes with external thread

Order No.	Screw cap	Nominal volume	Packaging
72.383	White 	4.5 ml	25/bag 250/inner box 1,000/case
72.383.002	Red 	4.5 ml	
72.383.004	Yellow 	4.5 ml	
72.383.005	Green 	4.5 ml	
72.383.007	Violet 	4.5 ml	
72.383.992	Color mix 	4.5 ml	

CryoPure 2.0 ml tubes with internal thread and silicone O-ring

Order No.	Screw cap	Nominal volume	Packaging
72.380	White 	1.6 ml	50/bag 500/inner box 2,000/case
72.380.002	Red 	1.6 ml	
72.380.004	Yellow 	1.6 ml	
72.380.005	Green 	1.6 ml	
72.380.006	Blue 	1.6 ml	
72.380.007	Violet 	1.6 ml	
72.380.992	Color mix 	1.6 ml	

Color-coded cap inserts for CryoPure tubes

Order No.	Color	Packaging
65.386	White 	100/bag · 3,000/case
65.386.002	Red 	
65.386.004	Yellow 	
65.386.005	Green 	
65.386.006	Blue 	
65.386.007	Violet 	100/bag · 5 colors · 2,500/case
65.386.992	Color mix 	





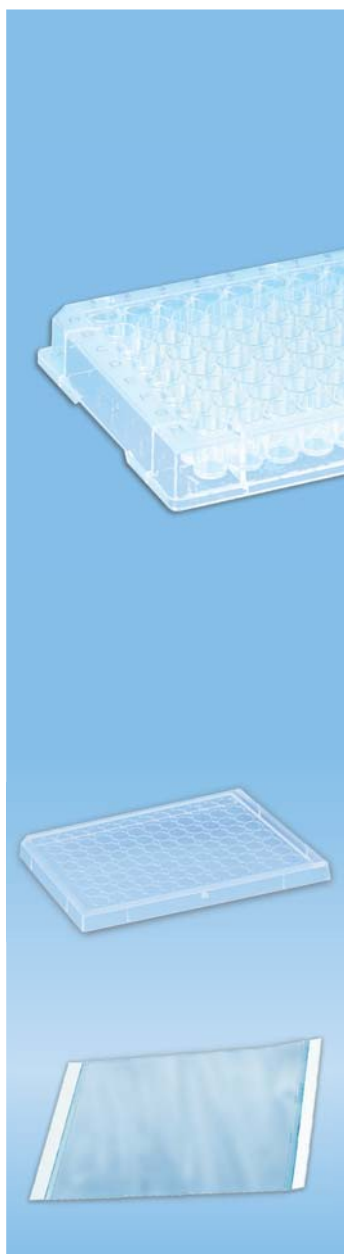

Note: For safety and handling instructions, see p. 220.

Sample handling



Micro test plates, 96-well, made of high-grade crystal-clear polystyrene

- All micro test plates satisfy the ANSI/SLAS (formerly SBS) standard and fit all common dispensers, washers, and readers
- Alphanumeric well identification
- Lot number and expiration date on each plate

Order No.	Description	Base shape	Lid	Max. volume (ml)	Packaging
82.1581	Micro test plate		-	0.39	25/bag 100/case
82.1581.001	Micro test plate, sterile		✓	0.39	1/blister pack 50/case
82.1582	Micro test plate		-	0.31	25/bag 100/case
82.1582.001	Micro test plate, sterile		✓	0.31	1/blister pack 50/case
82.1583	Micro test plate		-	0.29	25/bag 100/case
82.1583.001	Micro test plate, sterile		✓	0.29	1/blister pack 50/case

Accessories for 96-well micro test plates

Order No.	Description	Packaging
82.1584	Polystyrene lid	25/bag 100/case

Adhesive sealing tape for standard applications (covering plates, sample storage)

Order No.	Description	Temperature range	Packaging
82.1586	Transparent, acetate	-40°C to 100°C	100 tapes/box

Additional adhesive sealing tapes, page 107, 130-131.



Terasaki micro test plate

- 60-well plate for analysis with very small sample volumes
- Manufactured from high-grade crystal-clear polystyrene

Order No.	Description	Surface	Base shape	Max. volume	Lid	Packaging
83.9923.972	Terasaki plate, sterile	TC		10 µl	✓	10/bag 650/case

96 deep well MegaBlock® 0.5/1.2/2.2 ml

MegaBlock® 96-well 0.5/1.2/2.2 ml

- Ideal for long-term sample storage
- Each well tested to be 100% leakproof
- Resistant to DMSO solvent (polypropylene block only)
- Square or round wells, all with round bases, and alphanumeric coordinates
- Free from human DNA, RNase/DNase, endotoxins



Order No.	Description	Volume/Description	Packaging units/case
82.1969.002	Round wells	0.5 ml PP (autoclavable)*	56 pcs./case
82.1970.002	Round wells	1.2 ml PS, transparent	32 pcs./case
82.1971.002	Round wells	1.2 ml PP (autoclavable)*	32 pcs./case
82.1972.002	Square wells	2.2 ml PP (autoclavable)*	32 pcs./case

Mat covers for MegaBlock®

95.1990.002		Pierceable cover for 0.5 and 1.2 ml MegaBlock®	10/bag 50/inner box 250/case
95.1991.002		Cover for 2.2 ml MegaBlock®	10/bag 50/inner box 250/case

Adhesive sealing tapes for genomics, HTS, and compound storage

- Reliable sealing of polypropylene, polystyrene and polycarbonate plates
- Heat-tolerant up to 110°C
- Optically transparent (except aluminium option)
- Ideal for safe compound storage
- Provides an effective seal even when using highly hygroscopic solvents
- Excellent resistance to organic solvents such as DMSO, acetonitrile, and methanol



Order No.	Description	Temperature range	Packaging
95.1993	Transparent, polyester	-40°C to 120°C	100 tapes/box
95.1994	Transparent, polyolefin	-70°C to 110°C	100 tapes/box
95.1995	Opaque, aluminium	-70°C to 110°C	100 tapes/box

Sealing tape for standard applications (covering plates, sample storage)

Order No.	Description	Temperature range	Packaging
82.1586	Transparent, acetate	-40°C to 100°C	100 films/box

PP = polypropylene, PS = polystyrene

*see important note on page 219

Sample handling

Multi-purpose cups with snap-on lid



250 ml PS cup, white

Order No.	Length in mm	Opening Ø in mm	Packaging units/case
75.560	100	73	500

Polystyrene snap-on lid

76.561	---	---	500
--------	-----	-----	-----

125 ml PP cup, neutral

Order No.	Length in mm	Opening Ø in mm	Packaging units/case
75.565	85	62	500

125 ml PP cup, highly transparent

Order No.	Length in mm	Opening Ø in mm	Packaging units/case
75.1355	67	66	1000

PE snap-on lid, red, for 125 ml cup (66 mm diameter)

Order No.	Description	Pcs./bag	Packaging units/case
76.1477	With spout	1,000	1,000
76.1477.100	With spout	100	1,000
76.1414	Without spout	1,000	1,000
76.1414.100	Without spout	100	1,000

100 ml PS cup, white

Order No.	Length in mm	Opening Ø in mm	Packaging units/case
75.570	49	70	1,000

PS snap-on lid for 100 ml cup

76.571	---	---	1,000
--------	-----	-----	-------

30 ml PP medicine cup, with graduations

Order No.	Length/Opening Ø in mm	Color	Packaging
75.1337.500	41/37	Neutral	75/bag, 3750/box
75.1337.502	41/37	Red	
75.1337.504	41/37	Yellow	
75.1337.505	41/37	Green	
75.1337.506	41/37	Blue	

PE snap-on lid, white, for 30 ml medicine cup

Order No.: 76.1340.500 3750/case
 Order No.: 76.1340.560 75/bag, 3,750/case

PE = polyethylene, PP = polypropylene, PS = polystyrene

Multi-purpose containers with screw cap



100 ml transparent PP cup, HD-PE screw cap, neutral

Order No.	Length/Ø in mm	Description	Packaging bag/case
75.563	72/62	Cup without cap	50/500
76.564	14/76	Screw cap	50/500
75.562.105	73/62	Cup with cap assembled, sterile, with safety label	5/200
75.562.005	73/62	Cup with assembled cap	5/200
75.562.300	72/62	Cup, cap included	50/250

The safety label shows that the sterile cup has not been tampered with and also provides space for labeling the sample. For brown colored 100 ml cup, see p. 57.



Containers with HD-PE screw caps assembled

Order No.	Material	Volume in ml	Length/Ø in mm	Description	Packaging units/case
75.9922.744	PP	70	55/44	Yellow cap	500
75.9922.745	PP	70	55/44	With label, yellow cap	500
75.9922.721	PP	70	55/44	With label, yellow cap, sterile, individually packed	200
75.9922.421	PP	120	105/44	With graduations up to 120 ml, neutral cap	250
75.9922.420	PP	120	105/44	With graduations up to 120 ml, yellow cap, sterile	250
75.9922.532	PP	250	78/70	With graduations up to 200 ml, neutral cap	240
75.9922.518	PP	250	78/70	With safety label, graduations up to 200 ml, yellow cap, sterile	240
75.9922.534	PP	250	78/70	With graduations up to 200 ml, yellow cap, sterile	240
75.9922.812	PP	500	150/70	With graduations up to 420 ml, neutral cap	120
75.9922.818	PP	500	150/70	With safety label, graduations up to 420 ml, yellow cap, sterile	120
75.9922.813	PP	500	150/70	With graduations up to 420 ml, yellow cap, sterile	120



Tubes with screw caps, 40, 60 and 120 ml

- PP tubes (highly transparent) and caps, autoclavable* at 121°C (see important note on p. 219)

Order No.	Volume in ml	Length/Ø in mm	Description	Packaging units/case
62.555 with graduations	40	85/28.5	Cap included	450
62.555.001 with graduations	40	85/28.5	Cap assembled, sterile	450
60.596	60	126/28.5	Cap included	250
60.596.001	60	126/28.5	Cap assembled, sterile	250
60.597	120	114/42	Cap included	250
60.597.001	120	114/42	Cap assembled, sterile	100

PP = polypropylene, HD-PE = high density polyethylene

* Do not screw cap on tightly when autoclaving.

Storage boxes

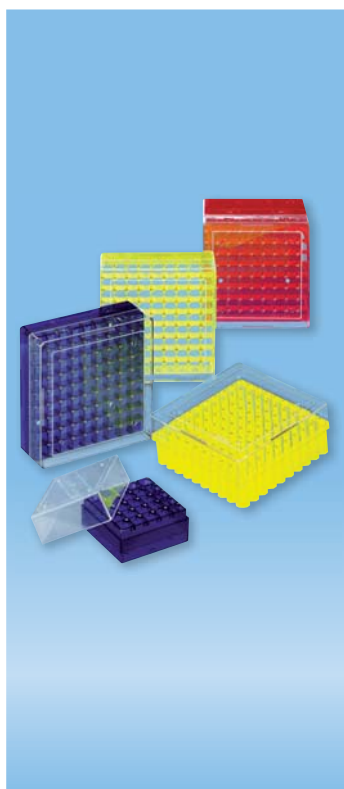

Cryo boxes for deep-freeze storage down to -196 °C

- Durable polycarbonate storage boxes for deep-freeze temperatures down to -196 °C
- Numerical coding at each aperture enables quick sample identification
- Box formats 5 x 5, 9 x 9, and 10 x 10 offer flexible storage options
- Range of box versions to accommodate standard 1.2, 2.0, 3.5 and 5.0 ml cryo tubes
- Autoclavable, 121 °C, 20 min.

Compatible with cryo tubes	1.2–2.0 ml			3.5–5.0 ml
	Format	5 x 5	9 x 9	10 x 10
Storage capacity	25	81	100	81
Box size (W x D x H) in mm	75 x 75 x 52	132 x 132 x 53	132 x 132 x 53	132 x 132 x 95
Ideal for tubes with	Internal and external thread		Internal thread	Internal and external thread

Packaging	Color	Order No.			
5/bag 20/case	Red	93.872.225	93.873.281	93.874.210	93.875.281
	Yellow	93.872.425	93.873.481	93.874.410	93.875.481
	Blue	93.872.625	93.873.681	93.874.610	93.875.681



PP storage boxes for storage down to -90 °C

- High-grade polypropylene (PP) storage boxes
- Numerical coding on box base enables quick sample identification
- Two box formats for tubes up to Ø 12 mm
- Autoclavable at 121°C, 20 min.

Suitable for tubes with maximum dimensions of 45 x 12 mm		
Lid type	Slip-on lid	Hinged lid
Format/storage capacity	9 x 9/81	10 x 10/100
Box size in mm (W x D x H)	130 x 130 x 45	150 x 140 x 55
Box color	Order No.	
Natural	93.876	93.877
Pink	93.876.281	93.877.210
Orange	93.876.381	93.877.310
Yellow	93.876.481	93.877.410
Green	93.876.581	93.877.510
Blue	93.876.681	93.877.610
Packaging		
	5/bag, 20/case	5/bag, 20/case

Storage boxes for 15 & 50 ml tubes

- High-grade polypropylene (PP) storage boxes with slip-on lid
- Numerical coding on box base enables quick sample identification
- Autoclavable at 121°C, 20 min.
- Dimensions L x W x H: 144 x 144 x 127 mm

Order No.	Description	Color	Format/storage capacity	Packaging
93.880	For 15 ml tubes		6 x 6/36	2/bag 12/case
93.881	For 50 ml tubes		4 x 4/16	



Space-saving sample storage boxes

Suitable for SARSTEDT micro tubes, PCR tubes, and centrifuge tubes

- Space-saving and well-organized sample storage
- Safe, light-protected storage

Cold-resistant cardboard boxes with lid and dividers for storage to -80 C

Order No.	Capacity	Format	Dimensions in mm	Max. tube diameter	Tube length in mm
95.064.997	100	10 x 10	135 x 135 x 45 for 1.5 and 2 ml tubes	12 mm	36-45
95.064.981	81	9 x 9	135 x 135 x 45 for 1.5 and 2 ml tubes	13 mm	36-45
95.064.982*	81	9 x 9	135 x 135 x 56 (tall design)	13 mm	35-56
95.064.924	144	12 x 12	135 x 135 x 28 for 0.2 ml tubes	9.5 mm	19-26
95.064.923	100	10 x 10	135 x 135 x 34 for 0.5 ml tubes	12 mm	29-34
95.064.922	49	7 x 7	152 x 152 x 130 for 15 ml tubes	20 mm	88.5-129
95.064.916	16	4 x 4	148 x 148 x 118 for 50 ml tubes	34 mm	89-115

* Version 95.064.982 is suitable for taller tubes such as the 66 x 11.5 mm tube, order no. 60.549 (p. 87).



Styrofoam boxes with lid

Order No.	Dimensions in mm	Max. tube diameter	Capacity/format
95.064.259	85 x 100 x 65	10.8 mm	20/5 x 4
95.064.249	100 x 340 x 65	10.8 mm	100/5 x 20

Styrofoam racks, no lids

Order No.	Dimensions in mm	Max. tube diameter	Capacity/format
95.1439	390 x 80 x 50	11.5 mm	100/5 x 20
95.064.250	416 x 107 x 50	16.5 mm	100/5 x 20
95.064.251	127 x 205 x 46	17 mm	50/5 x 10
95.064.213	338 x 88 x 50	13 mm	100/5 x 20



Miscellaneous hinged storage box

- Made of impact-resistant white plastic (polystyrene)

Order No.	Dimensions in mm	Use
95.066.259	260 x 170 x 80	for bulk goods

'18 series' racks

18-place tube racks, 3x6 format



- Shatterproof material
- Can be autoclaved at 121°C

Rack dimensions

Height	—	40 mm
Length	—	137 mm
Width	—	70 mm

Aperture diameter (see table below)

Upper aperture (casing)	—	d1
Central aperture (central plate)	—	d2
Lower aperture (base plate)	—	d3

Order No.	Aperture diameter in mm			Example of usage
	d1	d2	d3	
93.850.001	17.2	17.2	8	Tubes, square cuvettes, all S-Monovette® diameters
93.850	15.8	15.8	8	Tubes, S-Monovettes of 15 mm and 13 mm diameter
93.827.013	13.5	13.5	8	Tubes and S-Monovettes of 13 mm diameter
93.827	12.8	12.8	8	Tubes, S-Monovettes of 11 mm diameter
93.870	11.5	12.8	4.8	Micro tubes 2 ml, Microvette®
93.826	11.5	7	—	Micro tubes in standard dimensions e.g. 72.690.001, 72.696
93.894	10.5	12.8	4.8	Gripper rack for screw cap micro tubes - notched apertures allow caps to be screwed/unscrewed single-handedly

'20 series' racks

20-place tube racks, 2 x 10 format



- Shatterproof material
- Can be autoclaved at 121°C

Aperture diameter (see table below)

Upper aperture (casing)	—	d1
Central aperture (central plate)	—	d2
Lower aperture (base plate)	—	d3

Order No.	Aperture diameter in mm			Dimensions in mm (H x L x W)	Example of usage
	d1	d2	d3		
93.841.100	26	26	10	60 x 327 x 72	Tubes
93.893.100	21.5	26	10	60 x 327 x 72	Tubes (100 x 21.5 diameter)
93.844.100	17.2	17.2	8.5	55 x 257 x 62	Tubes, all S-Monovette® diameters
93.1097.100*	17.2	17.2	8.5	55 x 257 x 74	Tubes, all S-Monovette® diameters
93.846.100	13.5	13.2	8.5	40 x 257 x 62	Tubes, S-Monovettes of 13 mm and 11 mm diameter
93.849.100	11	11	4.8	40 x 257 x 62	Micro tubes, standard dimensions e.g. 72.690.001, 72.696, 72.695.500, 72.708, Microvette®
93.848.100	10.5	11	4.8	40 x 257 x 62	Gripper rack for screw cap micro tubes – notched apertures allow caps to be screwed/unscrewed single-handedly
93.1102.001	Brown transparent cover			72 x 256 x 62	Cover for rack 93.1097.100 - protects open tubes from contamination

* Rack with pocket for forms

'48 series' racks

48-place tube racks, 4x12 format



- Shatterproof material
- Can be autoclaved at 121°C

Rack dimensions

Height	—	40 mm
Length	—	257 mm
Width	—	90 mm

Aperture diameter (see table below)

Upper aperture (casing)	—	d1
Central aperture (central plate)	—	d2
Lower aperture (base plate)	—	d3

Order No.	Aperture diameter in mm			Example of usage
	d1	d2	d3	
93.1431.001	17.2	17.2	8	Tubes, rectangular cuvettes, all S-Monovette® diameters
93.1431	15.6	15.6	8	Tubes, S-Monovettes of 15 mm and 13 mm diameter
93.838.013	13.5	13.5	8	Tubes and S-Monovettes of 13 mm diameter
93.838	12.2	12.2	8	Tubes, S-Monovettes of 11 mm diameter
93.868	11	11.5	4.8	Micro tubes 2 ml, Microvette®
93.837	11	7	—	Micro tubes in standard dimensions e.g. 72.690.001, 72.696
93.1428	10.5	11.5	4.8	Gripper rack for screw cap micro tubes – notched apertures allow caps to be screwed/unscrewed single-handedly
93.048.011	8	4.5	—	Micro tubes of 8 mm diameter, e.g. 72.699, 72.735.002

Block racks

A universal polypropylene block rack for every laboratory

- 50-place tube racks, 5 x 10 format
- Available in 3 sizes, suitable for all S-Monovette® diameters and for tubes of 8 to 17 mm diameter
- Various colors for laboratory organization and coding
- Ideal for space-saving back-up storage of samples
- Can be autoclaved at 121°C
- Markings on each aperture and printing are available on request
- Rack D17 is also available with handles



Sample handling

Single block rack for 50 tubes



Rack D12

Suitable for S-Monovette® up to diameter 11 mm and tubes up to 12 mm in diameter.
 Dimensions: (length x width x height)
 152 x 80 x 45 mm

Order No.	Color	Packaging units/case
93.854	Gray	20
93.854.121	Red	20
93.854.122	Yellow	20
93.854.123	Green	20
93.854.124	Blue	20
93.854.125	Orange	20

Rack D13

Suitable for S-Monovette® and tubes of Ø 8 mm to Ø 13 mm.
 Dimensions: (length x width x height)
 180 x 96 x 45 mm

Order No.	Color	Packaging units/case
93.853	Gray	16
93.853.131	Red	16
93.853.132	Yellow	16
93.853.133	Green	16
93.853.134	Blue	16
93.853.135	Orange	16

Block racks

Rack D17 with and without handles

Suitable for S-Monovette® up to diameter 16 mm and tubes up to Ø 17 mm

Dimensions: (length x width x height) Without handle: 209 x 109 x 45 mm – With handle: 246 x 109 x 45 mm

Order No.	Color	Handles	Packaging units/case
93.852	Gray 	Without	20
93.851		With	12
93.852.171	Red 	Without	20
93.851.171		With	12
93.852.172	Yellow 	Without	20
93.851.172		With	12
93.852.173	Green 	Without	20
93.851.173		With	12

Order No.	Color	Handles	Packaging units/case
93.852.174	Blue 	Without	20
93.851.174		With	12
93.852.175	Orange 	Without	20
93.851.175		With	12
93.852.168	Brown 	Without	20
93.852.169	Violet 	Without	20
93.852.170	White 	Without	20

Double block rack for 100 tubes

Two racks, firmly joined together. Especially useful for efficient back-up sample storage. These racks are available in gray under the order number shown. Other colors are also available on request. Custom print available on request, minimum quantity 250 pcs.

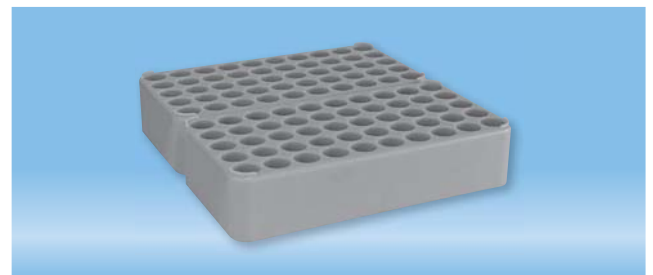
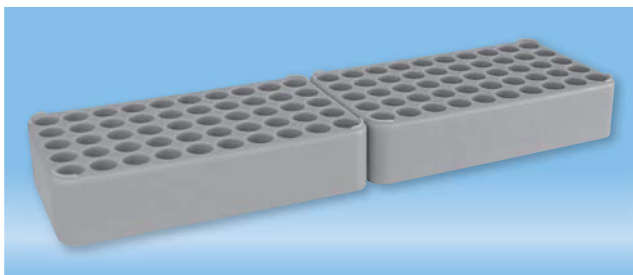

Additional colors on request. Custom print on front/long side available for minimum order quantity of 250 pcs. (front print not available on version D17 with handles).

Double block rack, connected at short side

Order No.	Rack type	Packaging units/case
93.853.300	D13	8
93.852.300	D17	12

Double block rack, connected at long side

Order No.	Rack type	Packaging units/case
93.853.200	D13	8
93.852.200	D17	12

Dimensions of double block rack (length x width x height)

Rack D13 – Long side: 180 x 192 x 45 mm
Short side: 360 x 96 x 45 mm

Rack D17 – Long side: 209 x 218 x 45 mm
Short side: 418 x 109 x 45 mm



Protective cover for block rack, autoclavable

- Fits block rack D17

Order No.	Color	Packaging units/case
93.857	Light gray 	25



IsoFreeze® Rack

- Rack changes color from purple to pink when it warms above the optimum temperature range (above 7°C)
- With the lid closed, the sample temperature can be maintained at 4°C for 3 hours at normal ambient temperatures
- Ideal for temperature-sensitive applications such as investigations of enzymes, PCRs or cell-based assays
- Minimizes the risk of contamination, as there is no need to store samples on ice

Order No.	Capacity	Format	Suitable for	Packaging
95.983	24	4 x 6	1.5 and 2.0 ml push cap and screw cap micro tubes	1/case
95.984	96	8 x 12	0.1 and 0.2 ml PCR plates, strips and single tubes	2/case



Rack for centrifuge tubes

Suitable for tubes up to Ø 30 mm and for 25 ml S-Monovettes

- Autoclavable
- Convenient carrying handles
- Dimensions in mm (W x D x H) 295 x 114 x 65

Order No.	Capacity	Format	Packaging bag/case
93.1707	18	3 x 6	1/10



Rotating workstation

- Stores a wide range of sample tube sizes in a single rack
- Each revolving section contains a variety of openings from 5 mm to 30 mm in diameter
- Colored sections can be rotated, removed, and added
- Suitable for temperature range of -80°C to 121°C

Order No.	Dimensions L x W x H	Packaging bag/case
93.879	108 x 108 x 257 mm	1/4



Our PCR consumables range includes fully compatible products for all common cyclers. The thin-walled design of the tubes optimizes heat transfer, so that the reaction is more specific and the yield greater.

All PCR plates and tubes are certified 'PCR Performance Tested' and guaranteed DNA-free, DNase/RNase-free and free from PCR inhibitors. A wide range of adhesive sealing tapes is available for many applications. To determine the concentration of nucleic acids in the UV field, we offer UV-transparent disposable cuvettes.

Our forensic swabs have a ventilation membrane at the base of the tube, allowing the swab to dry directly in the tube. Thanks to a decontamination process specifically developed for forensic requirements and the ultra-clean production conditions, the absence of DNA is guaranteed.

Our ELISA plates are available with two different protein-binding capacities – medium binding and high binding. The ELISA plates are produced in standard ANSI/SLAS format, so they fit all common dispensers, washers and readers.



SARSTEDT quality seals for laboratory products	120
Multiply® PCR reaction tubes	121-122
Multiply® PCR plates	123-127
Compatibility table for PCR plates	128-129
Adhesive sealing tapes	130-131
UV micro cuvette	131
Forensic swabs	132
ELISA plates	133

Guaranteed reliability and reproducibility

Cleanroom conditions, skilled personnel wearing protective clothing and automated production processes are the prerequisites for the certified SARSTEDT 'PCR Performance Tested' and 'Biosphere® plus' quality standards.

Since 1995, we have provided our customers with product purity certifications tailored to their applications to ensure maximum reproducibility in their analyses. Our certification standards are continuously adjusted so that we can offer the user the required level of purity in their routine work at all times.



PCR performance tested quality · The SARSTEDT quality and purity standard

The 'PCR Performance Tested' certification is tailored to the demands and requirements of work with nucleic acids (e.g. qPCR, PCR, purification and storage). This quality grade allows customers to use SARSTEDT disposables with confidence, directly in nucleic acid analysis.

PCR Performance Tested products meet the following purity criteria, which are certified by an independent laboratory:

- ✓ DNA-free
- ✓ DNase- and RNase-free
- ✓ PCR inhibitor-free

We guarantee that the following limits are not exceeded:

**Human DNA <0.5 pg/μl · Bacterial DNA <0.02 pg/μl · DNase <1x10⁻⁵ U/μl
RNase <1x10⁻⁹ Kunitz units/μl**

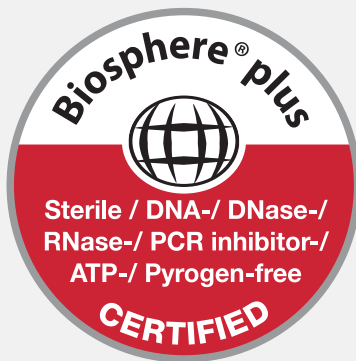

Biosphere® plus quality · Highest purity

Scientific analysis methods have become continuously refined to the point where even individual molecules can now be identified. As sensitivity increases, disposables are required to meet significantly more exacting requirements so that users can be certain that even the smallest contamination will be reliably excluded.

The Biosphere® plus quality constitutes a purity standard that enables the utmost protection against any possible contamination.

In addition to our high purity production conditions, all Biosphere® plus certified products undergo a validated decontamination process. The limits are thus significantly lower than those of the 'PCR Performance Tested' quality. Biosphere® plus items are also free from ATP and pyrogens/endotoxins, and are sterile in accordance with ISO 11135.

Biosphere® plus items fulfil the following purity criteria, which are certified by an independent laboratory:

- ✓ Sterile
- ✓ DNA-free
- ✓ DNase- and RNase-free
- ✓ PCR inhibitor-free
- ✓ ATP-free
- ✓ Pyrogen-free/endotoxin-free

We guarantee that the following limits are not exceeded:

**Human DNA <5.0 fg/μl · Bacterial DNA <0.2 fg/μl · DNase <5x10⁻⁷ U/μl
RNase <5x10⁻¹¹ Kunitz-units/μl · ATP <1x10⁻¹² mmol/μl · pyrogens <0.002 EU/ml
Sterility validated according to ISO 11135**

Multiply® PCR reaction tubes



Multiply® PCR single tubes

- Thin-walled reaction space ensures rapid temperature transfer
- Integral anti-contamination shield on cap allows contamination-free opening
- Flat, frosted cap with large writing area
- Compatible with all common thermocyclers in 0.2 and 0.5 ml block format
- RackSystem workstation is available for processing and storing 0.2 ml tubes (see p. 127)









Multiply® Pro 0.2 and 0.5 ml PCR tubes

- Biosphere® plus (sterile) in small bagged units

Order No.	Max. volume/description	Purity	Packaging
72.735.100	0.5 ml transparent		100/bag 500/inner box 1,000/case
72.737	0.2 ml transparent		250/bag 1,000/inner box 2,000/case



- PCR Performance Tested

Order No.	Max. volume/description	Purity	Packaging
72.735.002	0.5 ml transparent		500/bag 2,000/case
72.735.992	0.5 ml mixed colors: red, orange, green, blue, violet, yellow	 	500/bag 3,000/case
72.737.002	0.2 ml transparent		500/bag 2,000/case
72.737.992	0.2 ml mixed colors: red, orange, green, blue, violet, yellow	 	500/bag 3,000/case

Multiply® PCR strips of 8 reaction tubes

- Thin-walled reaction space ensures rapid temperature transfer
- Optically clear 8-strips with individually attached flat caps, suitable for real-time PCR
- Compatible with 0.2 ml block format thermocyclers
- RackSystem workstation is available for processing and storage (see p. 127)



0.2 ml and 0.1 ml PCR strips of 8/Multiply®-µStripPro with individually attached flat caps

- PCR Performance Tested

Order No.	Max. volume/description	Purity	Packaging
72.991.102	0.2 ml transparent		120 strips/bag 1200 strips/case

- PCR Performance Tested

Order No.	Max. volume/description	Purity	Packaging
72.991.103	0.1 ml low profile / Transparent		120 strips/bag 1200 strips/case



0.2 ml PCR strip of 8/Multiply® μ StripPro with individually attached domed caps

- PCR Performance Tested

Order No.	Description	Purity	Packaging
72.994.002	0.2 ml, domed caps Transparent		120 strips/bag 1,200 strips/case
72.994.992	0.2 ml mixed colors: red, green, blue, violet		120 strips/bag 1,200 strips/case



0.2 ml PCR strip of 8/Multiply®- μ StripPro without lid

- PCR Performance Tested

Order No.	Description	Purity	Packaging
72.985.002	0.2 ml Transparent		120 strips/bag 480 strips/case
72.985.092	0.2 ml white		
72.985.992	0.2 ml mixed colors: red, green, blue, violet		



0.1 ml PCR strip of 8/Multiply®- μ StripPro with lid strip

- PCR Performance Tested

Order No.	Description	Color	Purity	Packaging
72.982.002	0.1 ml, lid strip included	Clear		125 strips/bag 1.250 strips/case
72.982.092	0.1 ml, lid strip included	White		125 strips/bag 1.250 strips/case

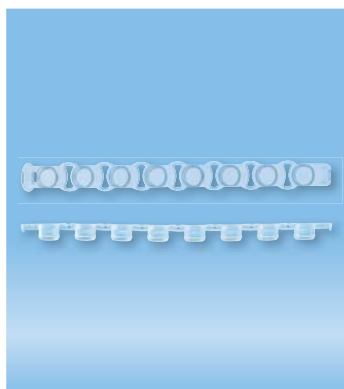

Multiply® lid strip, clear, suitable for real-time PCR

- Biosphere® plus (sterile)

Order No.	Description	Color	Purity	Packaging
65.989	Strip of 8 lids for 72.985.002, 72.985.992 and 72.985.092	Clear		12 strips/bag 240 strips/case

- PCR Performance Tested

Order No.	Description	Color	Purity	Packaging
65.989.002	Strip of 8 lids for 72.985.002, 72.985.992 and 72.985.092	Clear		120 strips/bag 480 strips/case



Centrifuge MC 6

- Ideal for quick centrifuging, microfiltration and spinning down cells
- 6-position fixed angle rotor for 2 ml to 0.2 ml micro tubes, and strip rotor for 2 chains of eight 0.2 ml tubes or single tubes

Order No.	Description
90.186.101	Centrifuge MC 6 115 V, inc. 6-position rotor, strip rotor and adapter sets
92.186.110	Rotor MC 6 – 1.5 ml and 2 ml, 6-position (replacement)
92.186.111	Rotor MC 6 – 0.2 ml, 2 x 8-position (replacement)
92.186.112	Adapter MC 6 for 0.5/0.6 ml micro tubes, pack of 6 (replacement)
92.186.113	Adapter MC 6 for 0.2 ml micro tubes, pack of 6 (replacement)



- Fluorescence level 10x higher
- Greater sensitivity
- Improved reproducibility

Cost-saving miniaturization of qPCR assays in white Multiply® PCR plates

Fluorescence-based applications like real-time PCR (qPCR) require the best possible signal detection, and the fluorescence signal can be significantly affected by the disposable products used.

Compared with transparent tubes, white-colored consumables maximize the fluorescence reflection in qPCR for 10x higher values. Many thermocycler manufacturers therefore recommend the use of white-colored qPCR consumables.

- Markedly improved PCR sensitivity, especially at low template concentrations
- Easily reproducible results
- No crosstalk between individual wells
- Improved signal/background ratio
- Reduce well volumes and reagent costs (by up to 40%) without significantly affecting stability or sensitivity

With white wells, the C_t values are obtained earlier due to maximum signal reflection (see fig. 1). The volume of reagent (SYBR Green) per well can be reduced from 25 μ l to 15 μ l in white plates sealed with qPCR-compatible tapes, without significantly affecting sensitivity or stability (see fig. 2).

Fig. 1

Increased sensitivity due to maximum signal reflection

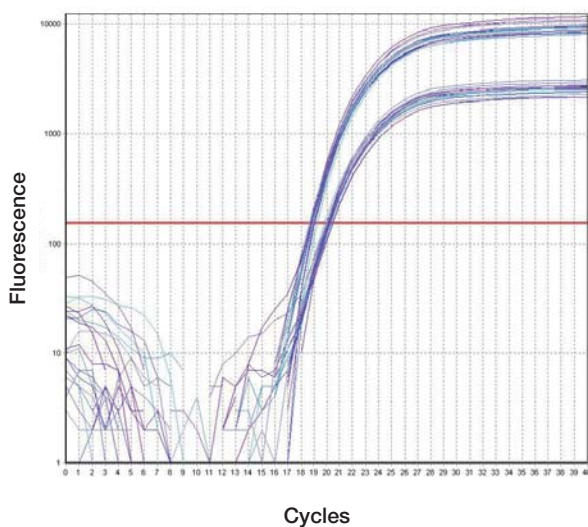
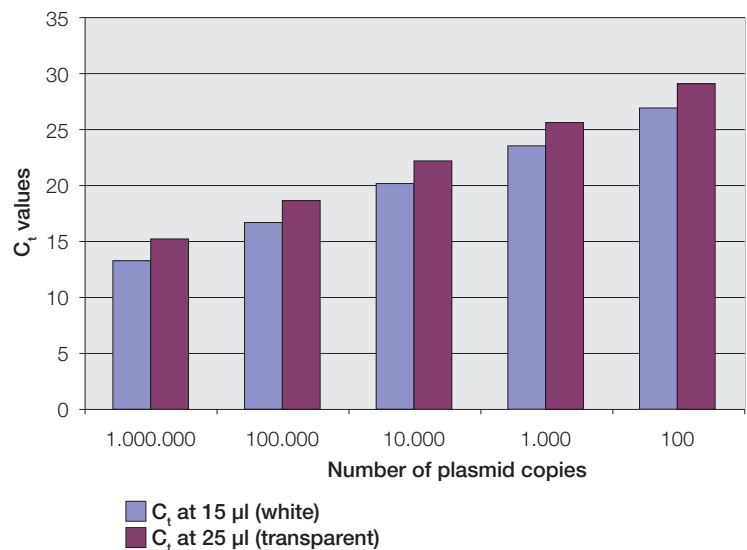

Fig. 2







C_t values for the detection of plasmid copies in white and transparent plates at reduced reaction volumes



White Multiply® PCR plates – optimized for qPCR

- Thin-walled reaction space ensures rapid temperature transfer
- Can be sealed with heat-resistant, highly transparent film (see pp. 130-131) or flat lid strip 65.1998.400 (see p.126)
- Black alphanumeric print for easy well identification
- Certified with the 'PCR Performance Tested' quality seal (free from DNA, DNase-/RNase and PCR inhibitors)



Order No.	Feature	Description/max. volume	Purity	Color	Packaging
72.1978.232	Optimized for qPCR	96-well/0.3 ml without skirt		White	10/bag 50/inner box 200/case
72.1979.132	Optimized for qPCR	ABI-style, 96-well/0.3 ml with half-skirt and flat deck		White	10/bag 50/inner box 100/case
72.1980.232	Optimized for qPCR	96-well/0.1 ml with skirt, low profile for Fast PCR		White	10/bag 50/inner box 200/case
72.1981.232	Optimized for qPCR	ABI-style, 96-well/0.1 ml with half-skirt, low profile for Fast PCR		White	25/bag 100/case
72.1982.202	Optimized for qPCR	Lightcycler 480, 96-well/0.1 ml with half-skirt		White	25/bag 100/case
72.1985.202	Optimized for qPCR	Lightcycler 480, 384 wells/40 µl with full skirt		White	50/bag 100/case

Note: For PCR plate compatibility table, see pp. 128-129.

Multiply® polypropylene PCR plates

- Thin-walled reaction space ensures rapid temperature transfer
- Can be sealed with heat-resistant, highly transparent film (see pp. 130-131) or flat lid strip 65.1998.400 (see p.126)
- Black alphanumeric print for easy well identification
- Certified with the 'PCR Performance Tested' quality seal (free from DNA, DNase-/RNase and PCR inhibitors)





96-well Multiply® PCR plate without skirt

- Fits common thermocyclers/DNA sequencers
- Raised well rims for optimum sealing with adhesive tapes

Order No.	Description/ max. vol.	Color	Purity	Packaging
72.1978.202	96-well/ 0.3 ml	Transparent		5/bag 25/inner box 100/case

96-well Multiply® PCR plate with half-skirt

- PCR plate for Applied Biosystems thermocyclers/DNA sequencers
- Frame allows barcoding and use in automated systems

Order No.	Description/ max. vol.	Color	Purity	Packaging
72.1979.202	96-well/0.3 ml	Transparent		25/bag 100/case
72.1979.203	96-well/0.3 ml with barcode	Transparent		25/bag 100/case

96-well Multiply® PCR plate with half-skirt and flat deck

- Recommended for Applied Biosystems (ABI) thermocyclers and DNA sequencers
- Flat deck allows wells to be sealed with film easily and securely

Order No.	Description/ max. vol.	Color	Purity	Packaging
72.1979.102	96-well/0.3 ml	Transparent		5/bag 25/inner box 100/case

384-well Multiply® PCR plate with robust skirt

- SBS-compliant PCR plate with rigid frame for all common thermocyclers/DNA sequencers
- Raised well rims for optimum sealing with adhesive tapes

Order No.	Description/ max. vol.	Color	Purity	Packaging
72.1984.202	384-well/40 µl	Transparent		25/bag 50/case

Note: For PCR plate compatibility table, see pp. 128-129.

Multiply® polypropylene PCR plates

- Thin-walled reaction space ensures rapid temperature transfer
- Can be sealed with heat-resistant, highly transparent film (see pp. 130-131) or flat lid strip 65.1998.400
- Black alphanumeric print for easy well identification
- Certified with the 'PCR Performance Tested' quality seal (free from DNA, DNase-/RNase and PCR inhibitors)



96-well Multiply® PCR plate with skirt for robotic systems and real-time thermocyclers

- SBS-compliant
- Low profile design minimizes dead volume and cycle time
- Frame allows barcoding and use in automated systems

Order No.	Description/ max. vol.	Color	Purity	Packaging
72.1980.202	96-well/ 0.1 ml	Transparent		10/bag 50/inner box 200/case

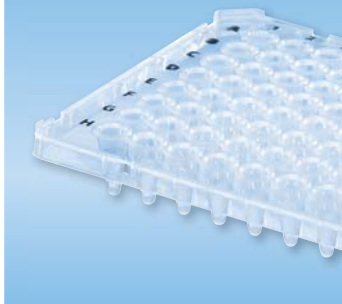

96-well Multiply® Fast PCR plate with half-skirt for ABI Fast PCR systems (ABI Prism 9800 and 7500 Fast)

- Low profile design minimizes dead volume and cycle time
- Ultra-clear thin-walled wells ensure even temperature transfer
- Suitable for common thermocyclers

Order No.	Description/ max. vol.	Color	Purity	Packaging
72.1981.202	96-well/ 0.1 ml	Transparent		25/bag 100/case

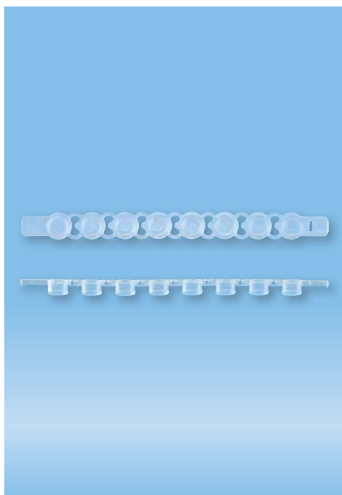

Multiply® strip of 8 flat lids, clear, for real-time PCR

- PCR Performance Tested

Order No.	Packaging	Purity	Compatible with
65.1998.400	300 lid strips/inner box • 1,200 lid strips/case		Suitable for all 96-well Multiply® PCR plates, white and transparent

Note: For PCR plate compatibility table, see pp. 128-129.

Multiply® strips without lids, pre-inserted into PCR work tray, 96-well format

- Thin-walled reaction space ensures rapid temperature transfer
- Can be used on thermocyclers in 0.2 ml block format
- Biosphere® plus certified, individually wrapped and sterile
- Compatible with SARSTEDT RackSystem (bottom of page)



Order No.	Description	Purity	Packaging
72.985	0.2 ml transparent Biosphere® plus, sterile		1/bag 20/case

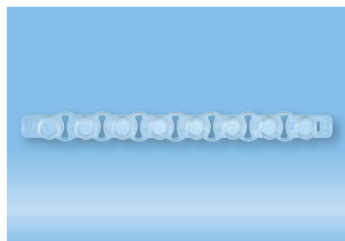

Multiply® strip of 8 flat lids, clear, suitable for real-time PCR

- Biosphere® plus (sterile)

Order No.	Purity	Packaging	Compatible with
65.989		12 lid strips/bag 240 lid strips/case	PCR plate 72.985

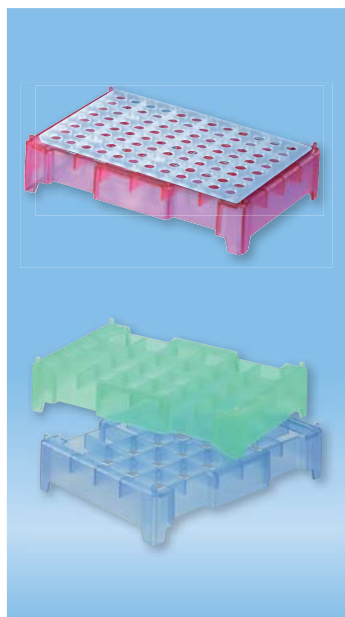

RackSystem storage and pipetting station for 0.1 ml and 0.2 ml Multiply® PCR tubes and preloaded PCR work trays

- Flexible 2-part system comprised of work tray and support base
- Work tray can be used directly in thermocyclers without moving tubes
- 96-well format for use with automated systems
- Stackable for space-saving sample storage
- Autoclavable at 121 °C (see important note on p. 219)

Order No.	Description	Color	Packaging
95.987.002	PCR work tray for 96 tubes	Transparent	5 pcs./bag
95.988	Support base for PCR plates and work tray	Transparent	5 pcs./case
95.988.001		Red	5 pcs./case
95.988.002		Blue	5 pcs./case
95.988.003		Green	5 pcs./case
95.988.004		Yellow	5 pcs./case

You can find our IsoFreeze® rack for temperature-dependent applications on page 117.

Compatibility table for PCR plates

Number of wells	96 in tray	96	96	96	96	384
Half/full skirt	Without	Without	Half	Full	Half	Full
Profile	High	High	High	Low	Low	-
Order no. PCR plates	72.985	72.1978.202 72.1978.232	72.1979.102 72.1979.132 72.1979.202 72.1979.203	72.1980.202 72.1980.232	72.1981.202 72.1981.232	72.1984.202
Amersham Biosciences®/GE Healthcare®						
MegaBACE 500/1000 DNA Analysis System				●		
MegaBACE 4000 DNA Analysis System						●
Analytik Jena®/Biometra®						
FlexCycler ² 96-well		●				
qTOWER 2.0/2.2 SP	●	●		●		
SpeedCycler ² 96-well SP & SPR	●	●		●		
TAdvanced	●	●				
TOptical	●	●		●		
TRobot 96-well	●	●		●		
TRobot 384-well						●
TProfessional family 96-well (except TRIO)		●		●		
TProfessional family 384-well (except TRIO)						●
Applied Biosystems®/Life Technologies®						
GeneAmp® 2700/2720		●	●			
GeneAmp® 7500/5700		●	●			
GeneAmp® 9600	●	●	●			
GeneAmp® 9700	●	●	●			
GeneAmp® 9800 FAST Block					●	
PE 2700		●	●			
PE 9600	●	●	●			
PE 9700	●	●	●			
Prism® 2720		●	●			
Prism® 7000/7700		●	●			
Prism® 7300/7500			●			
Prism® 7500 Fast					●	
Prism® 7900HT			●			●
Prism® 7900 Fast					●	
Prism® 7900HT Fast					●	●
QuantStudio™			●			
StepOne Plus™					●	
Veriti® 96-well/384-well			●			●
Veriti® Fast 96-well			●		●	
ViiA7™			●		●	
310 Genetic Analyzer		●	●		●*	
3100/3130 Genetic Analyzer		●	●		●*	
3500/ 3500XL Genetic Analyzer			●		●*	
3700/3730/3730XL Genetic Analyzer		●	●		●*	
PeqLab®						
peqSTAR 96		●	●	●		
peqSTAR 384						●
Thermo Fisher Scientific®						
MultiBlock System		●		●		●
PCR Sprint		●		●		

Key:  = recommended  = not checked

*with a suitable ABI adapter

The compatibility table shows usage recommendations for the products listed. SARSTEDT does not routinely test plates for their compatibility with the listed devices. Product characteristics therefore cannot be guaranteed.

Compatibility table for PCR plates

Number of wells	96 in tray	96	96	96	96	384	96	384
Half/full skirt	Without	Without	Half	Full	Half	Full	Full	Full
Profile	High	High	High	Low	Low	-	'Lightcycler'	'Lightcycler'
Order no. PCR plates	72.985	72.1978.202 72.1978.232	72.1979.102 72.1979.132 72.1979.202 72.1979.203	72.1980.202 72.1980.232	72.1981.202 72.1981.232	72.1984.202	72.1982.202	72.1985.202
BioRad®/MJ Research®								
CFX96 Touch™ Real-Time PCR				●	●			
CFX384 Touch™ Real-Time PCR						●		
CFX Automation System II								
T100™ Thermal Cycler	●	●		●				
S1000™ Thermal Cycler		●	●	●		●		
C1000Touch™ Thermal Cycler		●	●	●		●		
iCycler iQ™ Thermal Cycler	●	●	●					
iQ4™ Thermal Cycler	●	●	●					
iQ5™ Thermal Cycler	●	●	●					
MyCycler™ Thermal Cycler	●	●	●					
Chromo4™		●		●				
Opticon™, Opticon2™				●				
BaseStation™				●				
Corbett Research®/Qiagen®								
Palm Cycler 96-well		●						
Palm Cycler 384-well				●				
Eppendorf®								
Mastercycler® nexus	●	●						
Mastercycler® ep realplex		●	●			●		
Mastercycler® gradient	●	●		●				
Mastercycler® ep gradient	●	●	●	●				
Mastercycler® pro	●	●		●				
Ericom®								
Deltacycler			●	●				
SingleBlock			●	●				
TwinBlock			●	●				
MWG®								
Primus 96 advanced®		●						
Primus 96-well		●		●				
Primus 384-well						●		
The Q-Lifecycler		●	●	●				
Roche®								
Lightcycler® 96 System							●	
Lightcycler® 480 System							●	●
Stratagene®/Agilent®								
AriaMx Real-Time PCR System				●				
Mx3000P™	●	●						
Mx3005P™	●	●	●	●				
Mx4000™	●	●	●					
Gradient Cycler		●		●				
Robocycler 384-well						●		
Techne®								
Cyclogene		●		●				
Flexigene		●	●	●				
Genius/Genius Quad		●	●	●				
OMN-E		●	●					
PCR Express	●	●	●			●		
Primus 96		●						
Px2/PxE		●	●			●		
Quantica			●	●		●		
TC412/TC512		●		●		●		
Touchgene/Touchgene Gradient		●	●	●	●			

Adhesive sealing tapes

Specially designed adhesive film materials are required for hermetically sealing polypropylene, polystyrene and polycarbonate micro test plates to prevent evaporation and protect samples during use, storage, and shipping.

A variety of SARSTEDT sealing tapes are available for the demands of PCR, substance storage, and high throughput screening. All tapes are produced under cleanroom conditions to prevent contamination with DNase/RNase and nucleic acids.

Our sealing tapes are compatible with aqueous solutions and organic solvents such as DMSO, acetonitrile, and methanol.

Highly transparent adhesive tape for quantitative PCR

The 50 µm thin tape is coated with a transparent adhesive that shows minimal adhesion at room temperature and is easy to handle and reposition. Strong adhesion takes place only when the film is pressed down and through the thermal effect of the PCR process, minimizing evaporation losses.

- **Highly transparent tape** for real-time PCR and other fluorescence-based applications
- **Superior seal** due to innovative adhesive
- **Does not stick to skin or gloves** during application

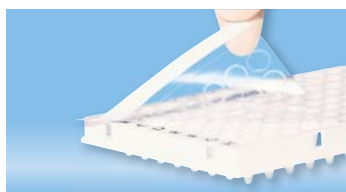

Order No.	Description	Packaging
95.1999	Highly transparent qPCR tape with pressure-sensitive adhesive	100 tapes/box

Aluminium tape for PCR and sample storage

This heat-resistant, strong but pierceable aluminium tape offers impressively high protection from evaporation and resistance to solvents. Perforated end tabs can easily be removed once the tape has been applied.

- **Pierceable aluminium foil**
- **Ideal for sample storage down to -70°C**

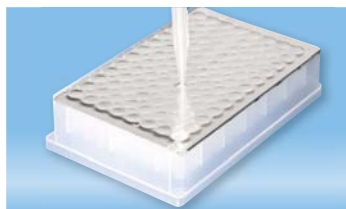

Order No.	Description	Packaging
95.1995	Aluminium sealing tape	100 tapes/box

Transparent adhesive tape for quantitative PCR and end-point PCR

This optically clear film is suitable for qPCR and has perforated end tabs for easy separation.



Order No.	Description	Packaging
95.1994	Transparent sealing tape	100 tapes/box

Transparent tape with strong adhesive for PCR and sample storage



Order No.	Description	Packaging
95.1993	Transparent sealing tape with strong adhesive	100 tapes/box

Recommended tape options

SARSTEDT PCR sealing tapes: application recommendations						
Order No.	Description	Application	Special properties	Pierceable	Material	Functional temperature range
95.1999	Adhesive, highly transparent qPCR tape	Real-time PCR, fluorescence analyses	Highly transparent, pressure-sensitive innovative adhesive	No	Polyolefin	-70°C to 100°C
95.1995	Adhesive aluminium tape	Sample storage, PCR	Pierceable, protects samples from light, high chemical resistance	Yes	Aluminium	-70°C to 110°C
95.1994	Transparent PCR and qPCR tape	PCR, real-time PCR	Good optical clarity, high chemical resistance	No	Polyolefin	-70°C to 110°C
95.1993	Transparent PCR tape	PCR, sample storage	Strong adhesive, eliminates edge effects, resealable	No	Polyester	-40°C to 120°C

UV micro cuvette

The plastic material of the UV cuvette enables measurements in the UV range at wavelengths of 220 nm upwards. The UV-transparent disposable cuvette eliminates contamination associated with washing quartz cuvettes. In addition to non-certified UV cuvettes, certified UV cuvettes are also available that are individually sealed with a cap. All UV cuvettes are packed in Styrofoam boxes to prevent scratches.

Typical applications and product features

- Photometric quantification of nucleic acids at 260 nm and proteins at 280 nm
- Minimal UV absorption for DNA, RNA and protein quantification
- Minimum sample volume: 50 µl
- Suitable for photometers with a light center height (CH) of 8.5 mm and 15 mm: Eppendorf Biophotometer, ThermoSpectronic, Perkin Elmer, Bio-Rad, Analytik Jena, etc.
- Certified DNA/RNase/protein-free UV cuvettes are individually sealed with lids for safe sample storage and prevention of contamination



UV micro cuvette

Order No.	Height in mm	CH	Packaging
67.758	45	8.5 mm	100/Styrofoam box, 400/case
67.758.001	45	8.5 mm	100/Styrofoam box, 400/case (individually sealed with cap, certified DNA-/RNase-/protein-free)
67.759	45	15 mm	100/Styrofoam box, 400/case
67.759.001	45	15 mm	100/Styrofoam box, 400/case (individually sealed with cap, certified DNA-/RNase-/protein-free)

Forensic swabs

Maximum purity for forensic requirements

SARSTEDT forensic swabs can be used both for collecting reference samples and trace DNA evidence at crime scenes. Both polystyrene and wood stem options are available. Forensic swab L with extended handle is useful for the hygienic collection of reference samples. For securing evidence in sexual assault cases, forensic swab XL with a long stem is available. A pointed swab is available for securing evidence under the fingernails, for example.



Forensic swabs

- DNA-free
- EtO sterilized
- Self-drying within the tube
- Individually sterile wrapped or with tamper-proof closure

DNA-free

The production process for forensic swabs is carried out under strictly controlled and hygienic conditions. The finished swab is then wrapped and the final product is subjected to an EtO sterilization process specifically developed for forensic requirements. To verify the absence of DNA, forensic swabs are then subjected to a test procedure with a **detection limit of 0.5 pg DNA/ μ l extraction volume**. A 73 bp amplicon also facilitates detection of partially degraded DNA (target gene: human cytochrome oxidase).

Drying behavior

A ventilation membrane in the tube base enables the swab to dry safely and protected in the tube by itself. There is no need to dry the swab outside the tube in the open, as is usually required in other systems, thereby excluding the risk of mix-up and contamination. A dry swab is necessary to prevent bacteria and mold growth, which can render analysis impossible and therefore destroy the sample.

Order No.	Description	Ø/tube length in mm	Stem material/length in mm	Swab material	Packaging
80.629	Forensic swab	15/102	PS/90	Viscose	1/blister 100/inner box 500/case
80.629.001	Forensic swab	15/102	Wood/95	Cotton	1/blister 100/inner box 500/case
80.629.101	Forensic swab, pointed	15/102	Wood/95	Cotton	1/blister 100/inner box 500/case
80.630	Forensic swab L	12/105	PS/85	Viscose	1/tamper-proof wrapper 50/inner box 500/case
80.634	Forensic swab XL	12/150	PS/125	Viscose	1/tamper-proof wrapper 50/inner box 500/case



ELISA plates made of high-grade polystyrene

- Micro test plates for immunoanalytics with medium binding or high binding surfaces
- Alphanumeric well identification
- Pyrogen-free/endotoxin-free and non-cytotoxic
- Products marked with surface property, batch number, and expiration date
- Black and white ELISA plates for fluorescence and luminescence assays

Order No.	Description	Surface	Base shape	Color	Max. volume	Packaging
82.1581.100	ELISA plate	Medium		Transparent	0.39 ml	25/bag 50/case
82.1581.200	ELISA plate	High		Transparent	0.39 ml	25/bag 50/case
82.1581.110	ELISA plate	Medium		White	0.39 ml	25/bag 50/case
82.1581.210	ELISA plate	High		White	0.39 ml	25/bag 50/case
82.1581.120	ELISA plate	Medium		Black	0.39 ml	25/bag 50/case
82.1581.220	ELISA plate	High		Black	0.39 ml	25/bag 50/case
82.1582.100	ELISA plate	Medium		Transparent	0.31 ml	25/bag 50/case
82.1582.200	ELISA plate	High		Transparent	0.31 ml	25/bag 50/case
82.1583.100	ELISA plate	Medium		Transparent	0.29 ml	25/bag 50/case
82.1583.200	ELISA plate	High		Transparent	0.29 ml	25/bag 50/case

Lid for ELISA and micro test plates

Order No.	Description	Packaging
82.1584	Polystyrene lid	25/bag 100/case

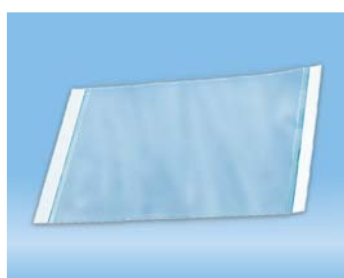

Sealing tape for standard applications (covering ELISA plates, sample storage)

Order No.	Description	Temperature range	Packaging
82.1586	Transparent	-40°C to 100°C	100/box



Dosing, transferring and measuring liquids is part of almost every laboratory routine. We have a vast product range of high quality pipette tips, serological pipettes and transfer pipettes to meet every application and requirement, ensuring reliable and reproducible results.

Our many years' experience in manufacturing pipette tips guarantees a secure, reliable fit on all common pipettes. Highly transparent material, molded graduation rings, and precise pipette cone fit are factors that distinguish our tried and trusted quality tips. For special applications, we offer defined purity certifications (Biosphere® plus and PCR Performance Tested), low retention materials, and filter tips. Color-coded trays, the tip SystemBox, and the tip StackPack system guarantee flexible, efficient, and easy handling of our pipette tips.

For dosing volumes of up to 50 ml, we offer serological pipettes made of crystal-clear polystyrene. Individually sterile wrapped, pyrogen-free/endotoxin-free and non-cytotoxic, they are especially suitable for cell culture work.

Our Liquid Handling product portfolio is complemented by our unbreakable transfer pipettes, which minimize the risk of injury and enable safe transfer of small quantities of liquid.



Pipette tips	136–147
SARSTEDT quality seals	136
Low retention pipette tips	138–139
Quality pipette tips with filters	140
Quality pipette tips without filters	141
Compatibility table – pipette tips	142–145
Tip SystemBox · Tip StackPack refill system	146–147
Transfer pipettes	148–149
Serological pipettes	150–151
Pipetting aids	151

Guaranteed reliability and reproducibility

Cleanroom conditions, skilled personnel wearing protective clothing and automated production processes are the prerequisites for the certified SARSTEDT "PCR Performance Tested" and Biosphere® plus quality standards.

Since 1995, we have provided our customers with product purity certifications tailored to their applications to ensure maximum reproducibility in their analyses. Our certification standards are continuously adjusted so that we can offer the user the required level of purity in their routine work at all times.



PCR performance tested quality · The SARSTEDT quality and purity standard

The "PCR Performance Tested" certification is tailored to the demands and requirements of work with nucleic acids (e.g. qPCR, PCR, purification and storage). This quality grade allows customers to use SARSTEDT disposables with confidence, directly in nucleic acid analysis.

PCR Performance Tested products meet the following purity criteria, which are certified by an independent laboratory:

- ✓ DNA-free
- ✓ DNase- and RNase-free
- ✓ PCR inhibitor-free

We guarantee that the following limits are not exceeded:

**Human DNA <0.5 pg/μl · Bacterial DNA <0.02 pg/μl · DNase <1x10⁻⁵ U/μl
RNase <1x10⁻⁹ Kunitz units/μl**

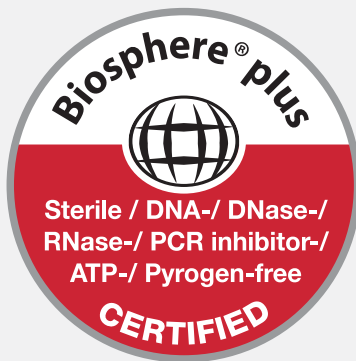

Biosphere® plus quality · Highest purity

Scientific analysis methods have become continuously refined to the point where even individual molecules can now be identified. As sensitivity increases, disposables are required to meet significantly more exacting requirements so that users can be certain that even the smallest contamination is reliably excluded.

The Biosphere® plus quality constitutes a purity standard that enables the utmost protection against any possible contamination.

In addition to the high purity production conditions, all Biosphere® plus certified products undergo a validated decontamination process. The limits are thus significantly lower than those of the "PCR Performance Tested" quality. Biosphere® plus items are also free from ATP and pyrogens/endotoxins, and are sterile in accordance with ISO 11135.

Biosphere® plus items fulfil the following purity criteria, which are certified by an independent laboratory:

- ✓ Sterile
- ✓ DNA-free
- ✓ DNase- and RNase-free
- ✓ PCR inhibitor-free
- ✓ ATP-free
- ✓ pyrogen-free/endotoxin-free

We guarantee that the following limits are not exceeded:

**Human DNA <5.0 fg/μl · Bacterial DNA <0.2 fg/μl · DNase <5x10⁻⁷ U/μl
RNase <5x10⁻¹¹ Kunitz-units/μl · ATP <1x10⁻¹² mmol/μl · pyrogens <0.002 EU/ml
Sterility validated according to ISO 11135**

The pipette tip – a critical factor in precise dosing

The accuracy of the pipetting process depends largely on the coordination of pipette and pipette tip. As one of the leading global manufacturers of pipette tips, SARSTEDT's objective is to offer you top quality, reliable tips for the most common pipette brands.

The quality of a pipette tip is defined by the characteristics of the material from which it is made (e.g. chemical resistance), its surface quality (e.g. low retention), its design (e.g. graduation rings, reduced aerosol formation) and its proper fit on the corresponding pipette.

Our quality guarantee: Conformity testing according to the international ISO 8655-2 standard

The trend towards ever smaller sample volumes places increasingly rigorous demands on consumables. To guarantee maximum precision and reliability even with very small volumes, SARSTEDT tips are regularly checked in combination with the pipettes of leading manufacturers in the market (e.g. Eppendorf®, Gilson®). Tips undergo comprehensive conformity testing in accordance with the international ISO 8655-2 standard for piston pipettes. We guarantee that our pipette tips, together with the piston pipettes listed from the specified manufacturers, form a system that does not exceed the accuracy and precision tolerances of ISO 8655-2.

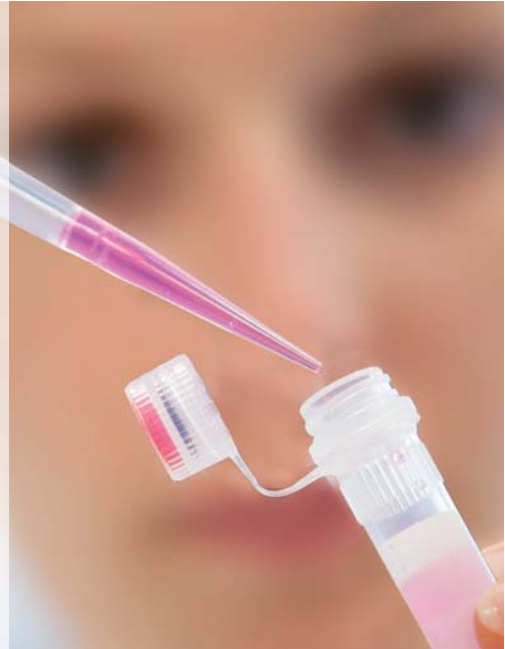

Prevention of contamination and carryover using selected filter materials

Even the most meticulous pipetting may generate aerosols during sample aspiration that can make their way into and contaminate the pipette.

With many applications (PCR, microbiological and radioactive pipetting) contamination of the pipette cannot be tolerated. To eliminate cross-contamination and the associated consequences (erroneous results, additional work and extra costs), pipette tips are used which incorporate special porous filter elements.

The filter elements positioned in SARSTEDT pipette tips consist of a synthetic material that has defined hydrophobic properties and no self-sealing additives.

The high efficacy of our filter elements is achieved by means of a complex mechanism involving absorption, surface quality, thickness, strength and shape, and is verified through two independent processes (PCR and P-32 marked ATP).*

* Refer to our application report 'Shielding effect of filter inserts in pipette tips' for further details.

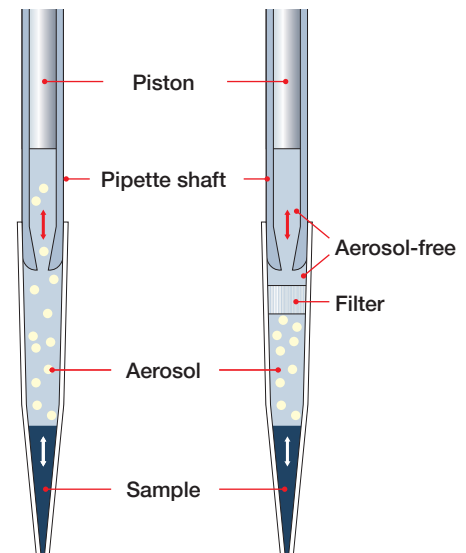

Low retention pipette tips

Optimized surfaces for improved sample recovery

- Cost-savings on expensive reagents such as growth factors, assay kit reagents, restriction enzymes, polymerases and PCR master mixes
- Improved research results from greater reproducibility of experiments
- Maximum pipetting accuracy through increased sample recovery
- Significantly improved pipetting of highly viscous liquids such as glycerine, buffer solutions and detergents



Comparative illustration of average pipetting losses

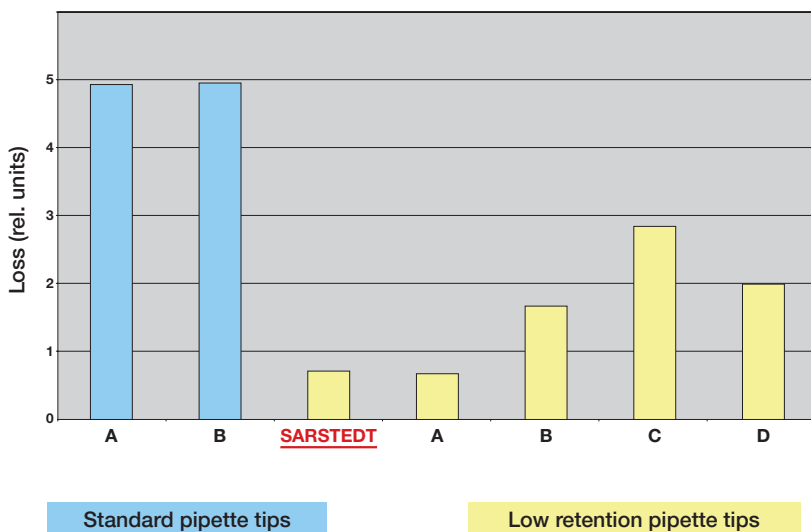

Using 200 µl pipette tips from various suppliers, 100 µl of a test liquid containing dyes (H₂O; 0.1% (w/v) Triton X-100; 0.25% (w/v) brilliant cresyl blue) was aspirated and dispensed with an electronic pipette at a constant pipetting rate.





Residues in the pipette tips were washed out through repeated flushing with 200 µl water into a cuvette, and subjected to photometric comparison. The test was repeated ten times for each supplier; the calculated mean values are shown in the accompanying diagram.

Low retention pipette tips









































Ordering information – low retention pipette tips with filters, Biosphere® plus quality

Figure	Order No.	Volume	Quality Grade	Packaging
 Type E	70.1130.217	2.5 µl		96/box, 480/inner carton, 1,920/case
 Type E	70.1130.215	10 µl		96/box, 480/inner carton, 1,920/case
 Type N	70.1114.215	20 µl		96/box, 480/inner carton, 1,920/case
 Type J	70.1116.215	20 µl		96/box, 480/inner carton, 1,920/case
 Type A	70.760.219	20 µl		96/box, 480/inner carton, 1,920/case
 Type A	70.760.217	100 µl		96/box, 480/inner carton, 1,920/case
 Type A	70.760.216	200 µl		96/box, 480/inner carton, 1,920/case
 Type L	70.765.215	300 µl		96/box, 480/inner carton, 1,920/case
 Type B	70.762.216	1,000 µl		100/box, 500/inner carton, 1,000/case

































Ordering information – low retention pipette tips without filters

Figure	Order No.	Volume	Packaging
 Type E	70.1130.105	10 µl	96/box, 1,920/case
 Type N	70.1114.105	20 µl	96/box, 1,920/case
 Type J	70.1116.105	20 µl	96/box, 1,920/case
 Type A	70.760.107	200 µl	96/box, 1,920/case
 Type L	70.765.105	300 µl	96/box, 1,920/case
 Type B	70.762.105	1,000 µl	100/box, 1,000/case

Quality pipette tips with filters

Filter tips (illustrations: actual size)	Tray color code	Order No.	Max. sample volume/ color	Quality Grade	Packaging
	Type E 	70.1130.212	2.5 µl, neutral		96/box, 480/inner carton, 1,920/case
	Type E 	70.1130.210	10 µl, neutral		96/box, 480/inner carton, 1,920/case
		70.1130.410			480/bag (loose), 4,800/case
	Type N 	70.1114.210	20 µl, neutral		96/box, 480/inner carton, 1,920/case
		70.1114.410			480/bag (loose), 4,800/case
	Type J 	70.1116.210	20 µl, neutral		96/box, 480/inner carton, 1,920/case
	Type A 	70.760.213	20 µl, neutral		96/box, 480/inner carton, 1,920/case
		70.760.413			480/bag (loose), 4,800/case
	Type A 	70.760.212	100 µl, neutral		96/box, 480/inner carton, 1,920/case
		70.760.412			480/bag (loose), 4,800/case
	Type O, extra long  Half actual size	70.1189.215	200 µl, neutral		96/Box, 960/case
	Type C 	70.760.211	200 µl, neutral		96/box, 480/inner carton, 1,920/case
		70.760.411			480/bag (loose), 4,800/case
	Type L 	70.765.210	300 µl, neutral		96/box, 480/inner carton, 1,920/case
	Type B 	70.762.211	1,000 µl, neutral		100/box, 500/inner carton, 1,000/case
		70.762.411			200/bag (loose), 2,000/case
	Type M  Half actual size	70.1186.210	1,250 µl, neutral		96/Box, 768/case
		70.1186.410			384/bag (loose), 3,840/case

Quality pipette tips without filters

Tips without filters (illustrations: actual size)	Tray color code	Order No.	Max. sample volume/color	Quality Grade	Packaging
		70.1130			1,000/bag, 10,000/case
		70.1130.100			96/box, 1,920/case
		70.1130.200	10 µl, neutral		96/box, 480/inner carton, 1,920/case
		70.1130.600			96/tray, 576/StackPack, 2,304/case
		70.1130.460			96/tray, 576/StackPack, 2,304/case
		70.1114			1,000/bag, 10,000/case
		70.1114.100	20 µl, neutral		96/box, 1,920/case
		70.1114.200			96/box, 480/inner carton, 1,920/case
		70.1116			1,000/bag, 10,000/case
		70.1116.100	20 µl, neutral		96/box, 1,920/case
		70.1116.200			96/box, 480/inner carton, 1,920/case
		70.760.002	200 µl, neutral		500/bag, 10,000/case
		70.760.012	200 µl, yellow		500/bag, 10,000/case
		70.760.102	200 µl, neutral		96/box, 1,920/case
		70.760.202	200 µl, neutral		96/box, 480/inner carton, 1,920/case
		70.760.502	200 µl, neutral		96/tray, 480/StackPack, 1,920/case
		70.760.452	200 µl, neutral		96/tray, 480/StackPack, 1,920/case
 Half actual size		70.1189.105	200 µl, neutral		96/box, 960/case
 Half actual size		70.1190.100	200 µl, neutral		96/box, 960/case
		70.760.001			500/bag, 10,000/case
		70.760.201	250 µl, neutral		96/box, 480/inner carton, 1,920/case
		70.760.501			96/tray, 480/StackPack, 1,920/case
		70.760.451			96/tray, 480/StackPack, 1,920/case
		70.765			500/bag, 5,000/case
		70.765.100	300 µl, neutral		96/box, 1,920/case
		70.765.200			96/box, 480/inner carton, 1,920/case
		70.762	1,000 µl, neutral		250/bag, 5,000/case
		70.762.010	1,000 µl, blue		250/bag, 5,000/case
		70.762.100	1,000 µl, neutral		100/box, 1,000/case
		70.762.200	1,000 µl, neutral		100/box, 500/inner carton, 1,000/case
 Half actual size		70.1186			384/bag, 3,840/case
		70.1186.100	1,250 µl, neutral		96/box, 3,840/case
		70.1186.200			96/box, 768/case
 Half actual size		70.1183.001	5 ml		250/bag, 2,500/case
		70.1183.101			50/box, 500/case
 Half actual size		70.1183.002	5 ml		250/bag, 2,500/case
		70.1183.102			50/box, 500/case
 Half actual size		70.1187.001	10 ml		200/bag, 2,000/case
		70.1187.101			25/box, 250/case

Compatibility table – pipette tips

pipette tips with filters

(illustrations: half actual size)

Eppendorf® pipettes

	Illustration	Part Number	Eppendorf Reference®					Eppendorf Research®					Eppendorf Research® plus														
			0.1-2.5 µl	0.5-10 µl	2-20 µl	2-20 µl	10-100 µl	50-200 µl	100-1,000 µl	0.1-2.5 µl	0.5-10 µl	2-20 µl	10-100 µl	20-200 µl MC	30-300 µl MC	100-1,000 µl	500-5,000 µl	1-10 ml	0.1-2.5 µl	0.5-10 µl MC	2-20 µl	2-20 µl	10-100 µl MC	20-200 µl	30-300 µl MC		
2.5 µl		70.1130.212 70.1130.217	●	●	●				●	●								●	●	●	●						
10 µl		70.1130.210 70.1130.215 70.1130.410		●	10				X	●								X	●	10							
20 µl		70.1114.210 70.1114.215 70.1114.410	●	●	●				●	●								●	●	●							
20 µl		70.1116.210 70.1116.215	●	●	●				●	●								●	●	●							
20 µl		70.760.213 70.760.219 70.760.413			●	●	●			X	●	●	X							●	●	●	X				
100 µl		70.760.212 70.760.217 70.760.412			●	●	100			●	●	100	X							●	●	100	X				
200 µl		70.1189.215			●	●	●			●	●	●								●	●	●					
200 µl		70.760.211 70.760.216 70.760.411			X	X	●			X	X	●	X							X	X	●	X				
300 µl		70.765.210 70.765.215			X	X	●			X	X	●	●									●	●				
1,000 µl		70.762.211 70.762.216 70.762.411					●						●														
1,250 µl		70.1186.210 70.1186.410					●						●														

Pipette tips without filters (illustrations: half actual size)

	Illustration	Part Number	Eppendorf Reference®					Eppendorf Research®					Eppendorf Research® plus														
			0.1-2.5 µl	0.5-10 µl	2-20 µl	2-20 µl	10-100 µl	50-200 µl	100-1,000 µl	0.1-2.5 µl	0.5-10 µl	2-20 µl	10-100 µl	20-200 µl MC	30-300 µl MC	100-1,000 µl	500-5,000 µl	1-10 ml	0.1-2.5 µl	0.5-10 µl MC	2-20 µl	2-20 µl	10-100 µl MC	20-200 µl	30-300 µl MC		
10 µl		70.1130 70.1130.100 70.1130.105 70.1130.200 70.1130.600	●	●	●				●	●								●	●	10							
20 µl		70.1114 70.1114.100 70.1114.105 70.1114.200	●	●	●				X	●								●	●	●							
20 µl		70.1116 70.1116.100 70.1116.105 70.1116.200	●	●	●				●	●								●	●	●							
200 µl		70.760.002 70.760.102 70.760.107 70.760.202 70.760.502			●	●	●			●	●	●	X							●	●	●	X				
200 µl		70.1189.105			●	●	●			●	●	●								●	●	●					
250 µl		70.760.001 70.760.201 70.760.501			●	●	●					●	X								●	●	X				
300 µl		70.765 70.765.100 70.765.105 70.765.200			X	X	●			X	X	●	●							X	X	●	●				
1,000 µl		70.762 70.762.100 70.762.105 70.762.200					●						●														
1,250 µl		70.1186 70.1186.100 70.1186.200					●						●														
5 ml		70.1183.001 70.1183.101																		X							
5 ml		70.1183.002 70.1183.102																		●							
10 ml		70.1187.001 70.1187.101																				●					

● = compatible
 10 = limited pipetting volume
 X = not recommended

□ = not checked
 MC = multi-channel pipette

Compatibility table – pipette tips

pipette tips with filters

(illustrations: half actual size)

Biohit® pipettes

		mLine® Mechanical						Proline® Mechanical						eLine® Electronic										
		0.5-10 µl MC	2-20 µl	10-100 µl	20-200 µl	30-300 µl MC	100-1,000 µl	100-5,000 µl	0.1-2.5 µl	0.5-10 µl	5-50 µl	5-50 µl MC	20-200 µl	50-250 µl MC	50-300 µl MC	100-1,000 µl	100-5,000 µl	0.2-10 µl	10-300 µl	50-1,000 µl	50-1,200 µl MC	100-5,000 µl	0.1-1 µl	
2.5 µl	70.1130.212 70.1130.217	●	●						●	●								●					●	×
10 µl	70.1130.210 70.1130.215 70.1130.410	●	●						●									●					●	×
20 µl	70.1114.210 70.1114.215 70.1114.410	●																						
20 µl	70.1116.210 70.1116.215	●	●						●	●								●					●	×
20 µl	70.760.213 70.760.219 70.760.413			×	×	×				●	●	×	×	×					×					
100 µl	70.760.212 70.760.217 70.760.412			×	●					●	●	●	×	×					×					
200 µl	70.1189.215		●	●	●					●	●													
200 µl	70.760.211 70.760.216 70.760.411			×	●					×	×	●	●	●	●				×					
300 µl	70.765.210 70.765.215			×	●	●				×	×	●	●	●					●					
1,000 µl	70.762.211 70.762.216 70.762.411						●									●				●	×			
1,250 µl	70.1186.210 70.1186.410						●									●					×			

Pipette tips without filters (illustrations: half actual size)

		mLine® Mechanical						Proline® Mechanical						eLine® Electronic										
		0.5-10 µl MC	2-20 µl	10-100 µl	20-200 µl	30-300 µl MC	100-1,000 µl	100-5,000 µl	0.1-2.5 µl	0.5-10 µl	5-50 µl	5-50 µl MC	20-200 µl	50-250 µl MC	50-300 µl MC	100-1,000 µl	100-5,000 µl	0.2-10 µl	10-300 µl	50-1,000 µl	50-1,200 µl MC	100-5,000 µl	0.1-1 µl	
10 µl	70.1130 70.1130.100 70.1130.105 70.1130.200 70.1130.600	●	●						●	●								●					●	
20 µl	70.1114 70.1114.100 70.1114.105 70.1114.200	●																						
20 µl	70.1116 70.1116.100 70.1116.105 70.1116.200	●	●						●	●								●					●	×
200 µl	70.760.002 70.760.102 70.760.107 70.760.202 70.760.502			×	●	×				●	●	×	×	×					×					
200 µl	70.1189.105		●	●	●					●	●													
250 µl	70.760.001 70.760.201 70.760.501			×	●					●	●	●	●	●	●	250			×					
300 µl	70.765 70.765.100 70.765.105 70.765.200			×	●	●				×	×	●	●	●					●					
1,000 µl	70.762 70.762.100 70.762.105 70.762.200						●									●				●	×			
1,250 µl	70.1186 70.1186.100 70.1186.200						●									●					×			
5 ml	70.1183.001 70.1183.101							×									×					×		
5 ml	70.1183.002 70.1183.102						●									●							●	
10 ml	70.1187.001 70.1187.101																							

- = compatible
- 10 = limited pipetting volume
- ×

- = not checked
- MC = multi-channel pipette



Gelloader pipette tips

- Fine, extra-long capillary
- Easily fill agarose or SDS gels
- Compatible with the most common pipettes

Order No.	Volume	Packaging
70.1190.100	200 µl	96/box • 960/case

The Tip SystemBox as a central pipetting station

Simple and practical

Economical and environmentally friendly

Tip StackPack packaging
Efficient handling of 96-tip trays, reducing packaging and storage space required in the Tip SystemBox

Flexible and good value

Empty 96-tip refill trays and bulk, bagged tips
Fill empty trays in the Tip SystemBox for convenient handling and autoclaving*



Tip SystemBox

The autoclavable tip box is the central workstation for all trays of 96 SARSTEDT tips (see important note on page 219).

Complete with hinged lid and non-slip base, the Tip SystemBox readily accommodates tip StackPack refill trays or empty trays for racking bulk tips.

Order No.	Description	Packaging units/case
95.1298.001	Empty Tip SystemBox (without pipette tips)	6

Empty refill trays for use in the Tip SystemBox

For customers who buy our bulk, bagged tips, we offer empty trays (gray, yellow and orange).

- Place the empty tray into the Tip SystemBox and fill with tips
- If required, autoclave the tips in the Tip SystemBox

Order No.	Tray color code	Tip type*/volume	Packaging units/case
95.1760.011		A, C/ 200 µl	25
95.1760.022		J, N/ 20 µl	25
95.1760.034		E/ 10 µl	25
95.1760.044		L/ 300 µl	20

* For tip type, see pp. 140-141.

Tip StackPack refill pack



Tip StackPack refill system

Flexible, efficient and easy to use

Tips are preloaded in stacked trays of 96, reducing packaging waste and storage space by over 50%.

- Economical and eco-friendly
- For high throughput, tips can be used directly from the stack. Simply break through the safety labels on both sides to access the next layer.
- Single trays can be removed and placed directly and securely in the Tip SystemBox.

Order No.	Quality Grade	Volume	Color code	Packaging
70.1130.460		10 µl		576/StackPack 2,304/case
70.1130.600		10 µl		576/StackPack 2,304/case
70.760.452		200 µl		480/StackPack 1,920/case
70.760.502		200 µl		480/StackPack 1,920/case
70.760.451		250 µl		480/StackPack 1,920/case
70.760.501		250 µl		480/StackPack 1,920/case



Empty boxes for bulk, bagged tips, 1,000–1,250 µl

Order No.	Tip type	Empty box	Packaging units/case
95.1762	B - 1,000 µl tips (order no.: 70.762)	Base, tray, lid	10
95.1763	M - 1,250 µl tips (order no.: 70.1186)	Base, tray, lid	8

Transfer pipettes

- Simple liquid transfer
- Unbreakable; no risk of injury or infection from broken glass
- Single-use; no carry-over or cross-contamination
- Convenient graduations for sample distribution
- Can be used for storage and transport by heat-sealing the end of the pipette
- Made of polyethylene, a pure hydrocarbon compound, with no environmentally harmful substances, ensuring non-toxic disposal

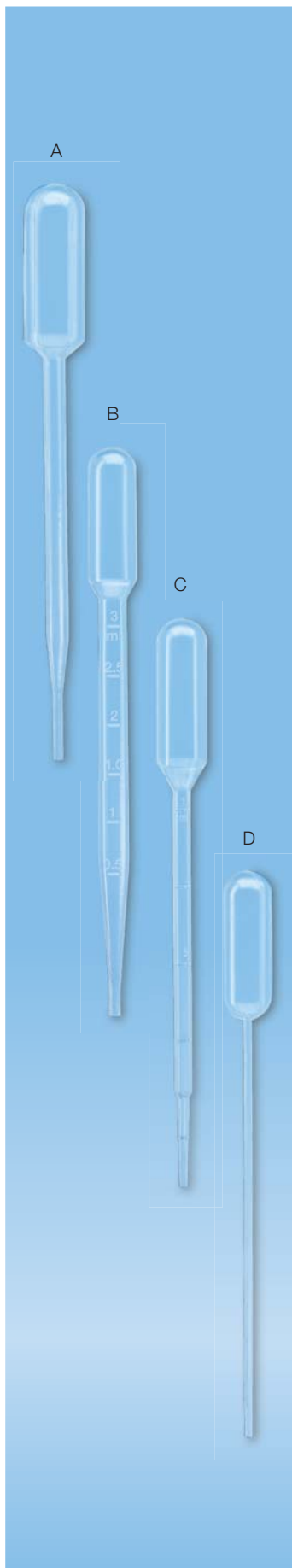

LD-PE transfer pipettes

Order No.	Type	Length in mm	Bulb volume	Droplet size	Graduations	Packaging inner carton/ case
86.1174.300	A	152	6.0 ml	40-55 μ l	–	400/4,000
86.1171.300	B	155	3.5 ml	35-55 μ l	0.5–3.0 ml 3:0.50 (0.5 per step)	500/5,000
86.1172.300	C	156	3.5 ml	30-45 μ l	0.25–1.0 ml 1:0.25 (0.25 per step)	500/5,000
86.1173.300	D	155	3.5 ml	30-45 μ l	–	500/5,000
86.1175.300	E	146	6.0 ml	20-30 μ l	–	400/4,000
86.1176.300	F	154	2.0 ml	35-45 μ l	–	500/5,000
86.1170.300	G	115	1.0 ml	45-55 μ l	0.1–1.0 ml 1:0.1 (0.1 per step)	500/4,000
86.1180	H	104	1.0 ml	17-22 μ l	–	400/3,200
86.1179.300	I	87	1.0 ml	30-45 μ l	–	500/4,000

Transfer pipettes

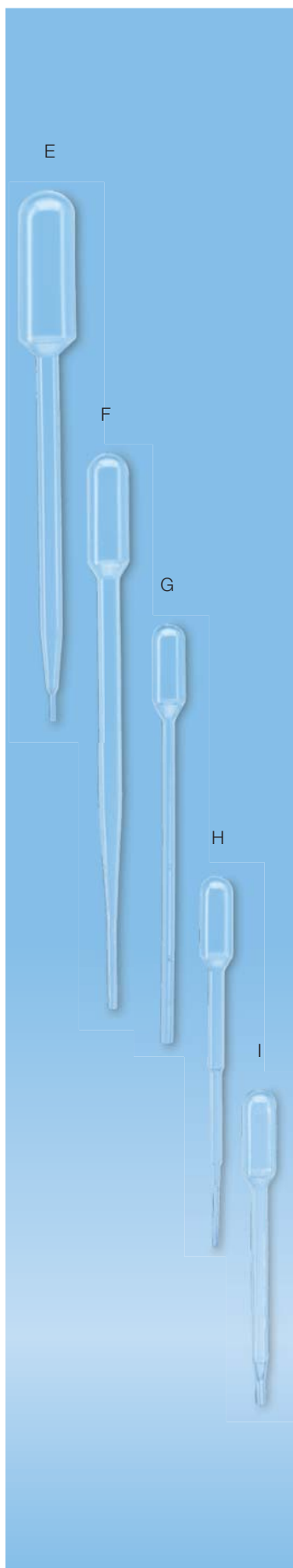

LD-PE transfer pipettes, individually sterile wrapped

Order No.	Type	Length in mm	Bulb volume	Droplet size	Graduations	Packaging bag/case
86.1171.301	B	155	3.5 ml	35-55 μ l	0.5–3.0 ml 3:0.50 (0.5 per step)	500/4,000
86.1172.301	C	156	3.5 ml	30-45 μ l	0.25–1.0 ml 1:0.25 (0.25 per step)	500/4,000
86.1173.001	D	155	3.5 ml	30-45 μ l	–	500/4,000

LD-PE transfer pipettes, sterile packs of 20

Order No.	Type	Length in mm	Bulb volume	Droplet size	Graduations	Packaging bag/case
86.1171.020	B	155	3.5 ml	35-55 μ l	0.5–3.0 ml 3:0.50 (0.5 per step)	500/4,000
86.1172.020	C	156	3.5 ml	30-45 μ l	0.25–1.0 ml 1:0.25 (0.25 per step)	500/4,000
86.1173.020	D	155	3.5 ml	30-45 μ l	–	500/4,000
86.1174.020	A	152	6.0 ml	40-55 μ l	–	400/3,200
86.1175.020	E	146	6.0 ml	20-30 μ l	–	400/3,200

LD-PE = low density polyethylene
Other sizes of sterile packed transfer pipettes available on request.

Serological pipettes

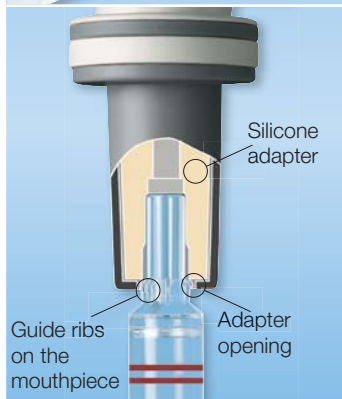
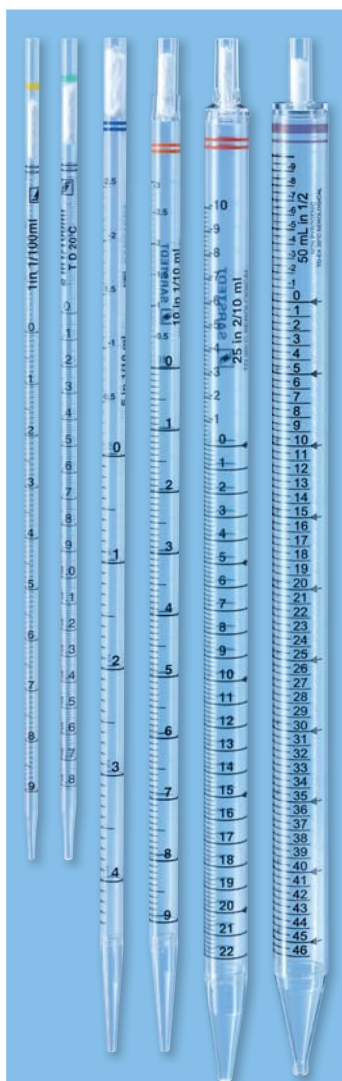

Serological pipettes made from transparent polystyrene

- Individually sterile packed serological pipettes are pyrogen-free/endotoxin-free and non-cytotoxic
- Simple identification using international color code on the pipette and on the blister pack
- Larger pipetting volume due to negative graduations
- Variable working methods due to reverse scaling
- Universal fit in the most common pipetting aids
- Easy to open, static-free packaging

Serological pipettes 1 ml, 2 ml, 5 ml, 10 ml, 25 ml, 50 ml

Order No.	Total volume/graduations		Description	Color code	Packaging units/case
86.1251.001	1 ml	1/100 ml	Plugged, ind. wrapped, sterile		1/1,000
86.1251.025	1 ml	1/100 ml	Plugged, sterile, 25 pcs.		25/1000
86.1252.001	2 ml	1/100 ml	Plugged, ind. wrapped, sterile		1/1,000
86.1252.025	2 ml	1/100 ml	Plugged, sterile, 25 pcs.		25/1000
86.1253.001	5 ml	1/10 ml	Plugged, ind. wrapped, sterile		1/500
86.1253.025	5 ml	1/10 ml	Plugged, sterile, 25 pcs.		25/500
86.1254.001	10 ml	1/10 ml	Plugged, ind. wrapped, sterile		1/500
86.1254.025	10 ml	1/10 ml	Plugged, sterile, 25 pcs.		25/500
86.1685.001	25 ml	2/10 ml	Plugged, ind. wrapped, sterile		1/200
86.1685.020	25 ml	2/10 ml	Plugged, sterile, 20 pcs.		20/200
86.1256.001	50 ml	1/2 ml	Plugged, ind. wrapped, sterile		1/90

Aspiration pipette, polystyrene

- For aspirating liquids using a vacuum pump
- Individually packaged in paper/plastic peel packaging
- Certified pyrogen-free/endotoxin-free and non-cytotoxic
- Without print, without cotton plug

Order No.	Total volume	Description	Packaging units/case
86.1252.011	2 ml	without plug, without print, ind. wrapped, sterile	1,000

25 ml serological pipette in optimized design

Due to their weight, 25 ml pipettes generally have a considerable range of movement in pipetting aid adapters. This makes it more difficult to handle them and to dispense the precise amount of sample material and in the worst cases can lead to a poor seal between the pipette and the adapter.

- Small guide ribs on the mouthpiece of the pipette provide an improved fit in the pipetting aid adapter, to minimize undesirable motion of the filled pipette
- The close contact between the guide ribs and the adapter housing (see illustration) minimizes dripping from unwanted movement



Dilution pipette 1.1 ml, with and without tip

For producing dilutions for bacteriological investigations, e.g. in food laboratories, plugged, sterile wrapped

Order No.	Total volume/graduations		Description	Packaging bag/case
86.1686.225	1.1 ml	0.5 – 1.0 – 1.1 ml	Without tip	25/bag 1,000/case
86.1686.025	1.1 ml	0.5 – 1.0 – 1.1 ml	With tip	25/bag 1,000/case

Pipettes 5 ml and 10 ml without tip, e.g. for homogenized media

Order No.	Total volume/graduations		Description	Packaging bag/case
86.1687.010	5 ml	1/10 ml	Plugged, sterile, 10/bag	500
86.1688.010	10 ml	1/10 ml	Plugged, sterile, 10/bag	500

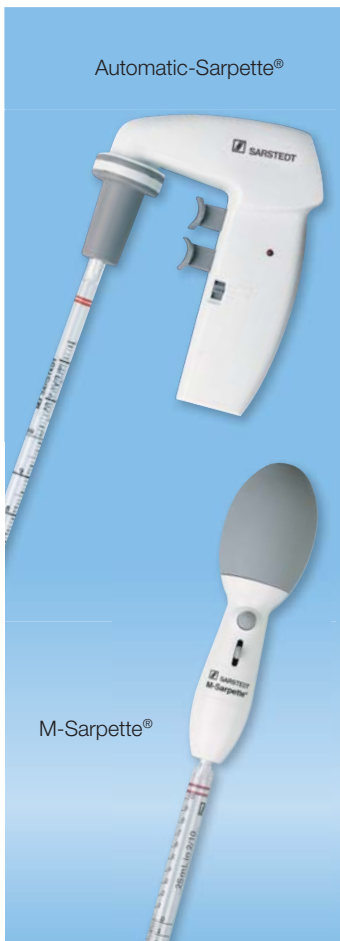

Automatic-Sarpette®

- Ergonomic shape
- Lightweight to minimize fatigue
- Nickel metal hydride battery
- Two speeds and free dispensing
- Integrated hydrophobic membrane filter functions as fluid barrier.

Order No.: 90.1416

Inc. recharger and stand

M-Sarpette®

- No batteries or power necessary
- Weighs considerably less than automatic pipetting aids
- Reliable and controlled pipetting via special valve system
- Integral hydrophobic filter functions as fluid barrier
- Compatible with 1–100 ml pipettes

Order No.: 90.1427

Replacement parts for Automatic & M-Sarpette®

Order No.	Description	Packaging units/case
92.189.121	Replacement filter 0.2 µm	5
92.1417.001	Replacement filter 0.45 µm	5
92.1417.002	Silicone adapter	1



The successful cultivation of cells *in-vitro* requires the simulation of the *in vivo* environment of the relevant cell type as accurately as possible. To meet the requirements for as many different cell types as possible, we offer flasks, dishes, and plates with three different growth surfaces.

miniPERM® is an easy-to-use bioreactor for cultivating cells in high densities. The sub-division of the bioreactor into production and nutrient modules, together with rotating cultivation, enables the production of highly concentrated cell products in small volumes.

The x-well cell culture system comprises slides made of various materials, a polystyrene frame with single- or multi-chambers and various growth surfaces.

lumox® cell culture products are characterized by their ultra-thin, gas-permeable film base. Gas permeability and short diffusion paths ensure optimum gas exchange and high optical clarity.

For sterile filtration – of cell culture media, for example – we offer a wide range of options from 1 ml to 10 l. Filter membranes are available with different pore sizes for a wide range of applications.



Cell culture	
Quality seals and color coding system	154–155
Cell culture flasks	156–157
Cell culture dishes	158
Cell scrapers	159
Cell culture plates · Coverslips	160–161
TC inserts	162–163
miniPERM® bioreactor	164–165
lumox®	166
x-well®	167
flexiPERM® · quadriPERM®	168
Filtration	
Filtropur V	169
Filtropur S · Filtropur L	170
Tubes	
Tissue culture and centrifuge tubes	171

Come Grow With Us – SARSTEDT quality seals for cell and tissue culture products

Cell and tissue cultures are used not only in basic research but also increasingly in applied biotechnology and in clinical and pharmaceutical research. Products of the highest possible purity and quality are required for toxicity tests, quality controls of biochemical processes, industrial production systems (e.g. production of monoclonal antibodies) and many more applications. Compliance with quality standards for cell and tissue culture is necessary to ensure that experiments are comparable and reproducible.

For more than 25 years, SARSTEDT has produced a wide range of certified consumables for working with cell and tissue cultures.



TC tested

Since 1990, SARSTEDT has offered its customers high-quality cell culture products produced in cleanroom conditions by trained personnel wearing protective clothing and using automated production processes.

In accordance with our basic principle that products which come into contact with cells must not have a disruptive effect on the cells, these products are produced under the strictest cleanroom conditions and are labeled with the 'TC tested' quality logo. These cell culture products meet the following requirements:

- **Sterile** Compliant with ISO 11137 'Sterilization of health care products – validation and routine control of sterilization with radiation'
- **Pyrogen-free/endotoxin-free** Based on the LAL test as per the FDA guideline for medical devices, detection limit < 0.06 EU/ml
- **Non-cytotoxic** In compliance with ISO 10993 – 'Biological Evaluation of Medical Devices – Part 5, Tests for *in-vitro* cytotoxicity'
- **DNA-free** Test method: Real time PCR; limit of detection of human DNA < 0.5 pg/μl, bacterial DNA < 0.02 pg/μl
- **Free from DNase and RNase** Test method: Fluorescence assay; limit of detection of DNase $7.1 \cdot 10^{-5}$ U/μl, RNase $7.1 \cdot 10^{-9}$ U/μl

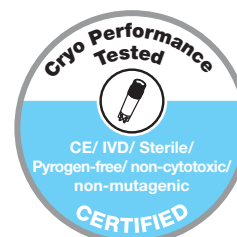

Cryo Performance Tested (see p. 104)

During 'vital preservation' in CryoPure tubes, cell and tissue samples must not be exposed to additional contamination risks from disruptive substances. Upon successfully meeting stringent testing criteria, SARSTEDT CryoPure tubes are certified as follows:

- **Sterile** Compliant with ISO 11137 'Sterilization of health care products – validation and routine control of sterilization with radiation'
- **Pyrogen-free/endotoxin-free** Based on the LAL test as per the FDA guideline for medical devices, detection limit < 0.06 EU/ml
- **Non-cytotoxic** In compliance with ISO 10993 – 'Biological Evaluation of Medical Devices – Part 5, Tests for *in-vitro* cytotoxicity'
- **Non-mutagenic** The evidence for assessing freedom from mutagens was gathered based on the Ames Test II
- **IVD**

SARSTEDT growth surfaces and color coding

A basic requirement for the successful cultivation of cells *in-vitro* is to simulate the *in vivo* environment of the relevant cell type as accurately as possible. The surface condition of the culture vessel is particularly important because many cell types can only survive, proliferate and differentiate following successful adhesion. To meet the requirements for as many different cell types as possible, SARSTEDT offers flasks, dishes and plates with three different growth surfaces. To ensure clear identification even after removal from the packaging, the products are labeled according to the SARSTEDT color coding system as follows:

SARSTEDT standard surface for adherent cells

Hydrophilic groups are introduced into the surface by means of a special treatment of the polystyrene surface. This allows cell surface proteins to form, enabling the cells to adhere to the plastic surface. The hydrophilic standard growth surface, which is coded red, therefore provides an optimum culture substrate for many adherent cells.

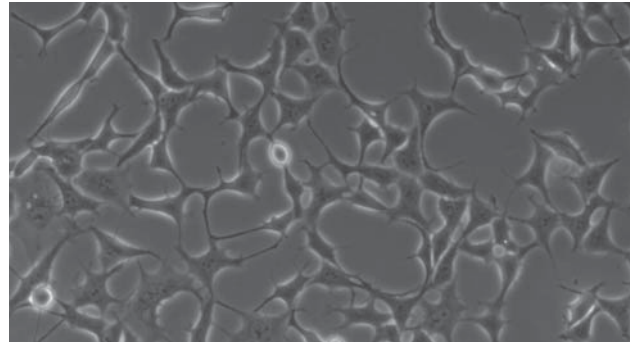

SARSTEDT Cell+ surface for difficult adherent cell types

Primary cells, sensitive cell culture lines, and cells which are cultivated under serum-reduced/serum-free conditions have particularly high requirements of the surface of the cell culture vessel. The yellow-coded Cell+ growth surface was developed specifically for such cells. Additional polar groups are introduced into the hydrophilic surface by means of a special treatment of the plastic surface. This leads to improved imitation of the *in vivo* environment and therefore to the adhesion of difficult cell types. Due to its properties, the Cell+ surface can make the use of coated culture vessels redundant in many cases.

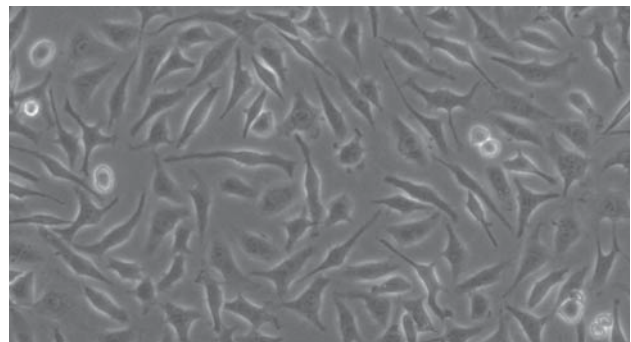

SARSTEDT suspension culture surface

Culture vessels with the green coded, hydrophobic growth surfaces are ideally suited for suspension cells (usually cells of lymphoid origin, hybridoma cells etc.) that are not adherently cultivated in solution. The hydrophobic surface minimizes cell losses caused by unwanted microadhesion during sub-cultivation.

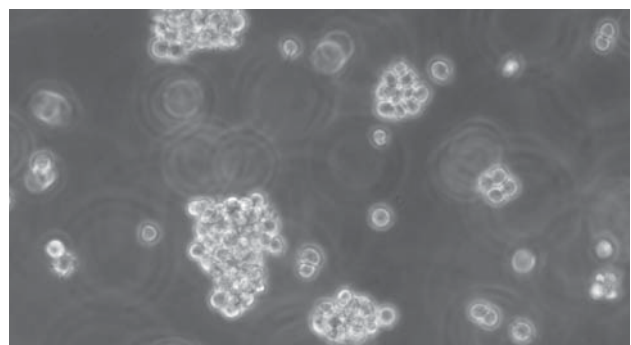

100 μ m

By cultivating different cell types on SARSTEDT growth surfaces, the vitality of the various cell types can be readily recognized.* a) HEK293 cells cultivated for 48 hours on the standard TC surface. b) CHO cells cultivated under serum-reduced conditions (1%) for 24 hours on the Cell+ surface. c) Jurkat cells cultivated for 72 hours on the suspension cell surface. The measurement scale bar represents 100 μ m.

* A list of successfully cultivated cells is available on request for the various growth surfaces.



Cell culture flasks

For cell culture, SARSTEDT offers flasks with a growth surface of 25 cm², 75 cm² and 175 cm². All cell culture flasks are made of high-grade transparent polystyrene processed into a flat growth surface that is ideal for microscopic observation. All cell culture flasks are tested and certified with the 'TC tested' quality seal (see p. 154).



Product characteristics of SARSTEDT cell culture flasks

- All corners accessible with serological pipettes and cell scrapers. ①
- Large labeling fields on both sides of the neck and printed and molded graduations facilitate use of the products. ②
- Highly stable and stackable design
- The optimized canted neck and the anti-drip rim allow the medium to be tilted easily without spilling and contamination. ③
- Lot number and expiration date are printed on each flask for easy traceability after removal from the packaging. ④
- All SARSTEDT tissue culture flasks are available with three different growth surfaces and can be clearly identified from the colored caps:

-  Red = for adherent cells
-  Yellow = for difficult adherent cells
-  Green = for suspension cells



Caps

The Quick-Release cap is particularly user-friendly, because only a 1/3 turn is needed to close or open it. When several cell culture flasks are being processed in parallel, the caps are often simply placed on the neck of the flask. To prevent accidental self-closing the cap thread features a defined 'stop'. When closing, this 'stop' can be felt as light resistance. The ribbed Quick-Release cap is available in two designs:

- The **two-position screw cap** enables gas-tight sealing of the flasks when it is in the closed position and even gas exchange while in the ventilation position (arrows pointing up and down). A recognizable click confirms that the cap is locked in the ventilation position and will not fall off. A gap in the ribbing and arrows on the cap provide for simple tactile and visual checks of the closure position during use and when in the incubator.



- The **vent cap** has a filter with a 0.2 µm pore size, ensuring a consistent sterile gas exchange. The hydrophobic properties of the filter minimize the risk of contamination.

Cell culture flasks

Cell culture flasks are packed in a tamper-evident, resealable mini-grip bag.



Order No.	Color code	Growth surface [cm ²]	Cap	Recommended working volume [ml]	Max. volume [ml]	Packaging bag/case
83.3910		25	Without filter	7	12.5	10/300
83.3910.002		25	With filter	7	12.5	10/300
83.3911		75	Without filter	21	55	5/100
83.3911.002		75	With filter	21	55	5/100
83.3912		175	Without filter	50	125	5/40
83.3912.002		175	With filter	50	125	5/40
83.3910.300		25	Without filter	7	12.5	10/300
83.3910.302		25	With filter	7	12.5	10/300
83.3911.300		75	Without filter	21	55	5/100
83.3911.302		75	With filter	21	55	5/100
83.3912.300		175	Without filter	50	125	5/40
83.3912.302		175	With filter	50	125	5/40
83.3910.500		25	Without filter	7	12.5	10/300
83.3910.502		25	With filter	7	12.5	10/300
83.3911.500		75	Without filter	21	55	5/100
83.3911.502		75	With filter	21	55	5/100
83.3912.500		175	Without filter	50	125	5/40
83.3912.502		175	With filter	50	125	5/40



Accessories

Order No.	Color code	Cap	Description	Packaging bag/case
83.3990.025		Without filter	for T 25	25/100 individual sterile
83.3990.075		Without filter	for T 75	25/100 individual sterile
83.3990.175		Without filter	for T 175	25/100 individual sterile

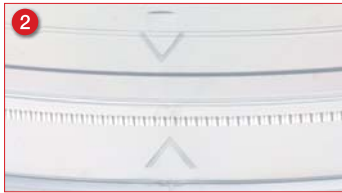
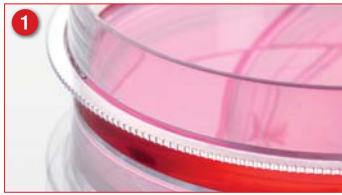

Cell culture dishes

SARSTEDT offers 35 mm, 60 mm, 100 mm, and 150 mm dishes that have been tested and certified according to the 'TC Tested' quality seal (see p. 154). The dishes are produced from high-grade transparent polystyrene with a planar growth surface of excellent transparency, allowing visual inspection of cell growth.



Product characteristics of SARSTEDT cell culture dishes

- The SUREGrip is a raised, notched ring running around the dish base for secure and convenient handling, even when picking dishes from a stack. **1** Grasping both the dish and lid at once reduces the risk of contamination.
- Clearly visible and tangible arrows on the lid and dish enable the two parts to be placed together correctly. **2**
- Ventilation cams on the lid ensure continuous gas exchange and a secure fit.
- Distinct stacking rings in the lid and base allow for secure stacking of several dishes.
- For cloning experiments, SARSTEDT offers 35 mm and 60 mm diameter dishes with a grid. **3**
- For better traceability, even after removal from the packaging, each dish is marked with the color code, lot number, and expiration date. **4**
- All cell culture dishes are available with three different growth surfaces:

-  Red = for adherent cells
-  Yellow = for difficult adherent cells
-  Green = for suspension cells

Cell culture dishes are packed in a tamper-evident, resealable mini-grip bag.

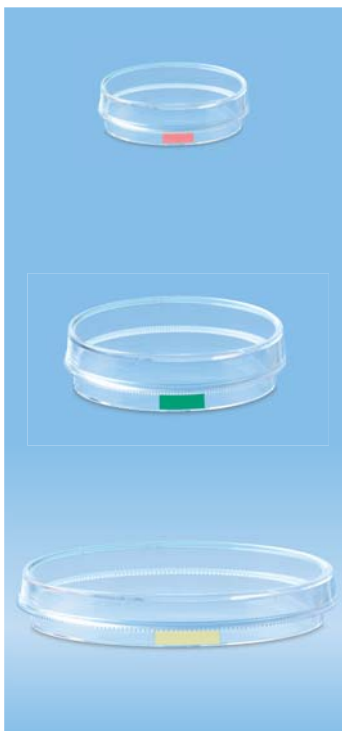

Order No.	Color code	Ø/height [mm]	Growth surface [cm ²]	Grid	Recommended working volume [ml]	Packaging bag/case
83.3900		35/10	8	Without	3	10/500
83.3900.002		35/10	8	With	3	10/500
83.3901		60/15	21	Without	5	10/500
83.3901.002		60/15	21	With	5	10/500
83.3902		100/20	58	Without	13	10/300
83.3903		150/20	152	Without	36	5/100
83.3900.300		35/10	8	Without	3	10/500
83.3901.300		60/15	21	Without	5	10/500
83.3902.300		100/20	58	Without	13	10/300
83.3903.300		150/20	152	Without	36	5/100
83.3900.500		35/10	8	Without	3	10/500
83.3901.500		60/15	21	Without	5	10/500
83.3902.500		100/20	58	Without	13	10/300

Cell scrapers for easy and complete recovery of adherent cells



SARSTEDT cell scrapers are used for the easy and gentle removal of an intact cell monolayer from cell culture flasks, dishes, plates and tubes. The smooth, flexible blade minimizes cell damage and offers a suitable and quick alternative to enzymatic detachment of the cell monolayer.

- The blades of SARSTEDT cell scrapers are made of a highly flexible, rubber-like material.
- Individually sterile packed, pyrogen-free/endotoxin-free and non-cytotoxic.
- The particularly thin blade and the ergonomic handle are available in various sizes, making them easy to use even in culture vessels that are difficult to access.
- Depending on the required application, the blade can be turned into the scraper or lifter position in order to remove the cells from the surface.

Comparison of the SARSTEDT cell scrapers with four competitor cell scrapers:

The graph shows that, in comparison with the Trypsin control, the highest cell count per ml can be detached when using the SARSTEDT cell scraper (96%). With the competitor products (A, B, C and D), the cell yields were between 62% and 84% in comparison with the Trypsin control. The quality of the cell scrapers was compared by cultivating cells under the same conditions and harvesting them using the same technique. Cell vitality, on the other hand, was around 95% for all cell scrapers.

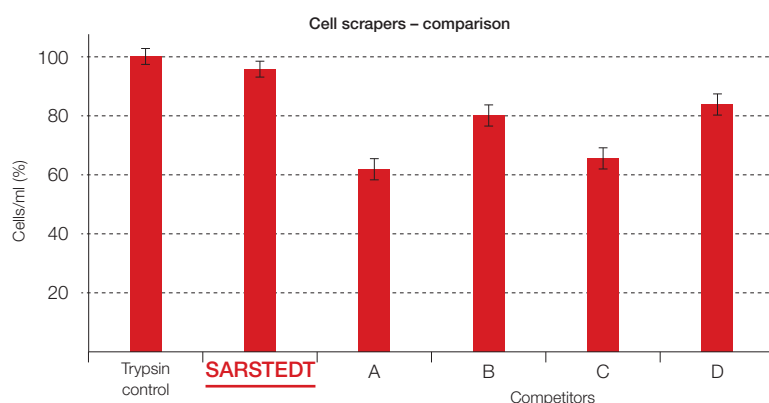

Cell scrapers for easy and complete recovery of adherent cells

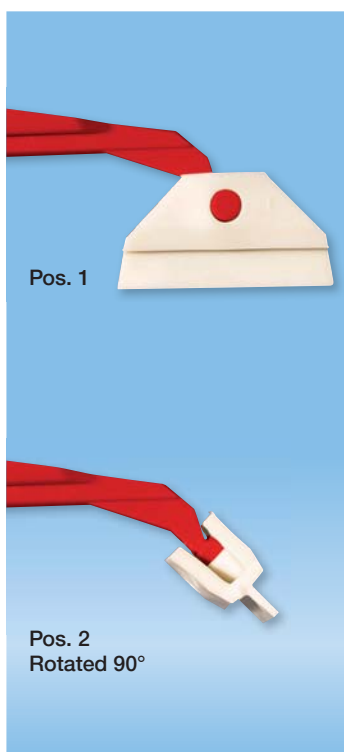

Order No.	Description	Blade length [cm]	Total scraper length [cm]	Fields of use	Case quantity
83.1832	Cell scraper with two-position blade	1.35	16.0	<ul style="list-style-type: none"> • Cell culture flasks: T-25 • 24-well, 12-well, 6-well plates • Cell culture dishes, cell culture tubes 	100
83.1830	Cell scraper with two-position blade	1.7	25.0	<ul style="list-style-type: none"> • Cell culture flasks: T-75 • Cell culture dishes: 35 x 10/60 x 15 • 6-well plates, 12-well plates 	100
83.1831	Cell scraper	3.1	39.4	<ul style="list-style-type: none"> • Cell culture flasks: T-175 • Roller bottles • Cell culture dishes 100 x 20/150 x 20 • 6-well plates 	100

Cell culture plates · Coverslips

For multiple cultivations on a medium to small scale, SARSTEDT offers cell culture plates with 6, 12, 24, 48 and 96 wells. The plates are produced from high-grade transparent polystyrene and both the individual wells and the entire plate are exceptionally flat. The highly transparent base is suitable for microscopic measurements from below. All cell culture plates are tested and certified with the 'TC tested' quality seal (see p. 154).

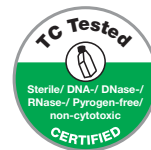



Product characteristics of SARSTEDT cell culture plates

The external dimensions of the new SARSTEDT cell culture plates meet the ANSI/SLAS (formerly SBS) standard and can be used for analyses in device holders with these dimensions. Further characteristics of the plates are as follows:



- For better traceability, even after removal from the packaging, each plate is marked with the color code, lot number, and expiration date. **1**
- To facilitate quick orientation when filling the wells, plates are labeled alphanumerically on the edge **2** and between the wells. **3**
- Free-standing wells reduce the risk of contamination when pipetting. **2** & **3**
- Non-slip side grids in the base make it easier to securely grasp the entire plate. The transparent side walls of the base enable the visual inspection of the medium. **4**
- Both air vents and condensation rings are integrated into the lid; together, they ensure consistent gas exchange while simultaneously minimizing evaporation.
- All cell culture plates are available with three different growth surfaces:

-  Red = for adherent cells
-  Yellow = for difficult adherent cells
-  Green = for suspension cells

- All cell culture plates are individually sterile wrapped. Cell culture plates with the SARSTEDT standard growth surface (red color code, flat base) are also available in packs of 5.

Highly transparent coverslips for cell cultivation

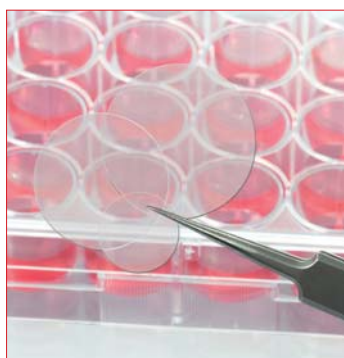

Wherever adherent cells need to be cultivated in sterile conditions, fixed, dyed and subsequently placed under a microscope on a small surface, SARSTEDT coverslips are an ideal solution. The double-sided surface treatment and the good optical quality of the modified plastic material make it easy to work with coverslips.

- Highly transparent plastic coverslips
- Available in 13 mm, 22 mm and 25 mm diameters
- Thickness: 0.255 mm
- Surface-treated on both sides (standard surface)
- Sterile, pyrogen-free/endotoxin-free and non-cytotoxic

Cell culture plates · Coverslips



Order No.	Color code	Number of wells	Base shape	Growth surface per well [cm ²]	Working volume [ml]	Packaging blister/case
83.3920		6		8.87	4	1/50
83.3920.005		6		8.87	4	5/100
83.3921		12		3.65	2	1/50
83.3921.005		12		3.65	2	5/100
83.3922		24		1.82	1	1/50
83.3922.005		24		1.82	1	5/100
83.3923		48		0.64	0.5	1/50
83.3923.005		48		0.64	0.5	5/100
83.3924		96		0.29	0.2	1/50
83.3924.005		96		0.29	0.2	5/100
83.3925		96		-	max. 0.31	1/50
83.3926		96		-	max. 0.29	1/50
83.3920.300		6		8.87	4	1/50
83.3921.300		12		3.65	2	1/50
83.3922.300		24		1.82	1	1/50
83.3923.300		48		0.64	0.5	1/50
83.3924.300		96		0.29	0.2	1/50
83.3920.500		6		8.87	4	1/50
83.3921.500		12		3.65	2	1/50
83.3922.500		24		1.82	1	1/50
83.3923.500		48		0.64	0.5	1/50
83.3924.500		96		0.29	0.2	1/50
83.3925.500		96		-	max. 0.31	1/50
83.3926.500		96		-	max. 0.29	1/50

Cell and tissue culture

Sterile coverslips can be used in various products for cell cultivation:

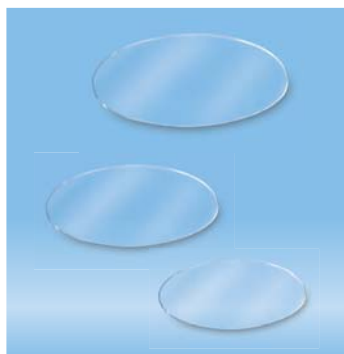

Order No.	Description	Color code	Diameter [mm]	35x10 dish	6-well plate	12-well plate	24-well plate	Packaging units/case
83.1840	Coverslips		25	✓	✓	✗	✗	200
83.1840.001	Coverslips		22	✓	✓	✗	✗	200
83.1840.002	Coverslips		13	✓	✓	✓	✓	200

SARSTEDT TC (Tissue Culture) Inserts are easy-to-use inserts for TC plates. When used in combination with our TC plates, the inserts form a 2-compartment cell culture system in which the *in vivo* situation of cells can be simulated extremely well. Our TC inserts are therefore suitable for performing many complex experiments in cell and tissue culture:

- Transport, secretion, and diffusion studies
- Migration experiments
- Cytotoxicity tests
- Co-cultures
- Transepithelial electrical resistance (TEER) measurements
- Primary cell cultures
- 3D cell cultures
- etc.



User-friendly design

- Stable casing made from highly transparent polystyrene (PS)
- Asymmetrical positioning of insert in well for easy pipetting (see Fig. 1a)
- Spacers underneath supporting arms prevent fluid from being drawn up between the insert and the well
- Scalloped upper edge of the PS body for optimal gas exchange

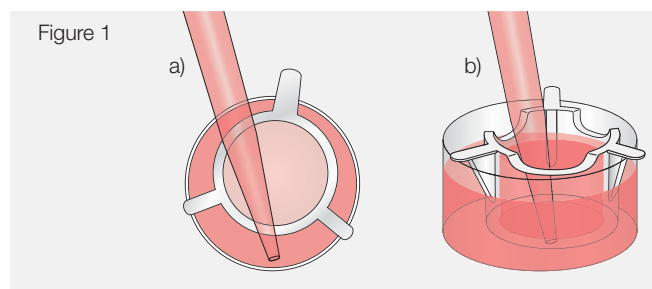

Membrane properties

- Ultra-thin, high-quality track-etched PET membrane with defined pore size of 0.4 μm , 1 μm , 3 μm , 5 μm , or 8 μm (Fig. 2a)
- Membrane available in two optical designs: transparent or translucent
- Two-sided surface treatment (TC-treated) for optimal cell adhesion
- Minimized non-specific binding of molecules thanks to the membrane's chemical properties
- High chemical resistance for a variety of cell fixing and staining methods
- Membrane can be cut out of PS body with a scalpel. The membrane stays flat for convenient, further processing (Fig. 2b)

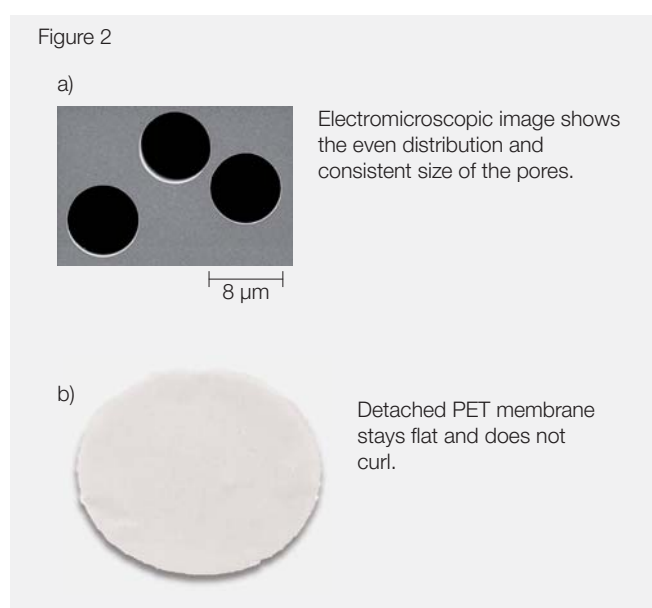

TC Inserts

- PET (polyester) membrane
- Five pore sizes (0.4 µm, 1 µm, 3 µm, 5 µm, and 8 µm) available
- Membrane available as transparent or translucent, depending on pore density
- Sterile, pyrogen-free/endotoxin-free and non-cytotoxic

Order No.	Format	Membrane material	Pore Ø [µm]	Pore density [pores/cm ²]	Optical Property	Membrane thickness [µm]	Packaging blister/box
83.3930.040	6-well	PET	0.4	1 x 10 ⁸	Translucent	12	1 / 24
83.3930.041		PET	0.4	2 x 10 ⁶	Transparent	12	1 / 24
83.3930.101		PET	1.0	2 x 10 ⁶	Transparent	11	1 / 24
83.3930.300		PET	3.0	2 x 10 ⁶	Translucent	9	1 / 24
83.3930.500		PET	5.0	6 x 10 ⁵	Translucent	10	1 / 24
83.3930.800		PET	8.0	2 x 10 ⁵	Translucent	11	1 / 24
83.3931.040	12-well	PET	0.4	1 x 10 ⁸	Translucent	12	1 / 48
83.3931.041		PET	0.4	2 x 10 ⁶	Transparent	12	1 / 48
83.3931.101		PET	1.0	2 x 10 ⁶	Transparent	11	1 / 48
83.3931.300		PET	3.0	2 x 10 ⁶	Translucent	9	1 / 48
83.3931.500		PET	5.0	6 x 10 ⁵	Translucent	10	1 / 48
83.3931.800		PET	8.0	2 x 10 ⁵	Translucent	11	1 / 48
83.3932.040	24-well	PET	0.4	1 x 10 ⁸	Translucent	12	1 / 48
83.3932.041		PET	0.4	2 x 10 ⁶	Transparent	12	1 / 48
83.3932.101		PET	1.0	2 x 10 ⁶	Transparent	11	1 / 48
83.3932.300		PET	3.0	2 x 10 ⁶	Translucent	9	1 / 48
83.3932.500		PET	5.0	6 x 10 ⁵	Translucent	10	1 / 48
83.3932.800		PET	8.0	2 x 10 ⁵	Translucent	11	1 / 48

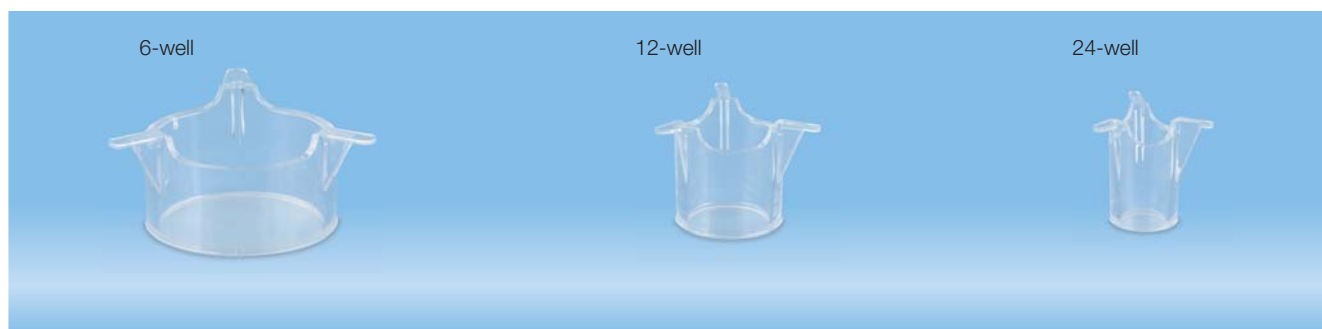

Cell and
tissue culture

The TC Inserts are compatible with the corresponding SARSTEDT TC plates*:

Order No.*	Format	Growth surface [cm ²]		Working volume [ml]	
		Well	Insert	Well	Insert
83.3920.xxx	6-well TC plate	8.87	4.5	2.4 - 4.8	1 - 4
83.3921.xxx	12-well TC plate	3.65	1.1	1.2 - 2.4	0.2 - 0.8
83.3922.xxx	24-well TC plate	1.82	0.3	0.8 - 1.6	0.1 - 0.4

The miniPERM[®] is an easy-to-handle bioreactor for the cultivation of eukaryotic cells (e.g. mammal cells, insect cells, plant cells, etc.) in high density for biomass production and for the production of cell products. The sub-division of the bioreactor into production and nutrient modules, together with rotating cultivation, enables the production of highly concentrated cell products in small volumes. Therefore, depending on the cell line, cell densities of more than 10^7 cells/ml and product concentrations of several mg/ml can be achieved. The miniPERM[®] bioreactor is a cost-effective and time-saving alternative to conventional roller bottles and fermentation systems.



Advantages of the miniPERM[®] bioreactor:

- High cell densities
- High product concentrations
- Multiple harvests
- Easy handling

The miniPERM[®] bioreactor is particularly suitable for the following applications:

- Cultivation of hybridoma cells for producing antibodies
- Cultivation of transfected cells for producing recombinant proteins or for virus production
- Cultivation of various mammal cells, insect cells, plant cells, and microorganisms
- Biomass production

Thanks to these characteristics, the miniPERM[®] bioreactor can be used for many diverse applications.

*References:

Belin, V., Rousselle, P., Production of a recombinantly expressed laminin fragment by HEK293-EBNA cells cultured in suspension in a dialysis-based bioreactor, *Protein Expression & Purification*, 48: 43-48 (2006)

Konstantinov, S. et al., Three-Dimensional Bioreactor Cultures: A Useful Dynamic Model for the Study of Cellular Interactions, *Ann. N. Y. Acad. Sci.* 1030: 103-115 (2004).

Further references and user reports are available upon request.

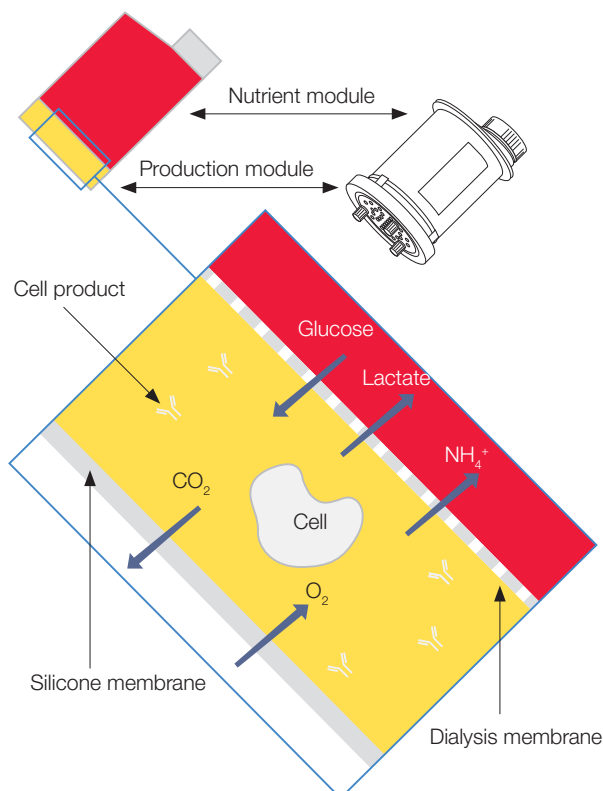

The principle

The miniPERM[®] bioreactor is subdivided into a production module and a nutrient module (two-compartment system) by a dialysis membrane.

The dialysis membrane has a cut-off size of 12.5 kDa, so that neither cells nor secreted cell products can diffuse into the nutrient module. At the same time, the exchange of nutrients and cell metabolites takes place via the dialysis membrane. Gas exchange is effected via a thin, gas-permeable silicone membrane on the outer side of the production module.

miniPERM® production modules for suspension cells

- miniPERM® classic, with 35 ml cell culture volume, is the ideal production unit for research laboratories
- miniPERM® HDC50, with 50 ml culture volume, is suitable for the production of slightly larger protein and biomass amounts
- The miniPERM® bioreactors and production modules are certified as sterile, pyrogen-free/endotoxin-free and non-cytotoxic

Order No.	Description	Packaging units/case
94.6001.059	miniPERM® classic Bioreactor, sterile	2
94.6001.055	miniPERM® classic Production module, sterile	4
94.6077.121	miniPERM® HDC 50 Bioreactor, sterile	2
94.6077.017	miniPERM® HDC 50 Production module, sterile	4

Order No.	Description	Packaging units/case
94.6001.153	Nutrient module for miniPERM®, autoclavable	4
94.6001.054	Stand for miniPERM®	4
94.6001.036	Screw cap for production module, sterile	6
94.6077.037	Screw cap for nutrient module, sterile	16
94.6077.136	Single use 2 ml Luer syringe sterile	100
94.6077.137	Single use 50 ml Luer Lock syringe, sterile	60
94.6077.138	Filling tube 5", Luer, sterile	100
94.6077.041	cellPROTECT®, sterile, 100 ml	1
94.6001.094	Start-up support kit	Quantity
	• Single use 50 ml Luer Lock syringe, sterile	8
	• Single use 2 ml Luer syringe, sterile	20
	• Filling tube 5", Luer, sterile	8
	• Luer syringe needle, 25G x 5/8", sterile	20
	• Septum port, sterile	6
	• Stand for miniPERM®	1
	• cellPROTECT®, 1 ml, sterile	1



Universal Turning Device



Order No.	Description	Packaging units/case
94.6001.061	Universal Turning Device 115/230 V	1

lumox® - Advantages at a glance

- Low autofluorescence and high light transmission compared to traditional polystyrene or glass bases
- Ideal for microscopic and automated analysis of living or immunofluorescence-stained cells
- The gas-permeable lumox® film enables optimal gas exchange due to minimal diffusion paths
- Excellent cell adhesion to surface treatment
- lumox® film is available in several cell culture product formats: dishes, plates, x-well chamber slides



lumox® dish - Gas-permeable cell culture dish

- A lumox® dish consists of a polystyrene frame and lid and a transparent, gas-permeable lumox® film base (25 µm)
- Two different growth surfaces:
 -  red = for adherent cells
 -  green = for suspension cells
- lumox® dish sizes: 35 mm and 50 mm
- Sterile, pyrogen-free/endotoxin-free, and non-cytotoxic

Order No.	Description	Surface	Ø/ height [mm]	Working volume [ml]	Packaging inner box/case
94.6077.333	lumox® dish 35		35/6	2.5	50/250
94.6077.331	lumox® dish 35		35/6	2.5	50/250
94.6077.305	lumox® dish 50		50/12	5-10	50/200
94.6077.410	lumox® dish 50		50/12	5-10	50/200

lumox® multiwell - Multiwell plate with low autofluorescence

- The plates consist of a transparent lid, a black polystyrene frame, and a 50 µm thick gas-permeable lumox® film base
- Standard TC surface for adherent cells
 -  red = for adherent cells
- Well formats: 24 wells, 96 wells and 384 wells
- Individually wrapped and sterile, pyrogen-free/endotoxin-free, and non-cytotoxic

Order No.	Description	Surface	Growth surface per well [mm²]	Working volume per well [µl]	Case quantity
94.6000.014	lumox® multiwell, 24-well		190	500 - 1500	4
94.6110.024	lumox® multiwell, 24-well		190	500 - 1500	20
94.6000.024	lumox® multiwell, 96-well		34	25 - 340	4
94.6120.096	lumox® multiwell, 96-well		34	25 - 340	20
94.6000.034	lumox® multiwell, 384-well		11	10 - 130	4
94.6130.384	lumox® multiwell, 384-well		11	10 - 130	20

x-well cell culture chambers

The x-well cell culture system is available in various slide material options for a multitude of microscopic cell culture analyses. PCA, glass, coverglass or lumox® film slides combined with a polystyrene frame form one- and multiple-chamber vessels. All products are certified as sterile, pyrogen-free/endotoxin-free and non-cytotoxic. The variety of the x-well cell culture chambers permits efficient and quick conduction of parallel test series.

- Cultivation and microscopic analyses
- Immunofluorescence analyses
- Proliferation of primary cells and cell lines
- Transfection experiments
- Histological staining
- Cytotoxicity assays

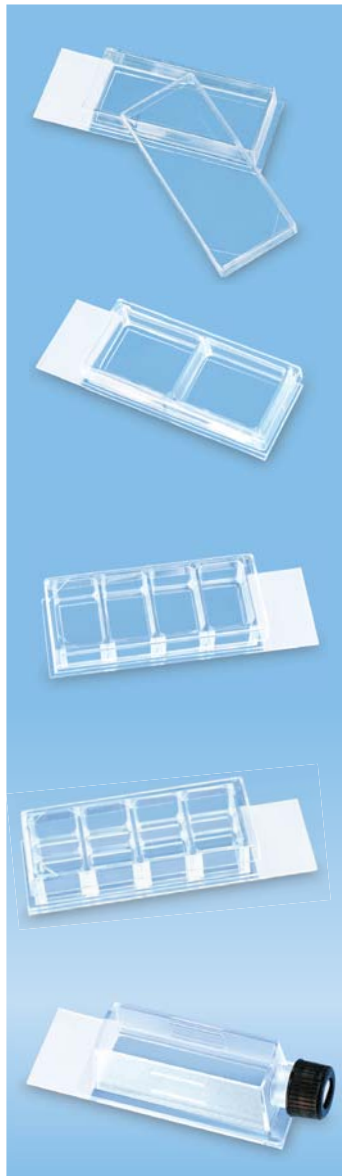

x-well PCA • detachable

The slide of the x-well PCA cell culture chamber is made of a plastic from the polyolefin family and has the advantage of a lower autofluorescence and higher chemical resistance compared with polystyrene.

- Low autofluorescence
- Slide in standard format with writing area
- Slide can be detached in one click, without leaving behind any adhesive residues
- Optimal 400-fold magnification (40x lens)

x-well glass • detachable

The standard format glass specimen slide combines ideal growth conditions for cells with outstanding optical properties. The high chemical resistance also permits the use of most fixatives and dyes.

- No autofluorescence
- Slide in standard format with writing area
- Slide can be detached in one click, without leaving behind any adhesive residues
- Optimal 400-fold magnification (40x lens)

x-well lumox® • detachable

The growth surface of the x-well lumox® specimen slide is made of gas-permeable lumox® film. Due to the outstanding optical properties of the film base, lumox® products are excellent for use in microscopy and are ideally suited for fluorescence-based cell analyses.

- Ultra-thin lumox® film (50 µm)
- Low autofluorescence
- High transparency
- Slide can be detached in one click, without leaving behind any adhesive residues
- Optimal 400-fold magnification (40x lens)

x-well coverglass

The x-well coverglass cell culture chambers have a base thickness of 170 µm and are therefore particularly well suited for high-resolution microscopy. The high chemical resistance allows for use of the most wide-ranging staining reagents.

- No autofluorescence
- Specimen slides in a short format without labeling area
- Specimen slide not detachable
- Optimal 1,000-fold magnification (100x lens)

Format	PCA	lumox®	Glass	Coverglass	Growth surface [cm ²]	Volume [ml]	Packaging tray/box
1-well	94.6140.102	94.6150.101	94.6170.102	94.6190.102	9	4	6/96
2-well	94.6140.202	94.6150.201	94.6170.202	94.6190.202	4.4	2	6/96
4-well	94.6140.402	94.6150.401	94.6170.402	94.6190.402	1.9	1	6/96
8-well	94.6140.802	94.6150.801	94.6170.802	94.6190.802	0.8	0.5	6/96
Flask	94.6140.002	-	94.6170.002	94.6190.002	9	4	6/96



flexiPERM® - Cell culture inserts

- Sub-division of slides and cell culture dishes (diameter 50 mm) into smaller cultivation units
- Made from silicone
- Reusable and autoclavable
- Highly adhesive on all smooth, flat surfaces (glass, film, plastic)
- Resistant to heat and cold
- Pyrogen-free/endotoxin-free and non-cytotoxic

Order No.	Description	Number of cultivation sections	Growth surface per section in cm ²	Fig.	Packaging quantity
94.6011.436	micro 12	12	0.3	1	5
94.6032.039	slide	8	0.9	2	5
94.6034.067	disc	4	1.8	3	5
94.6077.434	conA	1	1.1	4	5
94.6077.435	conB	1	3.1	5	5



quadriPERM® – Cell culture dish for parallel studies

- Parallel cell cultures on up to 4 slides under the same conditions
- Manufactured from high-quality polystyrene
- Sterilized with gamma irradiation
- Cell cultivation directly in the dish (suspension cells) or on coated/uncoated slides (adherent cells)
- Suitable for DIN slides
- Compatible with flexiPERM® slide and micro 12
- Easy to handle for cell cultivation, fixation and staining
- Sterile, pyrogen-free/endotoxin-free and non-cytotoxic

Order No.	Description	Growth surface per section [cm ²]	Working volume per section [ml]	Packaging bag/case
94.6077.307	quadriPERM®	24.9	approx. 10	12/48

Filtropur V vacuum filtration

Sterile vacuum filtration units and sterile bottle top filters

Efficient and economical

- **Polyethersulfone (PES) membrane filter** High-flow membrane for high throughput and low protein binding
- **Filtropur V 50 and BT 50** with 0.1 µm PES-membrane for effective prevention/removal of mycoplasmas from solutions
- **Ergonomically shaped receiver bottles** from 250 ml to 1 liter with extra capacity and improved stability
- **Easy product identification** with filter material, pore size, and item number printed on each unit and bottle top
- **Ideal for cold sterilization** of, for example, cell culture media and protein solutions
- **Sterile, pyrogen-free/endotoxin-free and non-cytotoxic**



Vacuum filtration units*

Order No.	Description	Filtration volume	Membrane diameter	Membrane/pore size	Packaging bag/case
83.3940	Filtropur V 25	250 ml	90 mm	PES/0.45 µm	1/12
83.3940.001	Filtropur V 25	250 ml	90 mm	PES/0.22 µm	1/12
83.3941	Filtropur V 50	500 ml	90 mm	PES/0.45 µm	1/12
83.3941.001	Filtropur V 50	500 ml	90 mm	PES/0.22 µm	1/12
83.3941.002	Filtropur V 50	500 ml	90 mm	PES/0.1 µm	1/12
83.3942	Filtropur V 100	1,000 ml	90 mm	PES/0.45 µm	1/12
83.3942.001	Filtropur V 100	1,000 ml	90 mm	PES/0.22 µm	1/12

*Each filtration unit has a screw cap in sterile packaging for the collection vessel.



Bottle top filter for storage vessels, max. 45 mm external diameter

Order No.	Description	Filtration volume	Membrane diameter	Membrane/pore size	Packaging bag/case
83.3940.100	Bottletop Filtropur BT 25	250 ml	90 mm	PES/0.45 µm	1/24
83.3940.101	Bottletop Filtropur BT 25	250 ml	90 mm	PES/0.22 µm	1/24
83.3941.100	Bottletop Filtropur BT 50	500 ml	90 mm	PES/0.45 µm	1/24
83.3941.101	Bottletop Filtropur BT 50	500 ml	90 mm	PES/0.22 µm	1/24
83.3941.102	Bottletop Filtropur BT 50	500 ml	90 mm	PES/0.1 µm	1/24
83.3942.100	Bottletop Filtropur BT 100	1,000 ml	90 mm	PES/0.45 µm	1/24
83.3942.101	Bottletop Filtropur BT 100	1,000 ml	90 mm	PES/0.22 µm	1/24



Filtration receiver bottles

Order No.	Description	Volume	Description	Packaging bag/case
83.3940.005	Receiver bottles for Filtropur BT 25 & BT 50	250 ml	With fitted cap	1/24
83.3941.005		500 ml	With fitted cap	1/24
83.3942.005		1,000 ml	With fitted cap	1/24

Filtropur S/Filtropur L · Filtration units

Sterile syringe filter Filtropur S for the filtration of aqueous solutions

- PES membrane for low protein binding and high flow rates
- Sterile, pyrogen-free/endotoxin-free, and non-cytotoxic
- Pre-filter option is free from binding agents with a wetting-agent free cellulose acetate membrane to ensure biocompatibility



Filtropur S 0.45 • Yellow casing, for particle removal from liquids

Order No.	Inlet / outlet connection	Filtration surface	Membrane pore size	Packaging peel pack/case
83.1826	Inlet: Luer lock, female Outlet: Luer lock, male	5.3 cm ²	PES membrane 0.45 µm	1/50

Filtropur S 0.2 • Casing: dark blue/clear, for sterile filtration

Order No.	Inlet / outlet connection	Filtration surface	Membrane pore size	Packaging peel pack/case
83.1826.001	Inlet: Luer lock, female Outlet: Luer lock, male	5.3 cm ²	PES membrane 0.2 µm	1/50

Filtropur S plus 0.2 • Casing: blue/opaque, with integrated glass fiber prefilter, for the sterile filtration of difficult-to-filter liquids (e.g. serum)

Order No.	Inlet / outlet connection	Filtration surface	Membrane pore size	Packaging peel pack/case
83.1826.102	Inlet: Luer lock, female Outlet: Luer lock, male	5.3 cm ²	CA/GF membrane 0.2 µm	1/50

Pressure filtration system Filtropur L with integrated prefilter for the sterile filtration of media, serums, buffers and other aqueous solutions

- Filtration range: 100 ml to 10 l
- Sterile, pyrogen-free/endotoxin-free, and non-cytotoxic



Filtropur L 0.2 S with integrated glass fiber prefilter for use with pressure pumps (e.g. membrane pumps) or peristaltic pumps (e.g. hose pumps)

Order No.	Inlet	Membrane pore size	Packaging bag/case
83.1827	Tube connector (6-12 mm stepped)	CA/GF membrane 0.2 µm	1/50

Filtropur L 0.2 LS with integrated glass fiber prefilter for use with pressure pumps (e.g. membrane pumps) or peristaltic pumps (e.g. hose pumps)

Order No.	Inlet	Membrane pore size	Packaging bag/case
83.1827.001	Luer lock	CA/GF membrane 0.2 µm	1/50

Membrane pump with tube set, 115 V, stainless steel sinker, tube adapter for Filtropur L 0.2 LS

Order No.	Scope of delivery	Packaging units/case
83.1850.600	2.5 m silicone hose 5 multi-function adapters 1 stainless steel sinker	1



Tissue culture tubes, sterile, TC quality, transparent polystyrene

Screw cap polystyrene tubes with standard TC surface are particularly suitable for:

- Cultivation of smaller cell populations
- Cultivation of suspension or monolayer cultures
- Storage or transport of cell materials
- The screw cap allows an open or closed growth environment for cell cultures

Order No.	Volume in ml	Length/Ø in mm	Description	Packaging
83.9923.945	15	125/16	Round base	5/bag 1,000/case
83.9923.943	12	99/16	Round base	
83.9923.929	10	97/16	Conical with skirted base	



Centrifuge tubes with conical base, assembled red screw cap, with graduations and writing space

- Transparent PP enables visual inspection of the sample material
- Sterile, pyrogen-free/endotoxin-free and non-cytotoxic

Order No.	Volume in ml	Length/Ø in mm	Description	Packaging
62.559.101	50	115/28	Conical base with skirt	25/bag 300/case
62.547.100	50	114/28	Conical base	25/Styrofoam rack 200/case
62.547.205	50	114/28	Conical base	25/bag 250/case
62.554.100	15	120/17	Conical base	50/Styrofoam rack 500/case
62.554.205	15	120/17	Conical base	50/bag 500/case



Tubes with assembled two-position ventilation cap, sterile

- Position 1: Cap lightly engaged → ventilated
 Position 2: Cap firmly engaged → sealed

Order No.	Volume (ml)	Length/Ø (mm)	Description	Packaging bag/case
55.526.006 PP 55.476.013 PS	5	75/12	Without print	25/1,000
62.526.028 PP 62.476.028 PS	5	75/12	With printed graduations	Individually wrapped 500/case
62.515.006 PP	13	100/16	With printed graduations	25/500
62.515.028 PP	13	100/16	With printed graduations	Individually wrapped 500/case

PS = transparent polystyrene, PP = polypropylene



Swabs are used to collect and transport bacteriological, serological and cytological samples. Our swabs are suitable for use both on intact skin and in natural body orifices. They can also be used in the food industry within the scope of hygiene controls and for sample collection from various surfaces.

We produce Petri dishes made from high-quality transparent polystyrene for the cultivation of microorganisms. Due to their high shape retention, they are perfect for use in automated plate filling systems and are easily stacked.

Our gas samplers are used for the accurate volume collection of gaseous samples for emission and immission measurements, tracing pollutants in the workplace – TLV level controls – and for examining process gases. The gas sampler design ensures reliable and physically correct measurement of the sample volume.

Our GS 100 Microbial Air Sampler collects ambient air samples for microbiological testing. Based on the Anderson Airsampler Principle, it draws in the ambient air over a nozzle plate. Without going through filters or nutrient solutions, particles and germs are deposited on an underlying Petri dish with nutrient solution.



Microbiology

Swabs	174
Petri dishes	175
DishRack, inoculation loops/needles/spreaders	176
Petri dish organization & transfer system	177

Environmental technology

Gas samplers	178
Microbial air samplers	179



Neutral swabs, sterile

- For use on intact skin and in natural body orifices
- Suitable for transport
- Short and long swabs available
- Sterile, packed in PE bags/inner boxes

Order No.	Ø/tube length (mm)	Stem material/length (mm)	Swab material	Packaging
80.625	16.5/101	Polystyrene/90	Viscose	500/bag 500/case
80.1301.500	13/145	Polystyrene/150	Viscose	500/inner box 2,000/case
80.1303.500	13/145	Aluminium/150	Viscose	500/inner box 2,000/case



Swabs with transport medium

- Transport tubes and separate swabs, individually wrapped, sterile, in practical peel-pack packaging
- Amies transport medium with or without charcoal
- Sensitive pathogens safely survive several days of transport
- Tested according to the CLSI standard method M40-A2
- Suitable for aerobes and anaerobes
- Swab stem material available in aluminium or plastic

Swab with Amies transport medium, sterile

Order No.	Ø/tube length (mm)	Stem material/length (mm)	Swab material	Packaging
80.1361.500	13/145	Polystyrene/150	Viscose	100/inner box 600/case
80.1363.500	13/145	Aluminium/150	Viscose	100/inner box 600/case

Swab with Amies medium and charcoal, sterile

Order No.	Ø/tube length (mm)	Stem material/length (mm)	Swab material	Packaging
80.1362.500	13/145	Polystyrene/150	Viscose	100/inner box 600/case
80.1366.500	13/145	Aluminium/150	Viscose	100/inner box 600/case

Petri dishes for bacteriology

- Made from transparent polystyrene, heat-resistant to approx. 80°C, easy to stack
- Ideal for use in automated plate filling machines

Order No.	Diameter/height (mm)	Ventilation cams	Packaging bag/case
82.1184.500	150/20 (gamma-sterile)	With	10/100
82.1472	92/16	Without	20/480
82.1473	92/16	With	20/480
82.1472.001	92/16 (gamma-sterile)	Without	20/480
82.1473.001	92/16 (gamma-sterile)	With	20/480
82.1194.500	60/15 (gamma-sterile)	With	20/500
82.1135.500	35/10 (gamma-sterile)	With	20/500

Petri dish, round, two compartments

Order No.	Diameter/height (mm)	Ventilation cams	Packaging bag/case
82.1195	92/16	With	20/480

Colored Petri dishes with ventilation cams

Order No.	Diameter/height (mm)	Color	Packaging bag/case
82.1473.020	92/16	Red 	20/480
82.1473.040	92/16	Yellow 	20/480
82.1473.060	92/16	Blue 	20/480
82.1473.080	92/16	Green 	20/480

Petri dish, square

Order No.	L x W x H in mm	Ventilation cams	Packaging bag/case
82.9923.422	100 x 100 x 20 gamma-sterile	Without	4/160

Practical stand for 92/16 Petri dishes see DishRack, page 176.

DishRack · Inoculation loops/needle/spreader



Polycarbonate DishRack 50 for up to 52 Petri dishes with 92 mm diameter

Order No.	Color	Height (mm)	Packaging units/case
93.1647	Neutral 	240	1
93.1647.001	Red 	240	1
93.1647.002	Yellow 	240	1
93.1647.003	Blue 	240	1
93.1647.004	Green 	240	1

Replacement flexible silicone strips, available under **Order No. 93.1647.050**

Polycarbonate DishRack 80 for up to 88 Petri dishes with 92 mm diameter

Order No.	Color	Height in mm	Packaging units/case
93.1646	Neutral 	360	1
93.1646.001	Red 	360	1
93.1646.002	Yellow 	360	1
93.1646.003	Blue 	360	1
93.1646.004	Green 	360	1

Replacement flexible silicone strips, available under **Order No. 93.1646.080**

In principle, the DishRacks may be autoclaved. However, repeated autoclaving (3x) may cause stress cracks on the riveted joints of the racks. These stress cracks do not affect the stability of the racks.



Polystyrene inoculation loops, needles, and spreaders

- Time-saving when processing large test series
- Convenient handling
- Safe - no pathogenic aerosols or cross-contamination
- Gamma-sterile

Order No.	Description	Color	Packaging
86.1562.010	10 µl loop	Blue 	10/peel-pack 1,000/case
86.1562.050	10 µl loop	Blue 	48/peel-pack 1,920/case
86.1567.010	1 µl loop	White 	10/peel-pack 1,000/case
86.1567.050	1 µl loop	White 	48/peel-pack 1,920/case
86.1568.010	Needle	Orange 	10/peel-pack 1,000/case
86.1568.050	Needle	Orange 	50/peel-pack 2,000/case
86.1569.001	Inoculation spreader	Blue 	1/bag 500/case
86.1569.005	Inoculation spreader	Blue 	4/peel-pack 500/case

Petri dish organization & transfer system POS 720 • PTS

POS 720 and PTS provide automation in microbiological laboratories with medium to high sample volumes. More than 700 Petri dishes are labeled per hour, stacked in sets, and transported to workstations in a fully automatic process. Labeling errors are reduced and processes are simplified and consistent, improving quality and competitiveness.

- Individual requirements for dish sets at each workstation
- POS 720 - Selects agar dishes from supply, labels, and stacks into plate sets
- PTS - Transports dish sets to workstations

PTS Petri Dish Transfer System

The PTS Petri Dish Transfer System transports the dish stacks, pre-sorted by the POS 720, to individual workstations. All sample preparation procedures required for the analysis can be carried out at the integrated workstation, so that the starting materials do not have to be handled multiple times. This enables a clear increase in efficiency.

Example layout for PTS with four workstations (AP1-AP4)

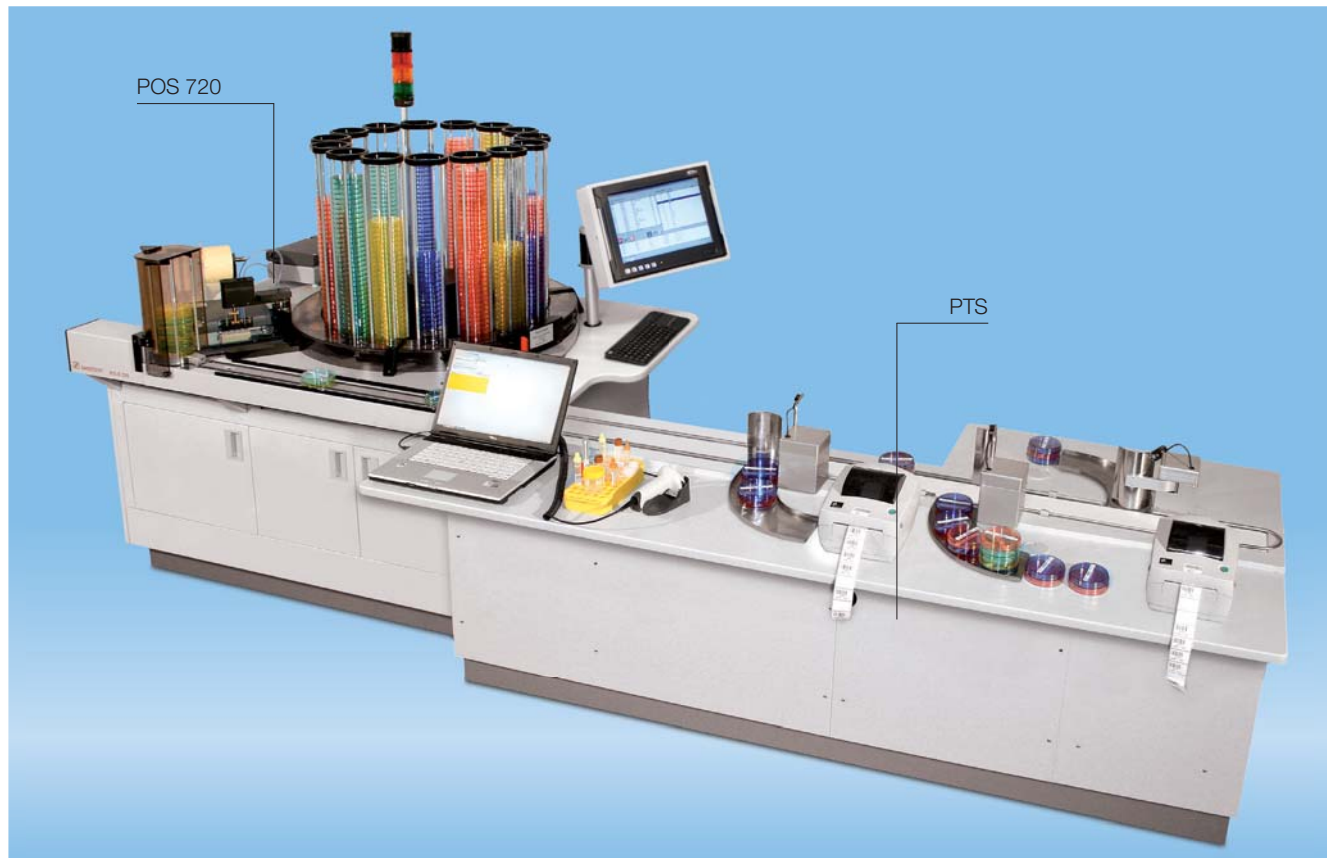
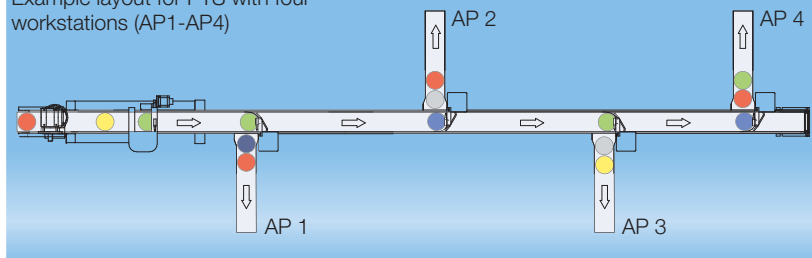

Gas sampler

Our gas samplers are used for collecting accurate volumes of samples for emission and immission measurements, e.g. for tracing pollutants in the workplace and for examining process gases. Air quality control and documentation is increasingly important in many work areas in hospitals, as well as in the pharmaceutical, cosmetic and food industries.



Order No.	Description	Packaging/item
90.170.300	GS 312, Gas sampler, incl. mains adapter GN 100-240/12 V	1
90.170.310	GS 212, Gas sampler (without mains adapter)	1
90.170.185	Mains adapter GN 100-240/12 V for GS 212	1



90.170.350	GS 301, Gas sampler, incl. mains adapter GN 100-240/12 V, without sample changer	1
92.170.352	Sampler changer type B/G for GS 301, for tubes 7 x 125 mm	1
92.170.353	Sampler changer type N for GS 301, for tubes 6 x 70 mm	1
92.170.354	Sampler changer type ATD for GS 301, for tubes 6 x 89 mm	1
92.170.356	Sampler changer type W for GS 301	1
90.170.180	GB 12, battery pack, 230 V/12 V	1

Washing bottles and accessories on request.

Microbial air samplers

- Anderson Airsampler Principle
- Individually adjustable expiry parameters
- Battery or mains supply

The DESAGA GS 100 Microbial Air Sampler collects ambient air samples for microbiological testing. Based on the Anderson Airsampler Principle, it draws in ambient air over a nozzle plate. A microprocessor controls and inspects the sample collection, and the thermal mass flow meter accurately regulates the flow. The design of the inlet results in an intake speed of approx. 0.4 m/sec, whereby the air flow is set to 100 l/min in the factory. Without going through filters or nutrient solutions, particles and germs are deposited on an underlying standard Petri dish with nutrient medium. The cultivation of the colony-forming units can then take place directly in this dish. The germination number is determined using conventional methods. The collection head can be autoclaved, and the housing can be cleaned using conventional disinfectants.

Before measurement, the measurement parameters are entered via the keypad. Five different programs can be stored for sampling, consisting of feed volume and start delay. This data can be called up at any time, inspected and changed via the 2-line LCD display.

In the event of mobile use, the battery can supply power for approx. 5-6 hours. The included mains adapter can be used to recharge the battery and for direct operation from the power outlet.



Order No.	Description	Packaging/item
90.170.370	GS 100, microbial sampler, 230 V incl. collection head	1
92.170.375	Collection head for GS100, aluminium, 400 holes	1
92.170.390	Transport case for GS 100	1

Instruction manual on request.

Technical data

Measurement principle:	Thermal mass flow meter
Measurement programs:	5 collection methods, storable
Intake speed:	0.4 m/sec
Feed rate:	100 l/min
Feed volume:	10 – 9,990 l
Start delay:	0:00 – 59:59 min
Suitable Petri dishes:	Standard Petri dishes, diameter 90 mm (e.g. item no 82.1473)
Dimensions (WxDxH):	200 x 170 x 125 mm
Weight:	2.3 kg
Power supply:	Battery pack, operating capacity 5-6 hours, 240/15 Volt mains-powered operation with charging adapter 20-80% rel. humidity
Working area:	0 - +50°C



For 40 years, we have manufactured high-quality disposable cuvettes from polystyrene (PS) and acrylic (PMMA). The cuvettes are available in 2x optical semi-micro and 4x optical formats for 90° angle fluorescence measurements.

Products for sample preparation, labeling and disposal complete our laboratory range. Our convenient stirring rods can be used to mix samples and solutions. Our waterproof and fast-drying felt markers are used to permanently mark plastic tubes and reaction tubes. Our light, square weighing dishes are the perfect choice for weighing liquid, solid and powder substances with ease.

Our disposal bags are used to collect and dispose of used laboratory and hospital products and are made from a 50 µm-thick polypropylene film. In addition to various sizes, colored bags and bags with 'Bio Hazard' printed on them are also available. The volume of the bags ranges from 2 l to 80 l.



Cuvettes	182 - 183
Stirring rods · Felt markers · Weighing dishes	184
Disposal bags	185

Standard cuvettes

Since the 1970s, SARSTEDT has manufactured high-quality disposable cuvettes from polystyrene (PS) and acrylic (PMMA). To capture the increasingly important UV range to 220 nm, the product range also includes UV-transparent disposable cuvettes (see page 183).

Polystyrene can be used from the visual range to the UV range to **330 nm** thanks to its optical properties. At 334 nm, for example, it has a spectral transmission of approx. 70-80%.

Acrylic cuvettes on the other hand, are characterized by a high level of transparency in the UV range and can be used to approximately **300 nm**. The spectral transmission at 334 nm is approx. 97%.

Transmission depending on the wavelength

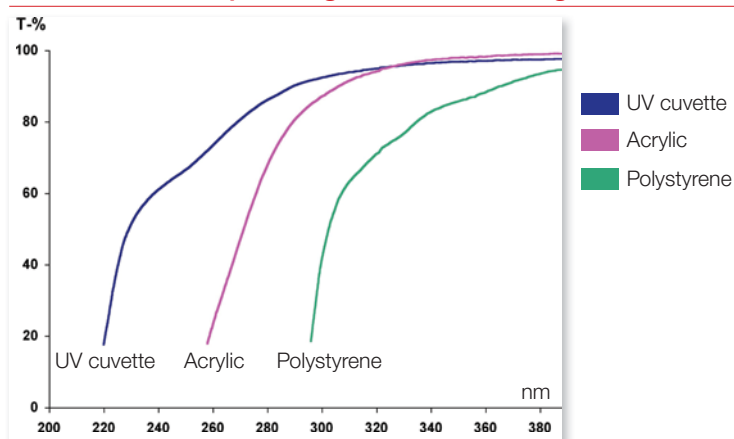

Wavelength (nm)	Transmission (T) in %		
	UV	Acrylic	Polystyrene
260	73%	23%	0%
280	86%	68%	0%
313	94%	93%	66%
334	96%	97%	79%
366	97%	98%	90%
405	98%	99%	95%
560	98%	99%	96%

Method: measured against air with distilled water, light path: 10 mm.



Semi-micro cuvette 10 x 4 mm, light path: 10 mm, 2 sides optical

Order No.	Height in mm	Material	Packaging	Packaging units/case
67.742	45	Polystyrene	100/Styrofoam rack, packed by mold cavity number	2,000
67.746	45	Polystyrene	Loose, 500/bag	2,000
67.740	45	Acrylic (PMMA)	100/Styrofoam rack, packed by mold cavity number	2,000

Cuvette 10 x 10 mm, light path: 10 mm, 2 sides optical

Order No.	Height in mm	Material	Packaging	Packaging units/case
67.741	45	Polystyrene	100/Styrofoam rack, packed by mold cavity number	2,000
67.745	45	Polystyrene	Loose, 500/bag	2,000
67.738	45	Acrylic (PMMA)	100/Styrofoam rack, packed by mold cavity number	2,000

Cuvette for fluorescence measurements, light path: 10 mm, all 4 sides optical

Order No.	Height in mm	Material	Packaging	Packaging units/case
67.754	45	Polystyrene	100/Styrofoam rack, packed by mold cavity number	2,000
67.755	45	Acrylic (PMMA)	100/Styrofoam rack, packed by mold cavity number	2,000

PS = polystyrene, PMMA = Polymethyl methacrylate

UV micro cuvette

The plastic material of the UV cuvette enables measurements in the UV range at wavelengths of **220 nm upwards**. Disposable UV-transparent cuvettes prevent contamination caused by repeated washing of quartz cuvettes. In addition to non-certified UV cuvettes, certified UV cuvettes are also available individually sealed with a cap.

All UV cuvettes are packed in Styrofoam racks to avoid scratches.

Typical applications and product features

- Photometric quantification of nucleic acids at 260 nm and of proteins at 280 nm
- Minimal UV absorption for DNA, RNA and protein quantification
- Minimum sample volume: 50 µl
- Suitable for photometers with a light center height (LCH) of 8.5 mm and 15 mm: Eppendorf Biophotometer, ThermoSpectronic, Perkin Elmer, Bio-Rad, Analytik Jena, etc.
- DNA/RNase/protein-free UV cuvettes sealed with individual caps are available as an option for safe sample storage and prevention of contamination



UV micro cuvette

Order No.	Height in mm	LCH	Packaging
67.758	45	8.5 mm	100/Styrofoam rack, 400/case
67.758.001	45	8.5 mm	100/styrofoam rack, 400/case (individually sealed with cap, certified DNA-/RNase-/protein-free)
67.759	45	15 mm	100/Styrofoam rack, 400/case
67.759.001	45	15 mm	100/styrofoam rack, 400/case (individually sealed with cap, certified DNA-/RNase-/protein-free)

Cuvette 10x10 mm with round opening, optical path: 10 mm, 2 sides optical

Order No.	Height in mm	Material	Packaging	Packaging units/case
67.743	96	Polystyrene	100/Styrofoam rack, packed by mold cavity number	1,000
67.749	55	Polystyrene	100/Styrofoam rack, packed by mold cavity number	2,000

Push caps for cuvettes with round opening

Order No.	Suitable for cuvette	Packaging bag/case
65.803.300	Order No.: 67.743	1,000/5,000
65.793.300	Order No.: 67.749	1,000/5,000

Round cuvette for LKB analyzer (used specifically for sample preparation)

Order No.	Height/Ø in mm	Material	Packaging	Packaging units/case
68.752	51/12	Polypropylene	1,000/bag	5,000



Stirring rod

- Useful for many applications like mixing of samples and solutions or removing sediment from the wall of the tube
- The short rod is particularly suitable for mixing in cuvettes

Order No.	Material	Length/Ø in mm	Packaging bag/case
81.970	PP	120/3	1,000/10,000
81.971	HD-PE	64/3	1,000/10,000

Dispenser box for long stirring rods

Each case contains one practical dispenser box. The dispenser box can be filled with up to 500 stirring rods.



Lumocolor felt-tip pen, permanent

For labeling plastic tubes and reaction tubes

- Clean, smudge-proof labeling
- Waterproof
- Quick drying

Order No.	Color	Packaging
95.953	Blue	10/cardboard box
95.954	Black	
95.955	Green	
95.956	Red	

Felt-tip pen, alcohol-resistant

- Permanent marking of a large number of surfaces used in laboratories (e.g. plastic)
- Particularly suited for uses where alcohol is used as a disinfectant (e.g. cell culture)
- Suitable for dry, damp and cold surfaces

Order No.	Color	Packaging
95.950	Black	10/cardboard box



Weighing trays

- Square, lightweight weighing trays for easy weighing
- Suitable for liquids, solids and powders
- Rounded corners for easy emptying

Order No.	Material	Dimensions in mm	Volume in ml	Packaging units/case
71.9923.211	PVC	35 x 35	5	2,000
71.9923.212	PVC	72 x 72	70	2,000
71.9923.210	PS	128 x 128	250	1,000

PP = Polypropylene, PS = Polystyrene, HD-PE = High Density Polyethylene, PVC = Polyvinyl chloride



Suitable for waste sterilization of disposable materials

SARSTEDT disposal bags are used to collect and dispose of used consumables from the laboratory and hospital. A high level of tear and perforation resistance is achieved using a 50 µm thick polypropylene bag with stable, wide base seam. Due to the risk of injury, however, sharp or pointed objects should never be placed in the disposal bags.

The SARSTEDT disposal bags are suitable for steam sterilization in autoclaves at 121°C⁽¹⁾ or 134°C⁽²⁾. In order to achieve full steam sterilization, the disposal bag must always be autoclaved without being sealed.

In addition to various sizes, colored bags and variants with 'Bio Hazard' printed on them are also available.

- Strong 50 µm thick polypropylene
- Reduction in the waste volume
- Can be autoclaved at 121°C⁽¹⁾ or 134°C⁽²⁾

Order No.	Opening dimension x length (mm)	Capacity**	Bag color		Bag print		Print color		Packaging bag/case
			Natural	Yellow	Yes	No	Red	Blue	
86.1197*	200 x 300 ⁽¹⁾	2 liters	•			•			100/1,000
86.1198	300 x 500 ⁽²⁾	7 liters	•			•			50/500
86.1201	300 x 500 ⁽¹⁾	7 liters	•		•		•		50/500
86.1201.103	300 x 500 ⁽²⁾	7 liters		•	•			•	50/500
86.1199	400 x 780 ⁽²⁾	24 liters	•			•			50/250
86.1202	400 x 780 ⁽¹⁾	24 liters	•		•		•		50/250
86.1202.103	400 x 780 ⁽²⁾	24 liters		•	•			•	50/250
86.1200	600 x 780 ⁽²⁾	40 liters	•			•			50/250
86.1203	600 x 780 ⁽¹⁾	40 liters	•		•		•		50/250
86.1203.103	600 x 780 ⁽²⁾	40 liters		•	•			•	50/250
86.1204	700 x 1,120 ⁽²⁾	80 liters	•			•			50/150
86.1206.103	700 x 1,120 ⁽²⁾	80 liters		•	•			•	50/150

* Disposal bag for table racks in practical dispenser box (100 units/dispenser pack).

** Can still be sealed after autoclaving.



Table rack for disposal bag

Steel wire rack coated with epoxy resin

Order No.: 95.1297

1 rack, includes a dispenser box of bags (order no. 86.1197)



The clinical care product segment is focused on the fields of regional anesthesia and urine drainage systems.

Our many years of experience in the development and the quality of the production of billions of blood collection safety-needles has been transferred to the manufacture of regional anesthesia safety-needles.

The identification of the correct puncture site is essential for a high success rate in peripheral nerve blocks. The REGANESTH® unoplex needle has been developed for ultrasound-guided peripheral nerve blocks. The *Rhombus Cut* ultrasound marker offers impressively high echogenicity, enabling excellent visibility of the needle tip on the ultrasound image.

For patient-oriented care of incontinence and catheter patients, urine drainage systems and accessories to ensure safe and hygienic patient care are available.

The UM 500 enables precise, safe urine volume measurement and drainage. The measuring system is characterized by precise, quick reading using the clear scale and multiple hydrophobic ventilation with a bacterial filter.

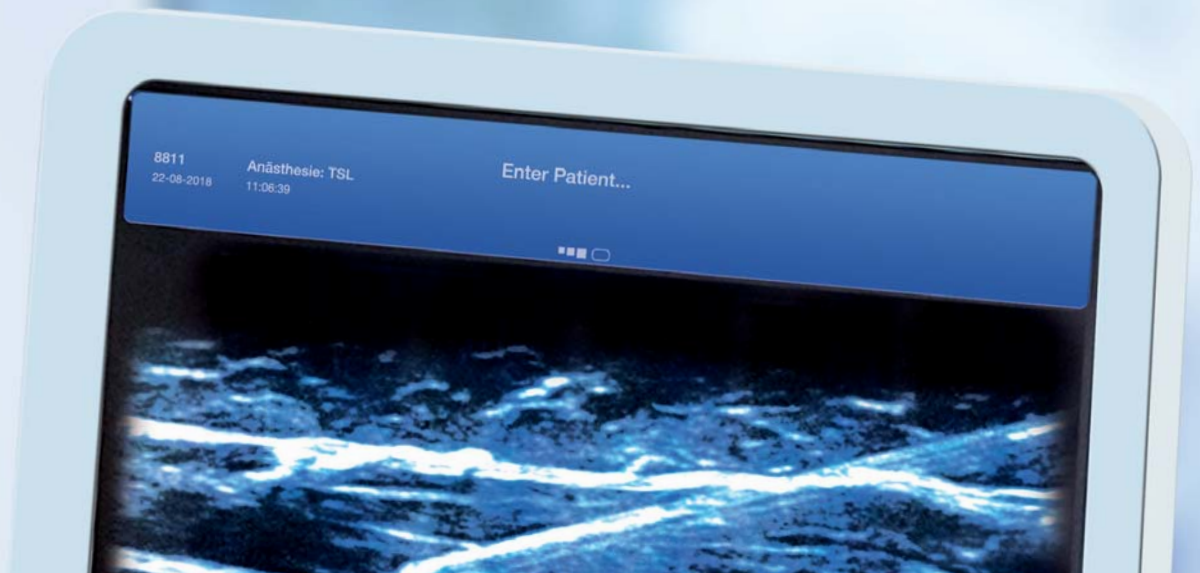

Urine drainage systems	
UD <i>3plus</i> urine drainage system · UD 3 TUR-BAG	188
UM 500 urine measuring system	189
Urine and secretion bags · Universal hooks	190 - 191
Urine leg bag	192
Velcro bands · UroStretch	193
Pressure infusion cuffs · Transfusion system	
Pressure infusion cuffs	194 - 195
Transfusion systems	196
HAEM-o-TRANS auto-transfusion	197
Regional anesthesia	
Spinal anesthesia	199
Epidural anesthesia	200
Plexus anesthesia	201
Warming	
SAHARA-III	202
SAHARA-TSC	203
Syringe labeling	
ISO/perfusor labels · Label dispenser	204
Other	
Other · Accessories for blood bags · Navel clamp	205



UD 3plus closed urine drainage system with 2 liter drainage valve bag

- Universal stepped connector with integrated sampling point
- Drop chamber with optimized, bacteria-proof ventilation and membrane one-way valve
- Universal holder for secure fastening to all standard patient beds, multiple use possible
- Ventilated 2 liter urine collection bag with printed fine measurement range
- One-handed drainage valve with plug-in slot

Order No.	Volume	Tube length	Description	Packaging units/case
74.5330	2.0 liters	100 cm	With holder, sterile	25
74.5330.010	2.0 liters	120 cm	With holder, sterile	25
74.5335	2.0 liters	100 cm	Without holder, sterile	20
74.5335.010	2.0 liters	120 cm	Without holder, sterile	20
74.5350	Universal holder for secure fastening to all standard patient beds			15



UD 3 TUR-BAG closed urine drainage system for bladder irrigation

- Large-lumen, kink-resistant 100 cm long drainage tube
- Drop chamber with hydrophobic system ventilation for optimal irrigation control
- 4-liter capacity
- One-handed drainage valve for quick, drip-free bag emptying

Order No.	Volume	Description	Packaging units/case
74.5340	4.0 liters	UD 3 TUR-BAG with pump ball, sterile	20
74.5340.001	4.0 liters	UD 3 TUR-BAG without pump ball, sterile	25

Urine measuring system

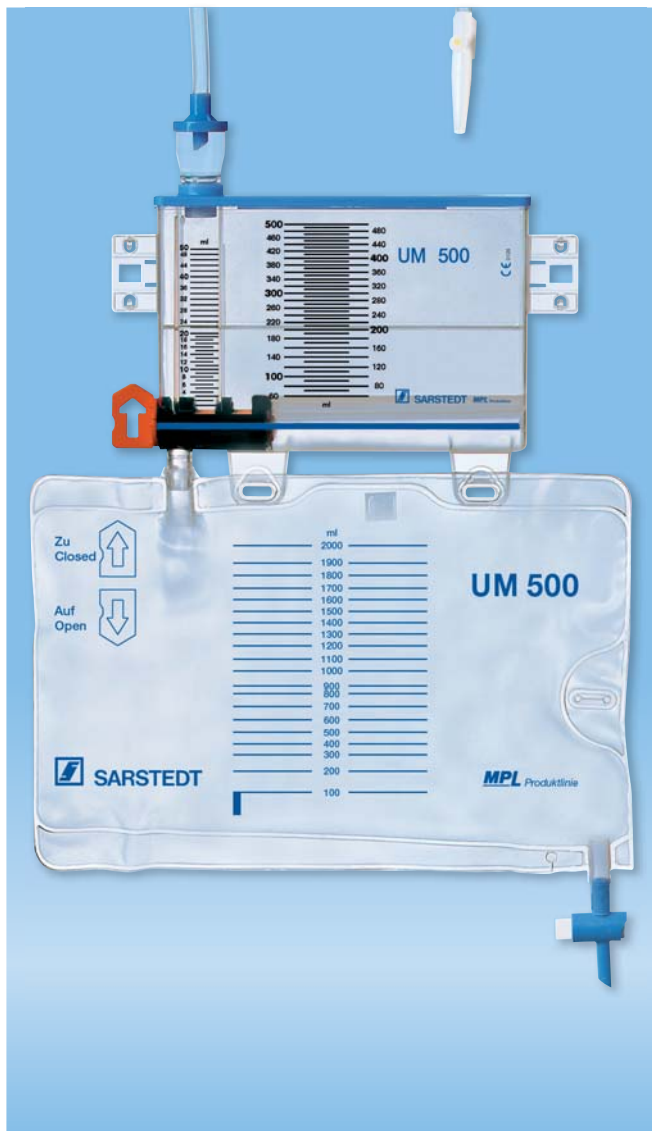

UM 500 urine measuring system

500 ml measuring chamber with integrated/ventilated drop chamber and anti-reflux valve, overflow protection, fine measurement range, central drainage valve and chamber ventilation.

- Choice between permanent/exchange bag with drainage valve or exchange bag
- Individual fixation options with retaining straps or special hooks for system rails
- Individually packed, sterile

Order No.	Volume	Description	Packaging units/case
74.5610.100	2,000 ml permanent bag	UM 500 with hook attachment for system rails	15
74.5610.200	2,000 ml permanent bag	UM 500 with retaining strap attachment	15
74.5620.200	1,800 ml exchange bag	UM 500 with retaining strap attachment	15
74.5630.200	3,000 ml exchange bag	UM 500 with retaining strap attachment	15
74.5622.005	1,800 ml	Exchange bag 1,800 ml for UM 500	100
74.5624.005	3,000 ml	Exchange bag 3,000 ml for UM 500	100
74.5650.010		Attachment hooks for wide bed rails	150



Rapid emptying

The combination of a large-lumen, smooth rotary valve and optimal pressure equalization in the system (bacteria-proof ventilation of the drop chamber, measuring chamber and collection bag) ensures rapid emptying of the measuring chamber.

Easy to read

The precise, easy-to-read scale allows the smallest amounts to be established to the closest milliliter. The total measuring volume of 500 ml and the clear, visible scale mean that figures can be exact, even at high clearance rates.

Hygienic safety

The integrated drop chamber with bacteria-proof ventilation and a membrane anti-reflux valve, together with an additional anti-reflux barrier in the collection bag, ensure hygienic safety and prevent ascending bacterial migration.

Urine and secretion bags

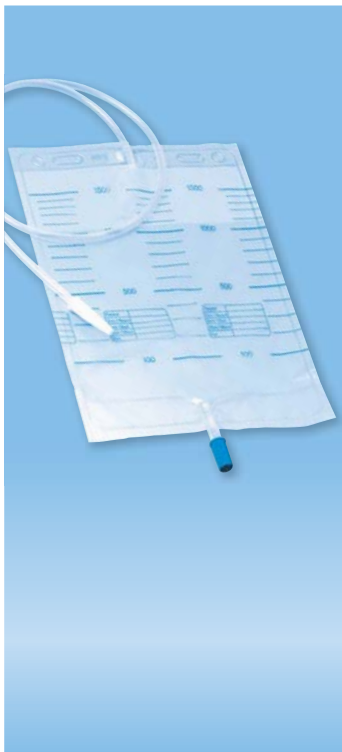

Urine and secretion bag with anti-reflux valve and bottom drain valve

- Universal stepped connector
- Transition tube, 90 cm long, inner diameter 5 mm
- Anti-reflux valve
- Push/pull drainage valve

Order No.	Volume	Description	Packaging units/case
74.5210.101	1.5 liters	Non-sterile	150
74.5210.001	1.5 liters	ETO* treated	150
74.5220.101	2.0 liters	Non-sterile	150
74.5220.001	2.0 liters	ETO* treated	150
74.5220.005	2.0 liters	Sterile, individually wrapped	100

* Ethylene oxide



D-2 urine drainage bag 2.0 liters

- Stepped connector with integrated sampling point
- Anti-reflux valve
- Bag ventilation
- One-handed drainage valve

Order No.	Volume	Description	Packaging units/case
74.5455.005	2.0 liters	D-2 urine drainage bag without hook, individually packaged, sterile	50

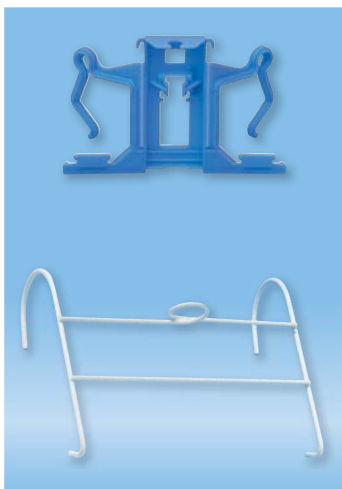

Universal hooks for urine and secretion bags

Order No.	Description	Packaging units/case
74.5350	Plastic, fits all SARSTEDT urine and secretion bags	15
74.5760	Metal	50

Urine and secretion bags



Urine and secretion bag with anti-reflux valve

- Universal stepped connector
- Transition tube, 90 cm long, inner diameter 5 mm
- Anti-reflux valve
- Tear-away edge for disposal

Order No.	Volume	Description	Packaging units/case
74.5203.101	1.5 liters	Non-sterile	200
74.5203.001	1.5 liters	ETO* treated	200
74.5203.005	1.5 liters	Sterile, individually wrapped	100
74.5204.101	2.0 liters	Non-sterile	200
74.5204.001	2.0 liters	ETO* treated	200
74.5204.005	2.0 liters	Sterile, individually wrapped	100



Secretion bag

- Universal stepped connector
- Transition tube, 90 cm long, inner diameter 5 mm
- Tear-away edge for disposal

Order No.	Volume	Description	Packaging units/case
74.5201.101	1.5 liters	Non-sterile	200
74.5201.001	1.5 liters	ETO* treated	200
74.5201.005	1.5 liters	Sterile, individually wrapped	100
74.5202.101	2.0 liters	Non-sterile	200
74.5202.001	2.0 liters	ETO* treated	200
74.5202.005	2.0 liters	Sterile, individually wrapped	100

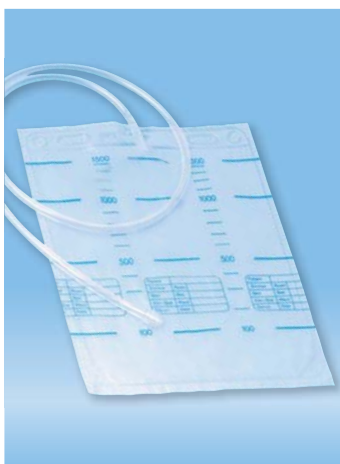

Gall secretion bag with Luer Lock

Order No.	Volume	Description	Packaging units/case
74.5206.005	1.5 liters	Sterile, individually wrapped	100
74.5207.005	1.5 liters with bottom drain	Sterile, individually wrapped	100

* Ethylene oxide



Comfort urine leg bag

- Comfortable with viscose flocked reverse
- Individually adjustable with 10 cm or 45 cm tube length
- Anti-reflux valve
- Fill volume 500 ml or 1,000 ml
- Easy to operate drainage valve with overnight connector attachment

Order No.	Description	Packaging units/case
74.5810.005	500 ml, tube length 10 cm individually packed, sterile	30
74.5810.101	500 ml, tube length 10 cm non-sterile	30
74.5815.005	500 ml, tube length 45 cm individually packed, sterile	30
74.5815.101	500 ml, tube length 45 cm non-sterile	30
74.5820.005	1,000 ml, tube length 10 cm individually packed, sterile	30
74.5820.101	1,000 ml, tube length 10 cm non-sterile	30
74.5825.005	1,000 ml, tube length 45 cm individually packed, sterile	30
74.5825.101	1,000 ml, tube length 45 cm non-sterile	30



Urine leg bag

- With straight or canted 10 cm tube attachment
- Anti-reflux valve
- Fill volume 750 ml, bottom drainage valve

Order No.	Description	Packaging units/case
74.5230.001	With straight inlet tube ETO* treated	200
74.5230.005	With straight inlet tube individually packed, sterile	50
74.5230.101	With straight inlet tube non-sterile	200
74.5231.001	With canted inlet tube ETO* treated	200
74.5231.005	With canted inlet tube individually packed, sterile	50
74.5231.101	With canted inlet tube non-sterile	200

* Ethylene oxide



Velcro band for securing leg bags

High level of wearer comfort due to:

- Wide, elastic design of retaining straps
- Skin-friendly, padded material
- Individual adjustment with three sizes
- Long-lasting and durable, can be washed multiple times (40°C)



Order No.	Description		Packaging units/case
74.5766.001	Size: S	380 - 430 mm	10
74.5766.002	Size: M	440 - 530 mm	10
74.5766.003	Size: L	550 - 650 mm	10



UroStretch leg bag attachment

An elastic, fabric tube for securing leg bags. Can be used with all urine leg bags up to 750 ml. The UroStretch can be used and washed repeatedly (40°C).

It offers a high level of wearer comfort due to:

- No contact between the leg bag and the skin (avoiding allergies, skin irritation)
- Fixation of the whole surface of the bag
- Individual adjustment with four sizes
- Reduction in noise caused by liquid

Order No.	Description		Packaging units/case
74.5767.001	Size: S (lower leg)	Color code yellow 	10
74.5767.002	Size: M	Color code blue 	10
74.5767.003	Size: L	Color code brown 	10
74.5767.004	Size: XL	Color code green 	10



The UroStretch is pulled up over the thigh so that the colored edge is towards the body. The red stripe should be roughly 5 cm above the knee.

The leg bag is applied and the drainage valve is placed in the center of the red stripe using the fixation opening.

Finally, the outer edge of the UroStretch (which is still on the lower leg) is pulled over the leg bag.

Pressure infusion cuffs Comfort range



Greater “comfort” with every use

- For arterial blood pressure measurement and pressure infusion and pressure transfusion of containers of volumes up to 1,000 ml
- Valve manometer unit for one-handed operation
- Latex-free, MRI-suitable
- Washable external cover

Order No.	Description	Packaging unit
97.8100.600	Pressure infusion cuff “S-Comfort” - Up to 500 ml volume - With fixed insertion	1
97.8100.610	Pressure infusion cuff “K-Comfort” - Up to 1,000 ml volume - Variable fit with Velcro fastener	1
97.8100.620	Pressure infusion cuff “FR-Comfort” - Up to 1,000 ml volume - Fixed back wall and variable fit with Velcro fastener - With additional insertion pocket for noting patient, medication, ward, etc.	1

Insertion pocket - for noting patient, ward, medication, etc.

- No mix-ups
- Prevents writing on covers

Spare parts

Order No.	Article name	Packaging unit
97.8100.630	Rubber bag, latex-free, 8 mm Internal tube diameter 8 mm	5 pieces
97.8100.631	VM unit Valve manometer unit for internal tube diameter 8 mm	1 piece
97.8100.632	Pressure ball for VM unit Pressure ball for use with valve manometer unit, red, latex-free	1 piece
97.8100.633	Outer cover for the ‘Standard-Comfor’ pressure infusion cuff	1 piece
97.8100.634	Outer cover for the “K-Comfort” pressure infusion cuff	1 piece
97.8100.635	Outer cover for the ‘FR-Comfort’ pressure infusion cuff	1 piece

Pressure infusion cuffs Classic range

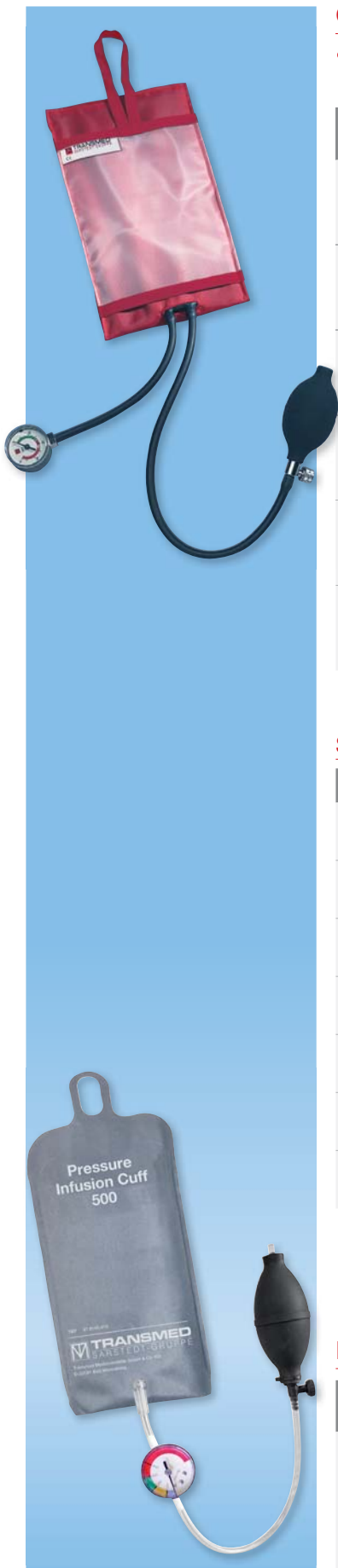

Quality that pays

- For arterial blood pressure measurement and pressure infusion and pressure transfusion of containers of volumes up to 1,000 ml

Order No.	Description	Packaging unit
97.8100.000	Pressure infusion cuff K - Up to 1,000 ml volume - Variable fit with Velcro fastener	1
97.8100.011	Pressure infusion cuff K latex-free - Up to 1,000 ml volume - Variable fit with Velcro fastener	1
97.8100.100	Pressure infusion cuff Standard - Up to 500 ml volume - With fixed insertion	1
97.8100.111	Pressure infusion cuff Standard latex-free - Up to 500 ml volume - With fixed insertion	1
97.8100.200	Pressure infusion cuff FR - Up to 1,000 ml volume - Fixed back wall and variable fit with Velcro fastener	1
97.8100.211	Pressure infusion cuff FR latex-free - Up to 1,000 ml volume - Fixed back wall and variable fit with Velcro fastener	1

Spare parts

Order No.	Article name	Packaging unit
97.8100.010	Rubber bag, latex-free	5 pieces
97.8100.001	Rubber bag, contains latex	5 pieces
97.8100.210	Outer cover FR	1 piece
97.8100.002	Outer cover K	1 piece
97.8100.102	Outer cover Standard	1 piece
97.8100.003	Manometer	5 pieces
97.8100.004	Pressure ball with valve, latex-free	5 pieces

Disposable pressure infusion cuff

Order No.	Description	Packaging unit
97.8100.410	Pressure Infusion Cuff 500 - For arterial blood pressure measurement and pressure infusion and pressure transfusion - Up to 500 ml volume	2

For transfusing all blood products

- Easy to use
- Free from latex and DEHP
- Suitable for pressure transfusion
- Filter sizes from 10 µm to 200 µm



TRANSMED 10

- Integrated cascade filter (175 µm, 40 µm and 10 µm)
- Effective elimination of microaggregates and fat particles

Order No.	Description	Packaging unit
79.8200.000	TRANSMED 10	100

TRANSMED 40

- Integrated cascade filter (175 µm and 40 µm)
- Higher filter capacity than TRANSFLOW and TRANSFLOW-N

Order No.	Description	Packaging unit
79.8200.100	TRANSMED 40	100

TRANSFLOW

- Integrated fine filter with a pore size of 40 µm

Order No.	Description	Packaging unit
79.8200.440	TRANSFLOW	100

TRANSFLOW-N

- Integrated fine filter with a pore size of 40 µm

Order No.	Description	Packaging unit
79.8200.490	TRANSFLOW-N	100

Transfusion device 200 µm

- Integrated fine filter with a pore size of 200 µm
- Meets the minimum requirements of transfusion medicine

Order No.	Description	Packaging unit
79.8200.500	Transfusion device 200 µm	300



HAEM-o-TRANS system for autologous direct retransfusion

- Closed low-vacuum system for collecting and retransfusing wound or drainage blood
- Latex-free
- Low vacuum preserves functional erythrocytes
- One-way valves prevent ascending infections
- No system exchange, only blood collection bags/drainage bags are changed
- Drainage of cell residues, blood and secretions over the whole drainage time
- Transfusion device enables the drainage of particles (e.g. fat) larger than 10 µm

Order No.	Description	Packaging unit
79.8400.100	HAEM-o-TRANS Unit - Set with quadruple connector: - Quadruple drain connector - Suction bellows with anti-reflux barrier - HAEM-o-TRANS blood collection bag 700 ml - Transfusion device 10 µm - Drainage bag 700 ml	20
79.8400.203	HAEM-o-TRANS set with Y connector - Y drain connector - Suction bellows with anti-reflux barrier - HAEM-o-TRANS blood collection bag 700 ml	20
79.8400.220	HAEM-o-TRANS blood collection bag 700 ml - 175 µm prefilter - With anti-reflux barrier	20
79.8400.230	HAEM-o-TRANS Transfusion device 10 µm - With integrated cascade filter 175 µm, 40 µm and 10 µm	20
79.8400.270	HAEM-o-TRANS drainage bag 700 ml - With anti-reflux barrier	20

Instruments for all areas of regional anesthesia: Innovative, impressive solutions!

- Development, production and distribution of high-quality instruments, 'Made in Germany'
- Modern manufacturing processes
- Reliable products
- In-house needle manufacturing
- Extensive product range
- Tested, certified product solutions
- Competent service



Suitable for ultrasound



- ✓ REGANESTH® pencil-point spinal needle in various designs with transparent **viewing chamber with magnifying effect** for the rapid identification of CSF
- ✓ Tuohy needle with **large wings** for better handling and needle guiding
- ✓ REGANESTH® unoplex for ultrasound-guided peripheral nerve blocks
- ✓ REGANESTH® duoplex for **nerve stimulation** and **sonographic representation**
- ✓ **Standardized regional anesthesia sets** and **customer-specific production**



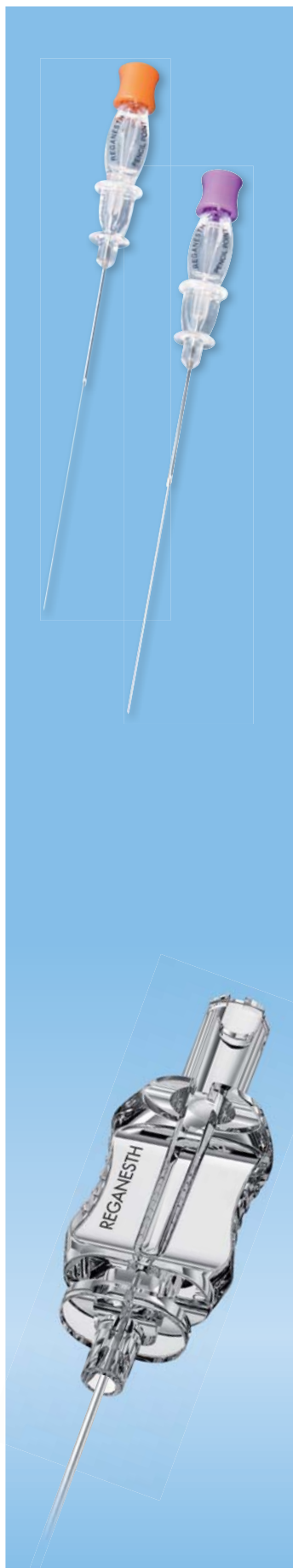

Spinal anesthesia

- The atraumatic shape of the pencil-point tip leads to very pronounced dural resistance. This enables a significant reduction in the post-puncture headache
- Anatomically shaped handle with non-glare and non-reflective viewing chamber for identifying even the smallest amounts of CSF
- The lateral opening, adapted to the internal diameter, leads to a rapid CSF return flow and thus rapid identification of the subarachnoid space
- The fit of the mandrin prevents tissue perforations and tissue being introduced into the spinal/epidural area
- The introducer, adapted to the needle length, offers a large free puncture length thanks to the handle design, and facilitates the introduction of thin, fine spinal needles

Order No.	Description	Packaging unit
79.8081.520	REGANESTH® spinal needle 27G x 38 mm pencil-point	20
79.8081.500	REGANESTH® spinal needle 27G x 90 mm pencil-point	20
79.8081.515	REGANESTH® spinal needle 27G x 90 mm pencil-point + introducer 32 mm	20
79.8081.503	REGANESTH® spinal needle 27G x 103 mm + introducer 32 mm	20
79.8081.510	REGANESTH® spinal needle 27G x 110 mm pencil-point	20
79.8081.530	REGANESTH® spinal needle 27G x 120 mm pencil-point	20
79.8081.540	REGANESTH® spinal needle 27G x 120 mm pencil-point + introducer 40 mm	20
79.8081.800	REGANESTH® spinal needle 25G x 90 mm pencil-point	20
79.8081.805	REGANESTH® spinal needle 25G x 90 mm pencil-point + Introducer 30 mm	20
79.8081.803	REGANESTH® spinal needle 25G x 103 mm + Introducer 30 mm	20
79.8081.840	REGANESTH® spinal needle 25G x 120 mm pencil-point + Introducer 40 mm	20
79.8081.811	REGANESTH® spinal needle 24G x 90 mm pencil-point + Introducer 30 mm	20
79.8081.812	REGANESTH® spinal needle 24G x 120 mm pencil-point + Introducer 40 mm	20
79.8081.210	REGANESTH® spinal needle 22G x 90 mm pencil-point	20
79.8081.900	Introducer 20G x 30 mm	20
79.8081.940	Introducer 20G x 40 mm	20
79.8082.210	Spinal needle 20G x 178 mm Quincke	20

All regional anesthesia products will shortly be available with ISO 80369-6 NRFit™ connectors

NRFit™

Non-Luer connector according to ISO 80369-6



Epidural anesthesia

- Large ergonomic grips for better handling and guiding of the Tuohy needle
- Long epidural catheter (1000 mm) for use in larger or overweight patients
- 3 lateral openings on the epidural catheter enable even anesthetic distribution
- Reliable flat filter fixation ensures secure attachment of the flat filter to the patient, thus minimizing the risk of catheter detachment
- Hypoallergenic bandage with Velcro fastening for flat filter fixation

Order No.	Description	Packaging unit
79.8083.100	Tuohy needle 18G x 80 mm	10
79.8083.110	Tuohy needle 18G x 90 mm	10
79.8083.500	Epidural catheter Epidural catheter 21G x 1000 mm, Tuohy-Borst adapter, flat filter 0.2 µm, hub insert	5
79.8089.150	Epidural catheter set 21G x 1000 mm Tuohy needle 18G x 90 mm, epidural catheter 21G x 1000 mm, Tuohy-Borst adapter, flat filter 0.2 µm, hub insert, L.O.R. Syringe	5
79.8089.210	CSE set 18G/27G • REGANESTH® spinal needle 27G x 120 mm pencil-point, Tuohy needle 18G x 90 mm, epidural catheter 21G x 1000 mm, Tuohy-Borst adapter, flat filter 0.2 µm, hub insert, L.O.R. Syringe	5
79.8086.000	Flat filter 0.2 µm	20
79.8086.050	REGAfix F flat filter fixation with Velcro	20

Regional anesthesia sets

- Standard sets available for regional anesthesia
- Customer-specific sets can be assembled

Order No.	Description	Packaging unit
79.8043.910	Anesthesia set Basic I 1x contents tray, 1x aperture drape 60 x 75 cm, 1x multi-use drape 30 x 40 cm, 1x clamp, 1x syringe 10 ml, 3 pcs., 2x syringes 5 ml, 3 pcs., 1x syringe 2 ml, 3 pcs., 1x needle 0.9 x 70 mm, 1x needle 0.4 x 40 mm, 4x swabs 25 x 26 cm, 4x compresses 7.5 x 7.5 cm, 4x compresses 5.0 x 5.0 cm, 1x waterproof underlay 80 x 80 cm	40
79.8088.920	Anesthesia set Spinal 25G x 90 1x contents tray; 1x aperture drape 70 x 90 cm with adhesive sheet and adhesive strips diameter 10 cm; 1x needle 0.9 x 70 mm; 1x needle 0.4 x 40 mm; 1x syringe 10 ml, 3 pcs. Luer; 2x syringe 5 ml, 3 pcs. Luer; 1x syringe 2 ml, 3 pcs. Luer; 1x clamp; 4x swabs 25 x 26 cm; 4x compresses, 7.5 x 7.5 ml; 4x compresses, 5.0 x 5.0 mm; 1x towel 30 x 40 cm; 1x waterproof underlay 75 x 80 cm; REGANESTH® pencil-point spinal needle 25G x 90 mm + Int.	40



Plexus anesthesia

REGANESTH® unoplex

- REGANESTH® unoplex needle for ultrasound-guided peripheral nerve blocks
- Excellent visibility thanks to *Rhombus Cut* ultrasound marker

Order No.	Description	Packaging unit
79.8096.050	REGANESTH® unoplex 22G x 50 mm	10
79.8096.080	REGANESTH® unoplex 22G x 80 mm	10
79.8096.188	Unoplex catheter set 18G/21G - REGANESTH® unoplex plexus needle 18G x 80 mm - Plexus catheter 21G x 400 mm with mandrin - Injection tube 60 cm - Tuohy-Borst adapter - Hub insert - Flat filter 0.2 µm - REGAfix flat filter fixation	5

REGANESTH® duoplex

- REGANESTH® duoplex stimulation needle for sonographic representation and nerve stimulation
- With extended injection tube and stimulation cable (60 cm)
- Ergonomically shaped handle for convenient operation

Order No.	Description	Packaging unit
79.8095.050	REGANESTH® duoplex 21G x 50 mm 30°	20
79.8095.070	REGANESTH® duoplex 21G x 70 mm 30°	20
79.8095.120	REGANESTH® duoplex 21G x 120 mm 30°	20

Plexus needle

- Unipolar atraumatic plexus needle with indwelling needle
- Flat filter 0.2 µm with a service life of up to 96 h
- Reliable flat filter fixation ensures safe attachment of the flat filter to the patient

Order No.	Description	Packaging unit
79.8091.000	Plexus needle 45° 20G x 48 mm	25
79.8092.005	Plexus needle 45° 18G x 51 mm	25
79.8092.200	Plexus catheter 21G x 400 mm with mandrin	10
79.8093.200	Plexus catheter set 21G/16G x 83 mm Plexus needle 45° 16G x 83 mm, Plexus catheter 21G x 400 mm with mandrin, Tuohy-Borst adapter, flat filter 0.2 µm, hub insert	10
97.8071.400	Connecting cable for plexus 45° needle	10
79.8086.000	Flat filter 0.2 µm	20
79.8086.050	REGAfix F flat filter fixation with Velcro	20



SAHARA-III

- Dry tempering device for thawing and heating plasma and blood components
- The risk of contamination from water-borne pathogens, as can occur with traditional water baths, is avoided
- Active drying of the component surface provides hygienic conditions in the area immediately surrounding the blood product
- Standardized thawing and heating process
- Contactless determination of the blood product temperature using an infrared sensor
- Integrated system test for checking device functions
- Documentation of temperature profile and system test using a log printer is possible
- **Note on module exchange:** Modular design enables rapid switching between the basic model and MAXITHERM

Order No.	Description	Packaging unit
97.8710.502	SAHARA-III basic model	1
97.8710.802	SAHARA-III MAXITHERM	1
Accessories		
97.8710.580	MAXITHERM module for SAHARA-III basic model	1
97.8710.590	Heating plate module for SAHARA-III MAXITHERM	1
97.8710.550	Infusion heater module for SAHARA-III	1
97.8710.570	Protocol printer module	1
79.8710.575	Paper roll protocol printer	10
79.8710.576	Ink ribbon protocol printer	1
97.8710.501	Stainless steel collecting tray	1

SAHARA-TSC

- Dry tempering device for the standardized thawing of cryo-preserved leukapheresis products
- Enables the quick, temperature-controlled thawing of cryo-preserved leukapheresis products



Order No.	Description	Packaging unit
97.8710.602	SAHARA-TSC	1
Accessories		
79.8710.610	Adaptation compress - TSC	5
97.8710.620	Warming dish SAHARA-TSC	1
97.8710.570	Protocol printer module	1
79.8710.575	Paper roll protocol printer	10
79.8710.576	Ink ribbon protocol printer	1

Syringe labeling

Mixing up medications is a latent danger in clinical practice. There are also several risk sources that can ultimately lead to serious consequences for patients. In addition to incorrect medications due to connection errors, e.g. with neuraxial and intravenous administrations, unstructured labeling of syringes can also lead to serious medication mix-ups.

The latest DIVI recommendation from 2012 refers to ISO 26825 with regard to this issue. The idea behind this standard is that all medications are classified into a substance group, which is in turn attributed a color. This means that in the event of mix-ups within the same color (active substance group), the “effective direction” can at least be maintained, meaning that fewer serious consequences are to be expected.

SARSTEDT AG & Co. KG offers a wide range of labels based on ISO 26825 and DGAI and DIVI recommendations, which can be found at www.sarstedt.com.

Self-adhesive labels

- Syringe labeling according to ISO 26825 and DGAI/DIVI recommendation
- Avoidance of incorrect medications by standardized color-coded labeling of active substance groups
- Consistent separation from antagonists through horizontal strips
- Compatible with label dispensers 97.8300.500 and 97.8300.501

Order No.	Description	Packaging unit
79.8300.557	ISO labels Self-adhesive labels as per ISO 26825 (DGAI/DIVI), size 35 x 13 mm	Roll of 1,000 pieces
79.8300.558	DIVI perfusor labels Self-adhesive labels as per DIVI recommendation, size 80 x 40 mm	Roll of 500 pieces
79.8360.003	DIVI background label B For stating initials, time and date as well as the active substance amount, solution and total amount	100 sheets of 12 labels
79.8360.004	DIVI background label R For stating initials, time and date as well as the active substance amount, solution and total amount	Roll of 500 pieces
97.8300.500	Label dispenser with cover Holds 7 rolls of ISO labels	1 piece
97.8300.501	Maxi label dispenser with cover Holds 10 rolls of ISO labels or 4 rolls of DIVI perfusor labels	1 piece





Other medical devices

- Practical accessories for clinical practice

Order No.	Description	Packaging units/case
97.8300.450	TRANSKAT catheter quiver Height: 45 cm Diameter: 10 cm	1
97.8300.460	TRANSKAT cover Height: 25 cm	1
97.8300.400	Fixing clamp R suitable for rail systems, table plates, etc.	1
97.8300.600	Tube holder with clip, with Velcro to be attached anywhere by means of the clip closure, length: 10 cm	15
97.8300.601	Tube holder with hook, with Velcro to be attached anywhere by means of the hook, length: 15 cm	15
97.8300.610	Tube holder, long with 2 clips, with Velcro to be attached on both sides by means of the clip closure, length: 25 cm	10



Accessories for blood bags

Order No.	Description	Packaging units/case
79.8701.990	Sealing locks for blood bags For sealing the neck on blood bags	700 individual, sterile packaged items



Navel clamp

- For the safe closure of the umbilical cord after delivery
- Sterile, individually wrapped

Order No.	Packaging units/case
74.4701	250



The latest technology for the collection, processing and use of blood units – SARSTEDT pursues a systematic transfusion technology.

We offer an extensive range of transfusion products that are user-friendly, efficient, and safe.

The innovative three-dimensional tilting and swinging motion of the TOPSWING blood mixing and weighing machine guarantees highly efficient mixing of blood and stabilizer solution. Lithium-ion battery technology with an integrated battery changing system enables sufficient donation time during mobile blood donation.

TRANS Control is used to transport temperature-sensitive blood products, such as erythrocyte concentrates, platelet concentrates, frozen fresh plasma, etc.

The products to be transported are kept at a constant temperature level without active temperature regulation.

The temperature range is maintained by a coolant, which is found in the pre-tempered elements of the TRANS Control or TRANS Control spaces.



Blood mixing and weighing devices	
TOPSWING PRO II	208
TRANSWAAG PRO	209
Sealing & stripping	
Tube sealing device MS 1000	210
Blood tube sealing devices	211
Tube stripper · Stripping/sealing tongs	212
Transport and storage	
ThermoScan temperature monitoring	213
TRANS Control	214
Incubators & agitators	
Incubators · Agitators	215
Accessories for blood donation	
Blood donation seat/table · Radiation indicator	216
Blood bag for autologous blood transfusion · Glass tube for Coombs test · Tube segment openers	217



TOPSWING PRO II

Safe whole blood donation with efficient data management

- Innovative mixing motion
- Large VGA graphics display
- Modular design characteristics

Order No.	Description
97.8700.410	TOPSWING PRO II - With 2x scanner port, 3x USB, 1x RS 232, 1x RJ 45 - Mains-free operation using Li-ion battery technology - Donation data back-up via USB, RS 232, Ethernet or radio

Order No.	Accessories
97.8700.420	TS Power Charger Charging station with power cable - Enables the quick and simultaneous charging of up to 12 TS Power Packs, regardless of the charging status
97.8700.423	TS Li-Ion power pack Mobile power supply unit with integrated charging unit and connection for TS Power Pack module - Enables the mains-free operation of the TOPSWING via the TS power pack module
97.8700.430	TS Power Pack module Adapter module for connecting the TS Power Pack to the TOPSWING - Incl. integrated drawer for storing the TOUCH 65 PRO scanner and accessories
97.8700.431	TS Seal module Adapter module for connecting the TOPSWING with integrated sealing tongs - Incl. integrated drawer for storing the manual crimping tool, cable and accessories
97.8700.432	TS Transport module Storage and transport cover for TOPSWING - Can be stacked, allows the height of TOPSWING to be adjusted during donation
97.8700.433	TS Level module Allows the height of TOPSWING to be adjusted during donation
97.8700.440	TOUCH 65 PRO scanner Barcode scanner with port for TOPSWING
97.8700.445	USB stick Mobile data carrier
97.8700.450	TS Script Manager - Enables the convenient adjustment of the TOPSWING and the configuration of the scan sequence during donation - Incl. installation CD for Windows
97.8700.452	TRANSComm II - Enables data exchange between the TOPSWING and PC - Incl. installation CD for Windows
97.8700.453	Customized TS software Customization of TS software according to user requirements
97.8700.461	DECT radio module USB base station Enables data communication with the TOPSWING PRO radio module via TRANSComm II - Connects to PC via USB 2.0 interface
97.8700.466	TS data cable RS 232 3 m For connecting the TOPSWING to a PC via the RS 232 interface
97.8700.467	TS data cable RJ 45 3 m For connecting the TOPSWING to a PC via the RJ 45 interface
97.8700.470	TS remote control For the convenient operation of the TOPSWING
97.8700.980	Calibration weight 500 g Precision weight class M1 for calibrating the TRANSWAAG/TOPSWING

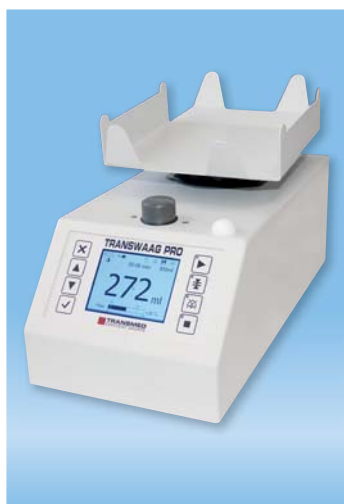

TRANSWAAG PRO

A tried and tested classic model with the latest technology

- Light weight
- Large graphic color display
- Various data management functions
- Sturdy aluminium casing

Order No.	Description
97.8700.105	TRANSWAAG PRO - With 1x scanner port, 1x USB, 1x RS 232, 1x RJ 45, 1x battery - Mains-free operation using Li-ion battery technology - Donation data back-up via USB, RS 232, radio or Ethernet

Order No.	Accessories
97.8700.233	TW-Power-Pack Li-Ion Li-ion battery with integrated charging unit - Can be integrated into the transport case - Battery powered operation of the TRANSWAAG for at least 30 hours
97.8700.238	16 port RS 232 interface module Adds sixteen RS 232 interfaces to a standard PC
97.8700.239	TW data cable RS 232 3 m. For connecting the TRANSWAAG to a serial PC interface
97.8700.243	TW TOUCH 65 PRO scanner Shock-resistant, non-wearing barcode scanner
97.8700.261	Customer-specific TW software Individual adaptation of the TRANSWAAG PRO operating system to your requirements, e.g. - Configuration of option menu - Number of scan steps - Data transfer online or via USB - Communication with central host computer
97.8700.275	TW Pro radio module Module for radio data transfer to a host computer
97.8700.445	USB stick Mobile data carrier
97.8700.985	TW PRO transport case - Transport case does not need to be opened to charge the battery - Lighter, sturdier plastic transport case - Can be stacked - For carrying the TRANSWAAG PRO, TW Li-Ion power pack, mains adapter, scanner and USB stick

Sealing & stripping

Tube sealing device MS 1000

- RF sealing device
- Modular design
- Touchscreen operation
- Maintenance and test program
- Solid sealing head
- Tube sensor
- Replaceable electrodes
- Wide sealing seam, 4 mm
- Sturdy, high quality device
- Various fastening rails (device base)



MS 1000



The versatile MS 1000 blood tube sealing device was developed as a stand-alone device for use during blood donations or as a segmenter in combination with several devices for blood component production.

The MS 1000 features a modern touchscreen that enables additional functions for maintenance and trouble-shooting as well as general operation.

Simply combine several individual devices for use as a segmenting device by locking units onto a rail. Connect with a control cable and a pre-assembled mains lead with a central ON/OFF switch.

Order No.	Description	Packaging/ item
87.7708.800	MS 1000, incl. device base, power and control cable, transport case	1
87.7708.813	Equipment rail for 3 devices	1
87.7708.814	Equipment rail for 4 devices	1
87.7708.815	Equipment rail for 5 devices	1
87.7708.823	Mains lead with ON/OFF switch for 3 devices	1
87.7708.824	Mains lead with ON/OFF switch for 4 devices	1
87.7708.825	Mains lead with ON/OFF switch for 5 devices	1
87.7708.833	Base plate with handle for 3 devices	1
87.7708.834	Base plate with handle for 4 devices	1
87.7708.835	Base plate with handle for 5 devices	1

Blood tube sealing devices

- RF sealing device
- Precise sealing seam
- Easy separation of the sealing joint
- Indicator light and audible signal after sealing
- Easy electrode exchange
- Easy to clean
- Removable battery (MS 500B)
- Robust sealing tongs
- Sturdy casing



MS 500M

MS 500B

The MS 500M (mains power) and MS 500B (battery power) hand-held sealers are for use during blood donations or blood component production.

The manual crimping tool has a special mechanism that offsets individual differences in handling to ensure safe, consistent sealing.

The sealing head cover and electrodes are easy to remove for cleaning.

Order No.	Description	Packaging/ item
87.7708.850	MULTI SEALER MS 500M blood tube sealing device Mains power supply 230 V with manual sealing tongs and transport case Cable length: 1.8 m Size: 18 x 5.5 x 23 cm (W x H x D) Weight: 2 kg	1
87.7708.860	MULTI SEALER MS 500B blood tube sealing device Battery power supply 24 V with manual sealing tongs and transport case Cable length: 1.8 m Battery: NiMH 24 V/1700 mAh (replaceable) Size: 18 x 5.5 x 17 cm (W x H x D) Weight: 2 kg	1



Electronic tube stripper for stripping blood bag tubing

- Electric motor drive
- Mains adapter or battery power
- Control switch for forward and reverse motion
- Versions with and without auto-stop function (automatic stop on blood bag)
- Manual device or tabletop device with foot pedal
- Weight 750 g

Order No.	Description	Packaging/ item
87.7709.029	AST-2 tube stripper incl. transport case (Device without mains adapter - battery pack/charging device)	1
87.7709.025	AST-2S tube stripper with auto-stop function incl. transport case (Device without mains adapter - battery pack/charging device)	1
87.7709.035	AST-2F tube stripper tabletop device with auto-stop function and foot pedal (Device without mains adapter - battery pack/charging device)	1
87.7709.033	Universal mains adapter 100-240 VAC, 50-60 Hz, 700 mA/7.5 VDC, 3.3 A	1
87.7709.031	Battery pack 7.2 V, 700 mA	1
87.7709.032	Universal battery charging device for item no. 87.7709.031 100-240 VAC, 50-60 Hz	1



Stripping and sealing tongs

Order No.	Description	Material	Packaging/ item
97.8800.200	Stripping/sealing tongs	Aluminium	1
88.7708.095	Sealing clips	Aluminium	1,000

ThermoScan

- Convenient system for temperature-controlled blood product transport





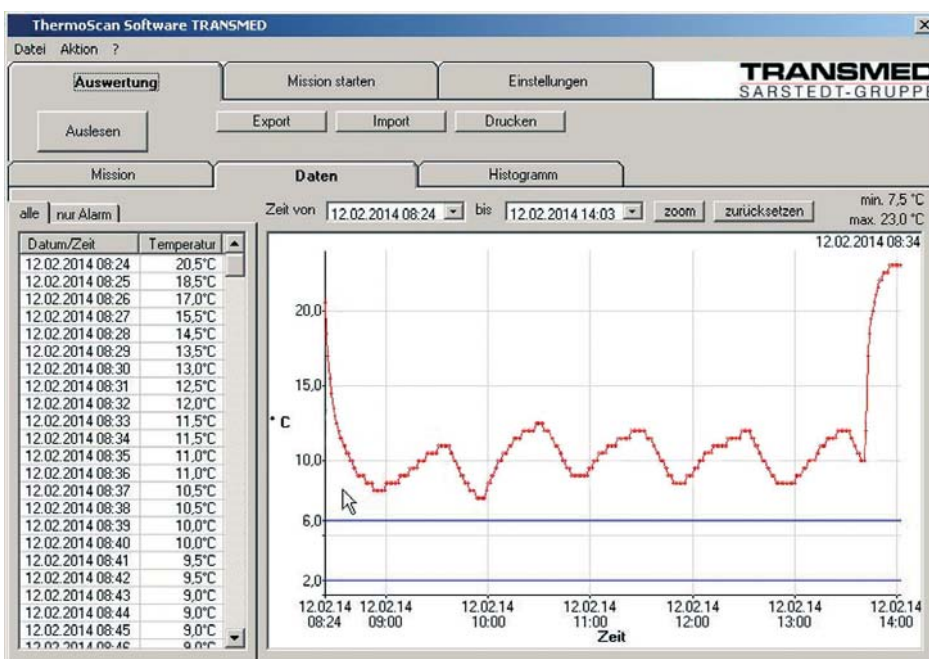



Order No.	Description
97.8750.151	ThermoScan Data Logger TM Temperature data logger for monitoring transport conditions - Operating range -40° to +85°C - Dimensions: Diameter 17 mm, height 6 mm - Includes calibration certificate
97.8750.153	ThermoScan Port Adapter - 9-pin connection for serial PC-COM port
97.8750.154	ThermoScan Reading Unit Reading unit for ThermoScan temp. data logger to connect to port adapter (item no. 97.8750.153)
97.8750.156	ThermoScan USB Port Adapter To connect the ThermoScan reading unit to a PC USB port
97.8750.157	ThermoScan Software TRANSMED Software for the configuration and evaluation of the ThermoScan data logger using Microsoft Windows® - With graphic display and export function
97.8750.160	ThermoScan Set 1 port adapter (item no. 97.8750.153) with 9-pin connection for PC-COM port - Reading unit (item no. 97.8750.154) for connecting to the port adapter - ThermoScan Software TRANSMED (item no. 97.8750.157) for programming and evaluating the ThermoScan data logger using Microsoft Windows - ThermoScan-Temp. data logger (item no. 97.8750.151)
97.8750.161	ThermoScan Set USB As ThermoScan Set (97.8750.160), but with 1 USB port adapter (item no. 97.8750.156)





TRANS Control

- For the transport of blood products maintaining the transport temperature specified

Order No.	Description	Color code	Packaging/ item
97.8750.000	TRANS Control 4° Double element for transporting erythrocyte concentrates and whole blood preparations at temperatures of 2° to 6° Celsius		1
97.8750.001	TRANS Control 4° Frame For expanding the capacity of the TRANS Control 4°		1
97.8750.010	TRANS Control 22° Double element for transporting platelet concentrates at room temperature (22° Celsius)		1
97.8750.011	TRANS Control 22° Frame For expanding the capacity of the TRANS Control 22°		1
97.8750.015	TRANS Control 37° Double element for transporting whole blood preparations at 37° Celsius		1
97.8750.016	TRANS Control 37° Frame For expanding the capacity of the TRANS Control 37°		1
97.8750.018	TRANS Control -18° Double element for transporting frozen blood products		1
97.8750.019	TRANS Control -18° Frame For expanding the capacity of the TRANS Control -18°		1
97.8750.020	TRANS Control -30° Double element for transporting FFP and frozen lab samples at temperatures of -30° to -32° Celsius		1
97.8750.021	TRANS Control -30° Frame For expanding the capacity of the TRANS Control -30°		1
97.8750.140	TRANS Control Mono Box Styrofoam packaging for 1 TRANS Control double element - The 60 - 80 mm-thick insulation protects sensitive products from temperature changes, shocks and impacts - - Mono Box can be extended to Mono/Triple Box - Can be reused		1
97.8750.141	TRANS Control Triple Box Styrofoam packaging for 3 TRANS Control double elements - The 60 - 80 mm-thick insulation protects sensitive products from temperature changes, shocks and impacts - Triple Box can be reduced to Mono/Triple Box - Can be reused		1
97.8750.142	TRANS Control Mono/Triple Box Styrofoam packaging for 2 TRANS Control double elements - The 60 - 80 mm-thick insulation protects sensitive products from temperature changes, shocks and impacts - Mono/Triple Box can be reduced to Mono Box and extended to Triple Box - Can be reused		1
97.8750.143	Outer box for Mono/Triple Box Packaging box for sending Mono, Mono/Triple and Triple Box - Protects the box in case of repeated use - Labeling possible		20
97.8750.050	Transport box For 4 TRANS Control Double elements or 1 TRANS Control double element with 3 TRANS Control Frames - With additional insulation - Lockable - Plastic inner part in base and cover, handle		1

Incubators and agitators for platelet storage



- Stainless steel casing
- Fully insulated interior
- Single doors with insulating glass and magnetic seal
- Automatically stops when door is opened
- Monitors temperature, doors and agitators
- Measurement of agitator speed
- Alarm parameters can be freely selected
- Collective alarm port
- RS232 interface
- Graphic data logger
- Rollers or castors
- External temperature probe (optional)

Order No.	Description	Packaging/ item
87.7708.909	Flat bed platelet agitator TA-3 for approx. 24/8 bags Size: 448 x 250 x 350 mm (WxHxD) Power supply: 230 VAC 50-60 Hz/20 VA Weight: 20 kg	1
87.7708.911	Flat bed platelet agitator TA-2 for approx. 48/16 bags Size: 448 x 370 x 350 mm (WxHxD) Power supply: 230 VAC 50-60 Hz/20 VA Weight: 24 kg	1
87.7708.910	Flat bed platelet agitator TA-1 for approx. 96/32 bags Size: 850 x 400 x 350 mm (WxHxD) Power supply: 230 VAC 50-60 Hz/20 VA Weight: 40 kg	1
87.7708.913	Platelet incubator TI-0 Incubator cupboard, + 22°C, +/- 1/2°C, Holds 1x Agitator TA 2 or 1x TA 3 Size: 686 x 800 x 650 mm (WxHxD) Power supply: 230 VAC 50-60 Hz/705 VA Weight: 75 kg	1
87.7708.915	Platelet incubator TI-1 Incubator cupboard, + 22°C, +/- 1/2°C, Holds 2x Agitator TA 2 or 1x Agitator TA 1 Size: 1042 x 893 x 648 mm (WxHxD) Power supply: 230 VAC 50-60 Hz/705 VA Weight: 95 kg	1
87.7708.916	Platelet incubator TI-2 Incubator cupboard, + 22°C, +/- 1/2°C, Holds 4x Agitator TA 2 or 2x Agitator TA 1 Size: 1042 x 1403 x 648 mm (WxHxD) Power supply: 230 VAC 50-60 Hz/705 VA Weight: 156 kg	1
87.7708.914	Platelet incubator TI-3 Incubator cupboard, + 22°C, +/- 1/2°C, Holds 6x Agitator TA 2 or 3x Agitator TA 1 Size: 1042 x 1913 x 648 mm (WxHxD) Power supply: 230 VAC 50-60 Hz/705 VA Weight: 210 kg	1
88.7740.102	Record charts for circular chart recorder 120 mm diameter, 0 to 30°C	50
88.7740.109	Record charts for circular chart recorder 150 mm diameter, (inner) + 50 to - 5°C (outer) type CEC/TI model	50
88.7740.103	Marker pen for circular chart recorder	2

Accessories for blood donation



Blood donation seat/table

- For safe and easy use during mobile blood donations

Order No.	Description	Packaging/ item
97.8700.310	Mobile blood donation seat - Ensures a comfortable and relaxing lying position - Rapid and easy handling when setting up and folding together - Convenient to transport due to the compact dimensions	1
97.8700.330	Mobile blood donation table Side table for mobile blood collection - WxDxH: 55 cm x 40 cm x 70 cm - Sturdy - Foldaway - Easy to transport	1
97.8700.335	Mobile blood donation table XL Side table for mobile blood collection - WxDxH: 95 cm x 45 cm x 73 cm - Sturdy - Foldaway - Easy to transport	1
79.8673.901	Headrest cover - 28 x 32 cm with Velcro fastener	100

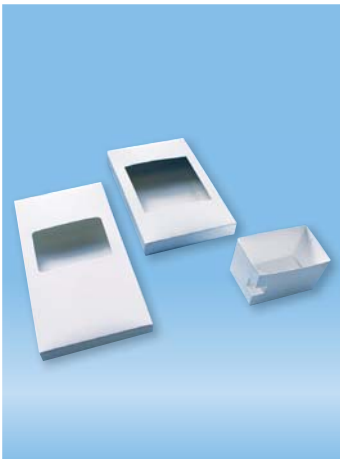

Box for plasma bags

- Suitable for snap-freezing
- Custom options on request

Order No.	Description	Size in mm	Packaging/ item
95.7780.191	Box for cryoprecipitate	114 x 22 x 114	10
95.7780.192	Box for FFP	200 x 25 x 130	10
95.7780.193	Box for FFP	127 x 44 x 116	10



Radiation indicator

- For the semi-quantitative determination of radiation intensity
- Versions for gamma or x-ray radiation

Order No.	Description	Packaging/ item
88.7750.400	Rad-Tag® radiation indicator Gy25/50 Gamma	200
88.7750.415	Rad-Tag® Radiation indicator Gy15/50 X-ray	200



Blood bag for autologous blood transfusion

Order No.	Description	Packaging/ item
88.7801.933	Triple blood bag, 500 ml, O/U system, venous needle, 500 ml, CPD/PPAGGS-M, MINI BAG with SARSTEDT multi adapter for S-Monovette®, and Y-part with female. Luer lock, 2 items/pack Manufacturer item no. 8001933	On request
88.7801.149	Quadruple blood bag O/U system for placental blood sampling 1 x venous needle 150 ml, 17 ml CPD/150 ml empty/150 ml empty/100 ml/20 ml SAG-M/with 1 clamp, Manufacturer item no. 8001149	On request



Glass tubes for Coombs test

- Uniform wall thickness, secure packaging

Order No.	Volume in ml	Length/Ø in mm	Packaging units/ case
86.1509	5	75/11.5	294/box 2,352/outer box



Tube segment openers

Safety and hygiene for your cross-matching laboratory

- Easy sampling from tube segments
- Minimal risk of contamination

Order No.	Description	Packaging
95.1000	Tube segment openers	2,000/case
95.1000.476	Tube segment opener with tube 75 mm, diameter 12 mm, assembled	400/case, StackPack
95.1000.800	Tube segment opener for tube with inner diameter 8.2 mm	2,000/case
55.476.300	Tube 75 mm, diameter 12 mm, PS	2,000/case, StackPack
55.476.305	Tube 75 mm, diameter 12 mm, PS	2,000/case
86.1509	Tube 75 mm, diameter 11.5 mm, glass	2,352/case, StackPack

Tube segment opener for bed-side test cards

Order No.	Description	Packaging
95.1000.100	Tube segment opener for bed-side testing	200/inner box 2,000/box

PS = transparent polystyrene

Our philosophy: uncompromising quality management

Quality management means the systematic planning of all product development phases.

From market analysis to delivery of the finished product to the customer, each individual phase is subject to a planning and verification process.

EN ISO 13485 DE-M

TRBA 250

CE ISO 8669

ISO 26825

Biosphere® plus

PCR Performance Tested

P 650

AFNOR



ISO 14820

ISO 23907

Disposal and the Environment

- ✓ Plastics used in our products are environmentally neutral in terms of disposal.
- ✓ The plastic can be sent to landfill, as they do not release any harmful substances into the air, earth or water.
- ✓ When disposed of in incinerators, the plastics PS, PP, PC and PE serve as valuable sources of energy to maintain the temperature in the combustion chamber - the more plastic in the waste, the less heating fuel is used. Burning these plastics does not release any hazardous emissions.

	Polystyrene	Polypropylene	Polycarbonate	Polyethylene
Abbreviation	PS	PP	PC	HD-PE High Density LD-PE Low Density
Optical Properties	transparent, shiny surface with 90% light transmission (at 400-800 nm)	translucent, shiny surface	transparent, 88% light transmission (at 400-800 nm)	translucent to opaque, waxy surface
General Mechanical Properties	Low break and thermal resistance, very good electrical insulating properties, not suitable for high centrifugal forces	high breaking strength, resistant to stress cracking, stable form and high rigidity	very good mechanical, optical, electrical and thermal properties, can be autoclaved and sterilized	Relatively low tensile strength and surface hardness, high toughness, soft to firm, sensitive to stress cracking, water-repellent
Autoclavability	Not suitable	Products made of PP can be autoclaved up to 121°C without any appreciable loss of mechanical properties. The user must check whether other product characteristics are affected in terms of the desired use.	Products made of PC can be autoclaved up to 121°C without any appreciable loss of mechanical properties. The user must check whether other product characteristics are affected in terms of the desired use.	Not suitable
Max. continuous use temperature*1	60 - 70°C	100 - 110°C	115 - 125°C	HD-PE 70 - 80°C • LD-PE 60 - 75°C
Short-term maximum use temperature*1	75 - 80°C	120 - 140°C	125 - 140°C	HD-PE 90 - 120°C • LD-PE 80 - 90°C
Use at sub-zero temperatures*2	Unsuitable	Suitable for limited applications	down to -80°C	Suitable for limited applications
Density g/cm³	1.05	0.90	1.19	HD-PE 0.95 • LD-PE 0.92
Flammability	Flammable	Flammable	Flammable	Flammable
Ignition temperature*1	300 - 400°C	300 - 360°C	380 - 450°C	350 - 360°C
Moisture absorption	< 0.1%	< 0.1%	0.1 - 0.3%	< 0.1%
General resistance to chemicals	PS is resistant to saline solutions, bases, non-oxidizing acids, alkalis and alcohols. Benzene, volatile oils, strongly oxidizing agents and aromatics attack PS, forming stress cracks.	PP is resistant to aqueous solutions of inorganic salts, acids, alkalis and to organic solvents up to 60°C. Alcohols, esters and ketones also do not attack PP. Aromatic and halogenated hydrocarbons, oxidizing substances such as concentrated nitric acid and fats, oils and waxes at high temperatures cause PP to swell.	PC is resistant to higher concentrations of mineral acids, many organic acids (e.g. carbonic acid, oleic acid and citric acid), oxidants, reducing agents, neutral and acidic saline solutions, a range of fats and oils, saturated, aliphatic and cycloaliphatic hydrocarbons and alcohols (except methanol). Bases, ammonia gas and solution as well as amines attack PC. PC is soluble in a range of industrial solvents. Other organic compounds like benzene, acetone and carbon tetrachloride eventually lead to expansion or swelling.	PE has a high resistance to chemicals. The chemical resistance of HD-PE is generally higher than that of LD-PE. Diluted acids, alkalis, alcohol, oil and water and saline solutions do not affect PE. Concentrated, oxidizing acids, such as nitric acid and halogens, have a corrosive effect.
Disposal	PS is a pure hydrocarbon and thus environmentally neutral in terms of disposal. The controlled burning of this plastic does not release any hazardous emissions.	PP is a pure hydrocarbon and thus environmentally neutral in terms of disposal. The controlled burning of this plastic does not release any hazardous emissions.	PC is a pure hydrocarbon and thus environmentally neutral in terms of disposal. The controlled burning of this plastic does not release any hazardous emissions.	PE is a pure hydrocarbon and thus environmentally neutral in terms of disposal. The controlled burning of this plastic does not release any hazardous emissions.

*1 Suitability depends on the type of plastic used and the type of stress.

*2 Attention: The plastic becomes brittle at sub-zero temperatures. The use of products at sub-zero temperatures should be tested in advance for the relevant application. This information should serve as a guide and does not guarantee product properties.

Safety notice

For safety reasons, CryoPure tubes should always be stored in the gas phase of liquid nitrogen.

During the freezing process, a vacuum builds up inside the containers, the size of which is dependent on the filling quantity (freezing quantity). If the CryoPure tubes are kept in liquid nitrogen, liquid nitrogen may enter the tubes due to this vacuum. During tube removal/the thawing process, the liquid nitrogen becomes gas and creates internal pressure. This can lead to infectious material escaping from the tubes, or the tubes exploding. If liquid nitrogen enters the containers, this can also lead to the contamination of the sample material with impure nitrogen.

When dealing with CryoPure tubes, safety measures should always be observed:

- Only store tubes in the gas phase.
- Fill containers to the fill mark.
- Close tubes by hand, do not overtighten and do not use tools.
- Protective clothing, face protection, eye protection and gloves should be used.
- During thawing, place tubes in a container (e.g. water bath) with a cover.

Please observe your internal laboratory safety guidelines!

Standard protocol for freezing mammalian cells

- Wash the cells with PBS.
- Detach the cells using a suitable method for the cell type (e.g. treating the cell layer with EDTA, trypsin or EDTA-trypsin solution).
- Stop the reaction with serum-containing cell culture medium.
- Determine the number of cells using a Neubauer counting chamber.
- Centrifuge the cells (5 min., 350 x g, RT), discard supernatant.
- Resuspend the cell pellet in serum-containing culture medium, adjust the cell count to approx. 10^7 cells/ml.
- Add 1 volume double concentration freezing medium (e.g. 50% medium, 30% FCS, 20% DMSO); the cell count should be approx. 5×10^6 cells/ml.
- Fill the CryoPure tubes up to the fill mark.
- Freeze the samples in an insulated container at -80°C , ensuring a cooling rate of approx. $1^{\circ}\text{C}/\text{min}$. The cells should be stored at -80°C for at least 6 hours. Depending on cell type, cells may also be kept viable at -80°C for several days.
- Transfer the tubes to the nitrogen tank.

Standard protocol for thawing

- Remove CryoPure tubes from the nitrogen container and quickly place into a 37°C water bath and cover.
- After thawing, disinfect the tubes with 70% alcohol and let dry.
Transfer the cell suspension into a 15 ml centrifuge tube (e.g. item no. 62.554.100).
- Add culture medium and centrifuge the cells (5 min., 350 x g, RT).
- Discard the supernatant and resuspend the cells in a suitable amount of fresh cell culture medium.
- Fill a cell culture flask and incubate.

Chemical resistance

The table of chemical resistance listed here should be used as a general guideline. All data are non-binding recommendations, taken from information supplied by the plastic manufacturer and the literature. Users must check the resistance of plastic materials under their specific test conditions, including with regard to uses that involve any mixtures of chemical substances or changes in temperature.

The first letter of the evaluation relates to conditions at + 20°C, and the second to conditions at + 60°C.

	LD-PE	HD-PE	PP	PS	PC
1,4-Dioxane	GL	GG	LL	UU	UU
1-Chloropentane	UU	LU	UU	UU	UU
2-Pentanone	UU	UU	GL	UU	UU
Acetaldehyde	LU	GL	GU	UU	UU
Acetic acid, 5%	EE	EE	EE	EE	EG
Acetic acid, 50%	EE	EE	EE	GG	LL
Acetone	LU	LL	EG	UU	UU
Allyl alcohol	LL	EE	—	EL	—
Aluminium salts	EE	EE	EE	GG	—
Amino acids	EE	EE	EE	EE	EE
Ammonia	EE	EE	EE	GL	UU
Ammonium carbonate	EE	EE	EE	EE	LU
Ammonium phosphate	EE	EE	EE	GG	—
Ammonium sulphate	EE	EE	EE	GG	EG
Aniline	UU	GG	GL	UU	UU
Benzene	UU	LU	LU	UU	UU
Benzine	LU	LL	UU	UU	LL
Benzyl alcohol	GL	GG	GL	UU	LL
Boric acid	EE	EE	EE	EG	EE
Bromine	UU	UU	UU	UU	UU
Butanol	EL	EE	EL	GG	UU
Butanone	LU	GG	GL	UU	UU
Butyric acid	LU	GL	LU	UU	LU
Calcium chloride	EE	EE	EE	EE	EE
Calcium hydroxide, sat.	EE	EE	EE	GG	UU
Calcium sulphate	EE	EE	EE	GG	EE
Carbon tetrachloride	UU	LU	UU	UU	UU
Chlorine 10% in water	UU	LU	LU	UU	LU
Chlorobenzene	UU	UU	UU	UU	UU
Chromic acid, 10%	EE	EE	EL	EE	GL
Chromic acid, 50%	EE	EE	GL	LL	LU
Citric acid, 10%	EE	EE	EE	EE	EE
Cresol	UU	LU	GL	UU	UU
Cyclohexanol	UU	UU	E-	UU	E-
Dichloromethane	LL	UU	LU	UU	UU
Diethyl ketone	LU	LL	GG	UU	UU
Dimethyl sulphoxide	EE	EE	EE	EG	UU
Ethanol, 95%	LL	GG	EE	EE	GG
Ethyl acetate	LU	EU	LU	UU	UU
Ethylbenzene	UU	UU	LU	UU	LL
Ethylene glycol	EE	EE	EE	EE	EE
Ethylene oxide	LL	GL	LL	UU	LU
Fluoride	EE	EE	EE	GG	—
Fluorine	UU	UU	LU	UU	—
Formaldehyde, 10%	EE	EE	EE	LU	EG
Formaldehyde, 40%	GL	EG	EG	UU	LL
Formic acid	EG	EE	EU	LL	LU
Glacial acetic acid	LU	EL	EL	UU	UU
Glycerol	EE	EE	EE	EE	EE
Heating oil	LU	GL	EG	UU	GL
Hexane	LL	GL	GL	UU	LU
Hydrochloric acid, 20%	EE	EE	EE	EE	LL
Hydrochloric acid, 35%	EE	EE	EL	LL	UU
Hydrochloric acid, 5%	EE	EE	EE	EE	EE
Hydrofluoric acid, 4%	EG	EE	EG	GL	GL
Hydrofluoric acid, 40%	EE	EE	E-	UU	—
Hydrofluoric acid, 48%	EG	EE	EG	UU	UU
Hydrogen cyanide	EE	EE	EE	GG	—
Hydrogen peroxide, 3%	EE	EE	EE	EG	EE
Hydrogen peroxide, 30%	EL	EE	EL	EG	EE
Isobutanol	EL	EE	EE	GG	EE
Isopropyl acetate	GL	EL	GL	UU	UU
Isopropyl alcohol	EE	EE	EE	EG	L-
Kerosene	UU	UU	GL	UU	LL
Lactic acid, 10%	EE	EE	EE	GG	EE

	LD-PE	HD-PE	PP	PS	PC
Lactose	EE	EE	—	E-	E-
Lead acetate	EE	EE	EE	EE	—
Mercury	EE	EE	EE	EE	E-
Methanol	EL	EE	EL	LU	UU
Mineral oil	LU	EL	EE	EE	GL
n-Amyl acetate	UU	LL	LL	UU	UU
Nitric acid, 10%	EE	EE	EE	EE	GL
Nitric acid, 50%	LU	LU	LU	UU	GL
Nitric acid, 70%	LU	LU	UU	UU	UU
n-Octane	UU	LU	LU	UU	E-
Oleic acid	LU	GG	GL	GG	EE
Oxalic acid	EE	EE	EE	EG	EE
Ozone	UU	LU	LL	UU	UU
Perchloroethylene	UU	UU	UU	UU	UU
Perchloric acid	GU	GU	GU	GL	UU
Phenol	LU	GG	GL	UU	UU
Phosphoric acid, 10%	EE	EE	EE	E-	LU
Phosphoric acid, 85%	EE	EE	EG	EL	UU
Phosphorus trichloride	UU	UU	GL	UU	UU
Potassium acetate	EE	EE	EE	EE	UU
Potassium bromide	EE	EE	EE	L-	EG
Potassium carbonate	EE	EE	EE	EE	GL
Potassium hydroxide, conc.	EE	EE	EE	GG	UU
Potassium permanganate	EE	EE	EE	LL	UU
Propylene glycol	EE	EE	EE	EE	GL
Pyridine	LU	GL	LU	UU	UU
Saccharose	EE	EE	EE	EE	—
Salicylic acid, sat.	EE	EE	EE	EG	EG
Silver acetate	EE	EE	EE	GG	—
Silver nitrate	EE	EE	EG	GL	EE
Sodium carbonate	EE	EE	EE	EE	GL
Sodium chloride, sat.	EE	EE	EE	EE	EE
Sodium dichromate	EE	EE	EE	EE	—
Sodium hydroxide, 1%	EE	EE	EE	GG	—
Sodium hydroxide, 50%	EE	EE	EE	GG	UU
Sodium hypochlorite, 15%	—	EE	E-	—	—
Sodium nitrate	EE	EE	EE	EE	LU
Sodium sulphate	EE	EE	EE	EE	E-
Sulphuric acid, 20%	EE	EE	EE	EG	EG
Sulphuric acid, 6%	EE	EE	EE	EE	EE
Sulphuric acid, 60%	EG	EE	EG	GU	LU
Sulphuric acid, 98%	LU	LU	LU	UU	UU
Tannic acid, 20%	EE	EE	EE	GG	UU
Tetrahydrofuran	UU	UU	LU	UU	UU
Toluene	UU	LU	LU	UU	UU
Trichloroacetic acid	LU	GL	LU	UU	L-
Trichloroethane	UU	LU	UU	UU	UU
Trichloromethane	UU	UU	LU	UU	UU
Turpentine oil	UU	UU	UU	UU	—
Urea	EE	EE	EE	EG	UU
Xylene	UU	UU	UU	UU	UU
Zinc chloride	EE	EE	EE	EE	EE

Legend

E = Excellent

Plastic is fully resistant to this substance.

G = Good

Long-term exposure to this substance causes no or little damage.

L = Limited

With constant exposure, plastic tends to develop hairline cracks, deteriorate in its mechanical strength or discolor.

U = Unstable

Plastic is unsuitable for use in conjunction with this substance. Use is not recommended.

—

No investigations available.

A

ABG (arterial blood gas)	46-47
Absorbent liners for mailing containers	68-70
Accessories for Sediplus®	43
Adapter for S-Monovette®	19
Adhesive films	106-107, 130-131, 133
Adhesive labels	89, 204
Aluminium foil, adhesive, for PCR and storage	107, 130
Amplification tubes/plates	121-129
Anesthesia	198-201
Anti-evaporation cap	26, 91
Archiving cap	25-26, 91
Areas of application and preparations	14-17
Aspiration pipette	150
Autologous direct retransfusion	197
Automatic-Sarpette®	151
Automation tubes	25-26

B

Battery-powered tube stripper	211
Bioreactor, miniPERM®	164-165
Biosphere® plus micro tubes	101
Biosphere® plus pipette tips	136-145
Biosphere® plus purity standard	94, 120, 136
Biosphere® plus screw cap micro tubes	95
Block racks	27, 115-116
Blood & infusion warmer	202-203
Blood collection, capillary	11, 36-40, 45-47
Blood collection, venous	8-21, 28-29, 42, 44
Blood culture adapter	19
Blood donation chair	216
Blood donation table	216
Blood filter	196
Blood gas analysis	46-47
Blood gas capillary	46-47
Blood gas Monovette®	46
Blood mixing and weighing device	208-209
Blood product transport	213-214
Blood sedimentation, capillary	45
Blood sedimentation instruments	42-44
Blood sedimentation racks	42, 44-45
Blood sedimentation, venous	42, 44
Box for postal shipping	66
Bulk Loader BL 2000	32
Butterfly needle, see Multifly® needle	18
Butterfly needle, see Multifly® needle	18
Bulk Loader BL 2000	32
Butterfly needle, see Multifly® needle	18

C

Capillary blood collection	11, 36-40, 45-47
Capillary blood gas analysis	46-47
Capillary holder	41
Capping/sealing films	106-107, 130-131, 133
Caps	25-26, 90-91, 103, 183
Carrier tube for Microvette®	21
Carrier tube for Multivette® 600	21
Carrier tube for S-Monovette®	21
Catheter quiver	205
Cell and tissue culture products	104-105, 155-171
Cell culture chambers, x-well	167

Cell culture dishes	158
Cell culture flasks	156-157
Cell culture plates	160-161, 166
Cell culture plates for fluorescence analyses	166
Cell culture tubes	171
Cell scrapers	159
Cell+ surface	155
Centrifuge MC 6	122
Centrifuge SMC 6, SMC 6plus, LC 24	30
Centrifuge tubes	51, 57, 60, 82-89, 171
Chamber slides, see x-well cell culture chambers	167
Chemical resistance table	221
Color-coded cap for STAT samples	20
Compatibility table for PCR plates	128-129
Compatibility table for pipette tips	142-145
Conical tubes	51, 57, 60, 85-87, 171
Conical tubes for Pharmacia/LKB gamma counter	23
Conical urine tubes	51
Containers	56-57, 108-109
Cool transport containers	70-71
Cooling rack	117
Cotton swab	132, 174
Cover foils/sealing tapes	106-107, 130-131, 133
Cover for block rack	27, 116
Coverslips, cell cultivation	160-161
CPDA1 S-Monovette®	17
Cryo Performance Tested	154
Cryoboxes	104, 110
CryoPure boxes	104, 110
CryoPure freezing system	104-105
CryoPure tubes	105
Cryotubes	104-105
CSE set	200
CSF Monovette®	60
CSF tubes	60
CTAD S-Monovette®	17
Cuvettes	131, 182-183

D

DC/RC 900 Flex	32
Decapper DC 1200	31
Deep Well MegaBlock® 96 well plates	107
Delivery pipette	150-151
Dilution pipettes	151
DishRack Petri dish stand	176
Dispenser box for long spatula	184
Dispenser box for tips, reaction tubes and other equipment	111
Disposable tourniquets	20
Disposal bags	185
Disposal boxes	72-76
DNA low binding micro tubes	96, 100
DNA low-binding screw cap micro tubes	96

E

ELISA plates	133
End-to-end capillary	41
Environmental technology (gas sampler, microbial air sampler)	178-179
Epidural anesthesia	200
Epidural needle	200

ESR	See blood sedimentation
ESR racks	42, 44-45

F

FACS tubes	82
False bottom tubes	25-26
Felt marker	184
Films for PCR and qPCR	106-107, 130-131
Filters	169-170
Filter tip, pipette tip with filter	137-140, 142-145
Filtration unit Filtropur S/L	170
flexiPERM® silicone inserts	168
Forensic swabs	132
Formalin system	61

G

Gamma counter tubes	23, 82
Gas sampler	178
Gel-loading pipette tips	141, 146
Glass tubes for Coombs test	82, 217
GlucoEXACT S-Monovette®	16

H

Haemo-Diff®	21
HAEM-o-TRANS	197
HCTS 2000 MK2	32
Hemolysis solution for glucose test	41
Hemoplus® set for stool tests	59
Hirudin S-Monovette®	17
HOLDERS for disposal boxes	76
Homocysteine S-Monovette®	16
Hooks for urine and secretion bag	188, 190

I

Incision lancet	40
Incontinence care	192-193
Inoculation loops	176
Inoculation needle	176
Inoculation spreader	176
Insertion plate for safety tray	77
Inserts	22
IsoFreeze® rack	117

L

Label dispenser	204
Labels	89, 204
Lid for Microtest/ELISA plates	106, 133
Lid strips for PCR	122, 126
Low binding micro tubes	96, 100
Low-binding screw cap micro tubes	96
Low retention pipette tips	138-139
lumox® dish	166
lumox® multiwell	166

M

Mailing packaging for cold transport	70-71
Mat covers for Deep Well MegaBlock®	107
Material properties of plastics	219
Measuring pipette	150-151
Medical/hospital products	186-205
Medicine cup	108
MegaBlock® deep well plates	107

Membrane adapter for blood gas Monovette®	19
Membrane adapter for Luer systems	19
Membrane pump	170
Membrane screw cap	98
Metal analysis S-Monovette®	16
Micro needles	28
Micro sample tubes, prepared	28, 41
Micro test plates	106, 133
Micro tubes	93-103
Microbial air samplers	179
Microvette® 100	36
Microvette® 200	36
Microvette® 300/500	37
Microvette® CB 200 ESR	45
Microvette® CB 300	38
miniPERM® bioreactor	164-165
Minivette® POCT	39
Mini-Vials	24
Mixers	43, 92
Monovette®	Aug 19
MS segmentation system	210
M-Sarpette®	151
Multi-adapter for S-Monovette®	19
Multidishes, cell culture	160-161, 166
Multify® needle	18-19
Multiply® PCR plates	123-129
Multiply® PCR tube	121-122
Multi-purpose cup with snap-on lid	56, 108
Multi-purpose tubes with screw cap	57, 109
Multi-Safe disposal boxes	72-76
Multisealer sealing device	210-211
Multivette® 600	38

N

Navel clamp	205
Needle disposal boxes	72-76
Needles for S-Monovette®	16, 18-19

P

Paper adhesive labels	89
Pasteur pipettes	148-149
PCR films/sealing tapes	107, 130-131
PCR lid strips	122, 126-127
PCR Performance Tested Purity Standard	94, 120, 136
PCR plates	123-129
PCR plates, white	123-124
PCR strips	121-122, 127
PCR tubes	121-122
Pediatric lancet	11, 40
Pediatric S-Monovette®	10, 14-15
Petri dish DishRack	176
Petri dish organization & transfer system	177
POS 720 • PTS	
Petri dishes	175
PFA S-Monovette®	17
Pipette tips	137-147
Pipette tips, Biosphere® plus quality	136-141
Pipette tips, low retention	138-139
Pipette tips refill	147
Pipette tips with filter	137-140, 142-145
Pipettes	148-151

Pipetting aids	151
Platelet incubator/agitator	215
Plexus anesthesia	201
Plexus catheter set	201
Plexus needle	201
Plexus needle for nerve stimulation	201
Preparations	14-17
Prepared micro sample tubes	28, 41
Prepared sample tubes	29
Pressure cuff	194-195
Pressure filtration system	170
Pressure infusion cuff	194-195
Protective vessel for postal shipping	67-69
Protein low-binding micro tubes	100
Protein low-binding screw cap micro tubes	96
Push cap	25-26, 90-91, 103, 183
Push inserts for caps, colored	84, 99, 105
PVS 1625	33
PVS sample sorter	33
Q	
quadriPERM® cell culture dish	168
R	
Racks	27, 99, 112-117
Racks for 50 ml centrifuge tubes	117
RackSystem for PCR	117, 127
Radiation indicator	216
Reaction & centrifuge tubes, conical base	51, 57, 60, 85-87, 171
Reaction & centrifuge tubes, conical skirted base	51, 57, 60, 85-87, 171
Reaction & centrifuge tubes, false bottom	25-26
Reaction & centrifuge tubes, flat base	88-89
Reaction & centrifuge tubes, print/label	25-26, 51, 57, 60, 82-89, 171
Reaction & centrifuge tubes, round base	25-26, 80-82, 171
Reaction & centrifuge tubes with cap	51, 80-82, 87, 89, 171
Reaction & centrifuge tubes with O-ring screw cap	84
Reaction & centrifuge tubes with screw cap	25-26, 51, 57, 60, 83-88, 171
Reaction tube Biosphere® plus	100-101
PCR performance tested	100-101
Reaction tube for microliter systems	100-103
Reaction tube for PCR, thin-walled	121-122
Reaction tube SafeSeal	100-101
Real-time PCR consumables	123-131
Recapper RC 1200	31
REGANESTH®	198-199, 201
Regional anesthesia	198-201
Regional anesthesia set	200
Reticulocyte counting	41
RIA tubes	24
Rotating workstation rack	117
Round cuvette	183
S	
SafeSeal micro tubes	100-101
Safety lancet	40
Safety needle	18-19
Safety Tray	77
Safety-Heel® incision lancet	40
Safety-Multifly® needle	18-19
SAHARA temperature control system	202-203
SAHARA-III	202
SAHARA-TSC	203
Salivette®	60
Sample storage boxes	111
Sample tubes for analyzer	22-24
Sample tubes with preparation	28, 41
Sarmix® GM 1	92
Sarmix® M 2000	43, 92
Sarmix® SM 1	92
Sarpette®	151
Scintillation vials	24
Screw cap tubes	25-26, 51, 57, 60, 83-88, 93-99, 171
Screw cap micro tubes	93-99
Sealing locks for blood bags	205
Sealing tongs	212
Secondary tubes	26
Secretion bag	190-191
Sedimentation pipette (Westergren)	44
Sedimentation stand	42, 44-45
Sediplus® accessories	42-45
Sediplus® ESR system	44
Sediplus® S 100	44
Sediplus® S 200	42
Sediplus® S 2000	42
Sedivette®	42
Semi-micro cuvette	182
Seraplas® V, serum/plasma filter	20
Serological pipettes	150-151
Shock-absorbing system for tube postal shipping	64
Shock-absorbing system for tube transport	64
Slide mailing container	71
Slide-based cell culture chambers	167
S-Monovette®	8-20, 26
Spatula	184
Spinal anesthesia	198-199
Spinal needle pencil-point	199
Spinal needle Quincke	199
Sputum tubes	57, 109
Square cuvettes	182-183
S-Sedivette®	42
Standard surface for adherent cells	155-161
Sterile filtration	169-170
Stirring rod	184
Stool test for occult blood	59
Stool tubes	58-59
Storage boxes	104, 110-111
Stripping tongs	212
Styrofoam container for sample transport	111
Styrofoam packaging for cool transport	70-71
SUREGrip dishes	158
Suspension culture surface	155-161
Swab	132, 174
Swab, DNA-free	132
Swab/smear utensil	174
Syringe filter	170
Syringe labeling	204
T	
Table rack for disposal bag	185
TC dishes	158
TC flasks	156-157

TC Inserts	162-163
TC plates	160-161, 166
TC plates for fluorescence analyses	166
TC products	104-105, 155-171
TC tubes	171
Tempering device for blood stem cell preparations	203
Tempering device for plasma & blood components	202
Terasaki micro test plate	106
Thrombo Plus®	41
ThromboExact S-Monovette®	17
Tip StackPack	147
Tip SystemBox	146
Tissue culture dishes	158
Tissue culture flasks	156-157
Tissue culture plates	160-161, 166
Tissue culture plates for fluorescence analyses	166
Tissue culture products for adherent cells	155-161
Tissue culture products for suspension and hybridoma cells	155-161
Tissue culture tubes	171
Tissue fixation	61
TOPSWING blood mixing weighing machine	208
TOPSWING PRO II	208
Tourniquet	20
Transfer pipettes	148-149
Transfusion devices	196
Transfusion medicine	194-197, 202-217
Transport box	66
Transport box for cool transport	66, 70-71
Transport containers for slides	71
Transport envelopes	65-66
Transport packaging for medical specimens	64-71
Transport tubes	67-69
Transportation systems	64-71
TRANSWAAG PRO	209
Tube segment opener TSO	217
Tubes for immunoanalytics	24
Tubes for PCR	121-129

U

Universal blood culture adapter	19
Universal caps	25-26, 91
Universal hooks for urine and secretion bags	188, 190
Universal rocking mixer SM 1	92
Urine and secretion bags	190-192
Urine collection bottles	53-55
Urine collection set	55
Urine container	53, 56-57
Urine container with screw cap	53-57, 109
Urine drainage systems	188-192
Urine leg bag	192
Urine measurement system UM 500	189
Urine Monovette®	50
UriSet 24	55
UroStretch	193
UV micro cuvette	131, 183

V

Vacuum filtration units	169
Vacuum pump	170
Velcro bands for leg bag	193

Venous blood collection	8-21, 28-29, 42, 44
Ventilation cap	82, 91
V-Monovette® Urine	52

W

Weighing trays	184
Westergren pipettes	44

X

x-well cell culture chambers	167
------------------------------	-----

Order number directory

Order No.	Page	Order No.	Page	Order No.	Page	Order No.	Page	Order No.	Page
01.1601.100	14	05.1071.100	15	14.1205.100	19	26.358.100	29	55.460	80
01.1602.001	14	05.1073.100	15	14.1207	19	26.367.100	29	55.461	80
01.1604.100	14	05.1074.001	16	14.1209	19	26.369.100	29	55.463	80
01.1604.400	16	05.1079.100	44	14.1217	21	32.329.100	29	55.465	80
01.1605.100	15	05.1081.100	15	14.1218	21	32.332.100	29	55.466	80
01.1606.100	15	05.1104.100	14	14.1513	20	32.333.100	29	55.466.005	80
01.1608.100	14	05.1106.100	14	14.1513.001	20	36.336.100	29	55.467.006	80
01.1613.100	15	05.1146	46	14.1513.002	20	36.338.100	29	55.467.300	80
01.1621.100	15	05.1146.020	46	14.1513.005	20	38.346.100	29	55.468	80
01.1634.100	14	05.1147	46	14.1513.008	20	41.1178.903	41	55.468.001	81
01.1728.001	16	05.1147.020	46	15.1670.100	38	41.1350.105	28	55.468.005	80
03.1068.100	15	05.1147.028	46	15.1671.100	38	41.1378.005	28	55.471	80
03.1397.100	14	05.1147.048	46	15.1672.100	38	41.1392.105	28	55.472	80
03.1524.001	14	05.1165.100	15	15.1673.100	38	41.1393.105	28	55.473	80
03.1628.100	14	05.1167.100	15	15.1674	38	41.1394.105	28	55.474	80
03.1631.100	14	05.1553.100	14	15.1675.100	38	41.1395.105	28	55.475.001	81
04.1900.100	15	05.1557.100	14	16.434.100	38	41.1438.901	41	55.475.200	82
04.1901.100	15	05.1727.001	16	16.440.100	38	41.1438.904	41	55.475.300	81
04.1902.100	15	05.1729.001	16	16.441.100	38	41.1443.904	41	55.475.305	81
04.1903.100	15	06.1660.100	15	16.443.100	38	41.1496.911	41	55.476.013	82, 171
04.1904.100	14	06.1663.100	14	16.444.100	38	41.1500.005	28	55.476.061	82
04.1905.001	14	06.1664.100	15	16.446.100	38	41.1501.105	28	55.476.300	81, 217
04.1906.100	14	06.1665.100	15	17.2111.010	39	41.1503.105	28	55.476.305	81, 217
04.1907.100	14	06.1666.100	14	17.2111.020	39	41.1504.105	28	55.481	80
04.1908.001	16	06.1667.001	14	17.2111.050	39	41.1505.105	28	55.482	80
04.1909.100	17	06.1668.100	15	17.2111.100	39	41.1506.100	28	55.484	81
04.1910.001	17	06.1669.100	14	17.2111.200	39	41.1506.102	28	55.484.001	81
04.1913.100	15	06.1690.100	42	17.2111.920	39	41.1506.105	28	55.484.005	81
04.1914.100	15	09.1704.001	61	17.2112.101	39	41.3395.105	28	55.495	80
04.1915.100	15	09.1705.001	61	17.2112.120	39	42.117	41	55.510	80
04.1917.100	15	10.250.001	50	17.2112.150	39	45.498.003	29	55.511	80
04.1918.100	15	10.251	50	17.2112.201	39	47.409.001	29	55.514	80
04.1919.100	15	10.252	50	17.2113.120	39	47.410.100	44	55.515	80
04.1920.100	14	10.252.020	50	17.2113.150	39	51.334	41	55.516.300	80
04.1922.100	15	10.252.027	60	18.1325.100	45	51.931.100	47	55.517	80
04.1923.001	14	10.252.028	50	19.414	41	51.931.125	47	55.518	80
04.1924.100	14	10.252.030	50, 55	19.447	41	51.931.140	47	55.522.300	80
04.1925.001	14	10.253	50	20.1278.100	36	51.931.175	47	55.524	80
04.1926.001	16	10.253.001	50	20.1280.100	36	51.1444.001	59	55.525	81
04.1927.100	14	10.253.020	50	20.1282.100	36	51.1534	60	55.525.005	21, 81
04.1928.100	14	10.253.021	50	20.1288.100	36	51.1534.500	60	55.525.302	21
04.1929.100	14	10.258	50	20.1289.100	36	51.1638.945	19	55.526.006	82, 171
04.1931.100	15	10.258.020	50	20.1290.100	36	51.1640.945	19	55.526.053	82
04.1932.100	15	11.1240	53	20.1291	36	51.1703	61	55.526.300	81
04.1934.100	14	11.2252.001	52	20.1292.100	36	51.1703.009	61	55.526.305	81
04.1935.001	14	11.2253.001	52	20.1307.100	37	51.1703.025	61	55.528	81
04.1936.100	14	11.2352.001	52	20.1308.100	37	51.9923.820	51	55.533	80
04.1939.100	14	11.2452.001	52	20.1309.100	37	53.419	20	55.535.300	81
04.1940.100	14	11.2453.001	52	20.1341.102	37	53.420	20	55.538	80
04.1943.100	14	11.2552.001	52	20.1343.100	37	53.428	20	55.539	80
04.1945.001	16	14.1112	19, 46	20.1344	37	53.677	20	55.539.250	80
04.1955.100	15	14.1148	46	20.1345.100	37	53.1030	20	55.598.006	80
04.1959.001	17	14.1205	19	20.1346.100	37	55.459	80	55.655	81

Order number directory

Order No.	Page	Order No.	Page	Order No.	Page	Order No.	Page	Order No.	Page
55.1570	21	60.546.002	83	62.547.100	85, 171	65.676.001	68	65.782	81, 91
55.1570.002	21	60.549	87, 111	62.547.205	85, 171	65.678	69	65.790	80, 89, 90
55.1571	21	60.549.001	87	62.547.275	85	65.679	68	65.791	80, 90
55.1571.051	21	60.550	88	62.547.354	85	65.679.001	68	65.793.300	51, 80, 87, 89, 90, 183
55.1572	21	60.550.009	88	62.548.101	85	65.679.002	68	65.793.313	90
55.1577	21	60.550.034	83	62.548.304	85	65.679.004	68	65.793.314	90
55.1577.002	21	60.550.049	83	62.551.201	84	65.697	103	65.793.315	90
55.1578	82	60.551	84	62.553.001	51, 85	65.710	96	65.793.317	90
55.1579	82	60.551.001	84	62.553.002	85	65.712	99	65.793.318	90
55.1579.002	82	60.557	83	62.553.020	60, 85	65.713	99	65.793.320	90
57.462.001	51, 87	60.557.011	83	62.553.205	51, 85	65.713.002	99	65.802	80, 90
57.462.015	51, 87	60.558	87	62.554.016	85	65.713.004	99	65.803.300	26, 80, 90, 183
57.462.300	51, 87	60.558.001	87	62.554.100	85, 171	65.713.005	99	65.803.302	90
57.477	51, 87	60.596	88, 109	62.554.101	51, 85	65.713.006	99	65.803.305	90
57.477.500	23, 82	60.596.001	88, 109	62.554.205	51, 85, 171	65.713.007	99	65.803.312	90
57.512	51, 87	60.597	88, 109	62.555	88, 109	65.713.009	99	65.803.332	90
57.527.300	51, 87	60.597.001	88, 109	62.555.001	88, 109	65.713.010	99	65.804.001	81, 90
58.485.001	89	60.610	26, 83	62.558.201	87	65.714	83	65.804.300	80, 90
58.485.300	89	60.610.001	83	62.559.010	85	65.716	98	65.806.300	25, 80, 81, 91
58.487	89	60.610.300	83	62.559.101	85, 171	65.716.001	98	65.806.306	91
58.489	89	60.611.310	26	62.559.205	85	65.716.002	98	65.806.307	91
58.490	89	60.611.311	26	62.610.018	60	65.716.003	98	65.806.308	91
58.491.300	89	60.612.310	26	62.610.201	83	65.716.004	98	65.806.310	91
58.505.300	89	60.613.010	25	62.611.300	26	65.716.005	98	65.806.311	91
58.536.300	89	60.614.010	25	62.612.300	26	65.716.006	98	65.806.312	91
58.537	89	60.614.011	25	62.613	25	65.716.007	98	65.809.300	51, 81, 82, 87, 91
58.631	89	60.614.015	25	62.617	25	65.716.008	98	65.809.301	91
60.503.010	26	60.617.010	25	62.732.519	86	65.716.009	98	65.809.302	91
60.504.021	26, 83	60.732	57, 86	62.9924.272	51, 87	65.716.022	98	65.809.303	91
60.504.022	26, 83	60.732.001	57, 86	62.9924.293	51, 85	65.716.720	98	65.809.304	91
60.506	83	60.9921.821	51, 86	62.9924.294	51, 85	65.716.721	98	65.809.305	91
60.506.001	83	60.9921.829	51, 86	63.542.709	88	65.716.723	98	65.809.306	91
60.507	85	60.9921.830	51, 86	63.9922.248	60, 86	65.716.725	98	65.809.307	91
60.540.108	84	60.9922.113	88	63.9922.252	57, 86	65.716.726	98	65.816	51, 80, 87, 89, 90
60.540.314	84	60.9922.115	88	63.9922.254	57, 86	65.716.727	98	65.818	80, 81, 91
60.540.316	84	60.9922.212	88	65.108	24	65.716.728	98	65.935.205	47
60.540.322	84	60.9922.241	57, 86	65.163	25	65.716.729	98	65.935.230	47
60.540.352	84	60.9922.243	57, 86	65.163.303	26, 83	65.716.755	98	65.989	122, 127
60.540.386	84	60.9922.936	83	65.177.039	83	65.716.757	98	65.989.002	122
60.540.500	84	60.9922.937	83	65.386	105	65.716.999	98	65.1121	13, 83
60.541.300	84	60.9924.952	60	65.386.002	105	65.719	51, 81, 82, 87, 91	65.1375	24
60.541.303	84	62.470.300	89	65.386.004	105	65.720	51, 80, 87, 89, 90	65.1379	25, 26, 91
60.541.304	84	62.476.028	82, 171	65.386.005	105	65.722	82, 91	65.1379.002	26, 91
60.541.321	84	62.476.322	81	65.386.006	105	65.723	103	65.1379.004	26, 91
60.541.385	84	62.486.300	89	65.386.007	105	65.724	80, 81, 91	65.1379.005	26, 91
60.541.545	84	62.492	80	65.386.992	105	65.725	80, 82, 91	65.1379.006	26, 91
60.541.929	84	62.493.300	81	65.529	80, 90	65.727	80, 90	65.1379.007	26, 91
60.542.300	88	62.515.006	82, 171	65.645	26	65.728	13, 25, 26	65.1379.008	26, 91
60.542.307	88	62.515.028	82, 171	65.647	25, 26, 91	65.729.300	13, 26, 83	65.1379.010	91
60.542.324	88	62.526.028	82, 171	65.647.020	25, 26, 91	65.731	68		
60.544	85	62.543	57, 86	65.648	26, 91	65.744.999	84		
60.545	85	62.543.001	57, 86	65.649	22				
60.546	83	62.543.030	55	65.676	68				

Order number directory

Order No.	Page	Order No.	Page	Order No.	Page	Order No.	Page	Order No.	Page
65.1998.400	126	70.1114.105	139	72.380	105	72.692.005	97	72.703.700	96
65.3716	98	70.1114.200	141	72.380.002	105	72.692.100	99	72.704	101
67.738	182	70.1114.210	140	72.380.004	105	72.692.105	99	72.704.001	101
67.740	182	70.1114.215	139	72.380.005	105	72.692.210	95	72.704.002	101
67.741	182	70.1114.410	140	72.380.006	105	72.692.405	95	72.704.004	101
67.742	182	70.1116	141	72.380.007	105	72.692.415	95	72.704.005	101
67.743	183	70.1116.100	141	72.380.992	105	72.693	98	72.704.006	101
67.745	182	70.1116.105	139	72.383	105	72.693.005	98	72.704.200	101
67.746	182	70.1116.200	141	72.383.002	105	72.693.100	99	72.704.400	101
67.749	183	70.1116.210	140	72.383.004	105	72.693.105	99	72.704.600	100
67.754	182	70.1116.215	139	72.383.005	105	72.693.465	95	72.704.700	100
67.755	182	70.1130	141	72.383.007	105	72.694	98	72.706	101
67.758	131, 183	70.1130.100	141	72.383.992	105	72.694.005	98	72.706.001	101
67.758.001	131, 183	70.1130.105	139	72.607	97	72.694.006	98	72.706.002	101
67.759	131, 183	70.1130.200	141	72.607.772	98	72.694.007	98	72.706.004	101
67.759.001	131, 183	70.1130.210	140	72.608	98	72.694.100	99	72.706.005	101
68.752	183	70.1130.212	140	72.609	98	72.694.105	99	72.706.006	101
70.760.001	141	70.1130.215	139	72.609.001	98	72.694.106	99	72.706.200	101
70.760.002	141	70.1130.217	139	72.609.003	98	72.694.107	99	72.706.201	101
70.760.012	141	70.1130.410	140	72.609.711	98	72.694.217	95	72.706.400	101
70.760.102	141	70.1130.460	141, 147	72.664	97	72.694.406	95	72.706.600	100
70.760.107	139	70.1130.600	141, 147	72.664.711	98	72.694.416	95	72.706.700	100
70.760.201	141	70.1183.001	141	72.687	97	72.694.600	96	72.708	103, 113
70.760.202	141	70.1183.002	141	72.687.772	98	72.694.700	96	72.709	103
70.760.211	140	70.1183.101	141	72.688	103	72.694.996	98	72.730	97
70.760.212	140	70.1183.102	141	72.688.001	103	72.695.001	101	72.730.003	97
70.760.213	140	70.1186	141	72.688.002	103	72.695.002	101	72.730.004	97
70.760.216	139	70.1186.100	141	72.688.003	103	72.695.004	101	72.730.005	97
70.760.217	139	70.1186.200	141	72.688.004	103	72.695.005	101	72.730.006	97
70.760.219	139	70.1186.210	140	72.688.005	103	72.695.006	101	72.730.007	97
70.760.411	140	70.1186.410	140	72.689	103	72.695.007	101	72.730.009	97
70.760.412	140	70.1187.001	141	72.689.001	103	72.695.200	101	72.730.100	99
70.760.413	140	70.1187.101	141	72.689.002	103	72.695.201	101	72.730.105	99
70.760.451	141, 147	70.1189.105	141	72.689.003	103	72.695.400	101	72.730.106	99
70.760.452	141, 147	70.1189.215	140	72.689.004	103	72.695.500	101, 113	72.730.107	99
70.760.501	141, 147	70.1190.100	141, 146	72.689.006	103	72.695.600	100	72.730.217	95
70.760.502	141, 147	71.9923.210	184	72.690.001	112, 113, 114	72.695.700	100	72.730.406	95
70.762	141	71.9923.211	184	72.690.301	102	72.696	103, 112, 113, 114	72.730.416	95
70.762.010	141	71.9923.212	184	72.690.304	102	72.698	102	72.730.600	96
70.762.100	141	71.9923.610	88	72.690.307	102	72.698.200	103	72.730.700	96
70.762.105	139	72.377	105	72.690.375	102	72.699	102, 114	72.730.711	98
70.762.200	141	72.377.002	105	72.690.376	102	72.699.001	102	72.733.001	97
70.762.211	140	72.377.004	105	72.690.377	102	72.699.002	102	72.733.010	97
70.762.216	139	72.377.005	105	72.690.378	102	72.699.003	102	72.733.201	96
70.762.411	140	72.377.007	105	72.690.550	102	72.699.004	102	72.735.002	114, 121
70.765	141	72.377.992	105	72.691	102	72.699.005	102	72.735.100	121
70.765.100	141	72.379	105	72.691.001	102	72.703	97	72.735.992	121
70.765.105	139	72.379.002	105	72.691.002	102	72.703.004	97	72.737	121
70.765.200	141	72.379.004	105	72.691.004	102	72.703.217	95	72.737.002	121
70.765.210	140	72.379.005	105	72.691.005	102	72.703.406	95	72.737.992	121
70.765.215	139	72.379.006	105	72.691.006	102	72.703.416	95	72.785	97
70.1114	141	72.379.007	105	72.691.007	102	72.703.600	96	72.785.005	97
70.1114.100	141	72.379.992	105	72.692	97			72.982.002	122

Order number directory

Order No.	Page	Order No.	Page	Order No.	Page	Order No.	Page	Order No.	Page
72.982.092	122	74.5206.005	191	75.1337.500	108	77.3894.050	74	79.8083.100	200
72.985	127	74.5207.005	191	75.1337.502	108	77.3895.005	74	79.8083.110	200
72.985.002	122	74.5210.001	190	75.1337.504	108	77.3895.007	74, 77	79.8083.500	200
72.985.092	122	74.5210.101	190	75.1337.505	108	77.3895.017	74	79.8086.000	200, 201
72.985.992	122	74.5220.001	190	75.1337.506	108	77.3895.021	74	79.8086.050	200, 201
72.991.102	121	74.5220.005	190	75.1355	56, 108	77.3895.030	74	79.8088.920	200
72.991.103	121	74.5220.101	190	75.1355.100	77	77.3897.030	74	79.8089.150	200
72.994.002	122	74.5230.001	192	75.1356	55, 56	77.3897.040	74	79.8089.210	200
72.994.992	122	74.5230.005	192	75.1435.004	57	77.3897.060	74	79.8091.000	201
72.1978.202	125	74.5230.101	192	75.9922.420	109	77.3897.070	74	79.8092.005	201
72.1978.232	124	74.5231.001	192	75.9922.421	109	77.3898.006	75	79.8092.200	201
72.1979.102	125	74.5231.005	192	75.9922.518	109	77.3898.011	75	79.8093.200	201
72.1979.132	124	74.5231.101	192	75.9922.532	109	77.3898.106	75	79.8095.050	201
72.1979.202	125	74.5330	188	75.9922.534	109	77.3898.111	75	79.8095.070	201
72.1979.203	125	74.5330.010	188	75.9922.721	57, 109	77.3898.206	75	79.8095.120	201
72.1980.202	126	74.5335	188	75.9922.744	57, 109	77.3899.025	75	79.8096.050	201
72.1980.232	124	74.5335.010	188	75.9922.745	57, 109	77.3899.035	76	79.8096.080	201
72.1981.202	126	74.5340	188	75.9922.812	109	77.3899.050	75	79.8096.188	201
72.1981.232	124	74.5340.001	188	75.9922.813	109	77.3899.060	76	79.8200.000	196
72.1982.202	124	74.5350	188, 190	75.9922.818	109	77.3899.125	75	79.8200.100	196
72.1984.202	125	74.5455.005	190	76.561	56, 108	77.3899.150	75	79.8200.440	196
72.1985.202	124	74.5610.100	189	76.564	57, 109	78	70	79.8200.490	196
73.641	22	74.5610.200	189	76.571	56, 108	78.572	67	79.8200.500	196
73.646	22	74.5620.200	189	76.1340.500	108	78.573	67	79.8300.557	204
73.650.500	22	74.5622.005	189	76.1340.560	108	78.574	67	79.8300.558	204
73.663	24	74.5624.005	189	76.1414	56, 108	78.574.500	67	79.8360.003	204
73.666	22	74.5630.200	189	76.1414.100	56, 108	78.669	69	79.8360.004	204
73.667	22	74.5650.010	189	76.1477	56, 108	78.670	68	79.8400.100	197
73.680	24	74.5760	190	76.1477.100	56, 108	78.684	68	79.8400.203	197
73.834	23	74.5766.001	193	77.575.001	53, 54	78.890	68	79.8400.220	197
73.910	23	74.5766.002	193	77.575.401	53, 54	78.892	68	79.8400.230	197
73.910.001	23	74.5766.003	193	77.577	54	78.895	69	79.8400.270	197
73.910.002	23	74.5767.001	193	77.578	55	78.896	68	79.8673.901	216
73.910.003	23	74.5767.002	193	77.578.010	55	78.897	69	79.8701.990	205
73.910.004	23	74.5767.003	193	77.578.252	55	78.898	68	79.8710.575	202, 203
73.1051	22	74.5767.004	193	77.580	53, 54	79.8043.910	200	79.8710.576	202, 203
73.1052	22	74.5810.005	192	77.582	54	79.8081.210	199	79.8710.610	203
73.1052.001	22	74.5810.101	192	77.3890.002	73	79.8081.500	199	80.620	58
73.1053	22	74.5815.005	192	77.3890.003	73	79.8081.503	199	80.621	58
73.1055	24	74.5815.101	192	77.3891.005	73	79.8081.510	199	80.622	58
74.4701	205	74.5820.005	192	77.3891.010	73	79.8081.515	199	80.622.111	58
74.5201.001	191	74.5820.101	192	77.3891.015	73	79.8081.520	199	80.623	58
74.5201.005	191	74.5825.005	192	77.3891.020	73	79.8081.530	199	80.623.022	58
74.5201.101	191	74.5825.101	192	77.3891.025	73	79.8081.540	199	80.623.111	58
74.5202.001	191	75.560	56, 108	77.3892.015	73	79.8081.800	199	80.625	174
74.5202.005	191	75.562.005	57, 109	77.3892.020	73	79.8081.803	199	80.629	132
74.5202.101	191	75.562.011	57	77.3892.025	73	79.8081.805	199	80.629.001	132
74.5203.001	191	75.562.105	57, 109	77.3893.015	73, 77	79.8081.811	199	80.629.101	132
74.5203.005	191	75.562.300	57, 109	77.3893.023	73	79.8081.812	199	80.630	132
74.5203.101	191	75.562.400	53	77.3894.007	74	79.8081.840	199	80.634	132
74.5204.001	191	75.563	57, 109	77.3894.018	74, 77	79.8081.900	199	80.734	58
74.5204.005	191	75.565	56, 108	77.3894.021	74	79.8081.940	199	80.734.001	58
74.5204.101	191	75.570	56, 108	77.3894.030	74	79.8082.210	199	80.734.301	58

Order number directory

Order No.	Page	Order No.	Page	Order No.	Page	Order No.	Page	Order No.	Page
80.734.311	58	83.1831	159	83.3924	161	84.1556.010	89	86.1201	185
80.734.401	58	83.1832	159	83.3924.005	161	85.921	28	86.1201.103	185
80.1301.500	174	83.1840	161	83.3924.300	161	85.923	28	86.1202	185
80.1303.500	174	83.1840.001	161	83.3924.500	161	85.925	28	86.1202.103	185
80.1361.500	174	83.1840.002	161	83.3925	161	85.1015	40	86.1203	185
80.1362.500	174	83.1850.600	170	83.3925.500	161	85.1016	40	86.1203.103	185
80.1363.500	174	83.3900	158	83.3926	161	85.1017	40	86.1204	185
80.1366.500	174	83.3900.002	158	83.3926.500	161	85.1018	40	86.1206.103	185
80.9924.014	59	83.3900.300	158	83.3930.040	163	85.1019	40	86.1251.001	150
80.9924.027	59	83.3900.500	158	83.3930.041	163	85.1022	40	86.1251.025	150
81.970	184	83.3901	158	83.3930.101	163	85.1023	40	86.1252.001	150
81.971	184	83.3901.002	158	83.3930.300	163	85.1160.200	18	86.1252.011	150
82.1135.500	175	83.3901.300	158	83.3930.500	163	85.1162.200	18	86.1252.025	150
82.1184.500	175	83.3901.500	158	83.3930.800	163	85.1162.600	16	86.1253.001	150
82.1194.500	175	83.3902	158	83.3931.040	163	85.1372.200	18	86.1253.025	150
82.1195	175	83.3902.300	158	83.3931.041	163	85.1373.200	18	86.1254.001	150
82.1472	175	83.3902.500	158	83.3931.101	163	85.1440.200	18	86.1254.025	150
82.1472.001	175	83.3903	158	83.3931.300	163	85.1441.200	18	86.1256.001	150
82.1473	175	83.3903.300	158	83.3931.500	163	85.1637.205	18	86.1509	82, 217
82.1473.001	175	83.3910	157	83.3931.800	163	85.1637.235	18	86.1562.010	176
82.1473.020	175	83.3910.002	157	83.3932.040	163	85.1638.200	18	86.1562.050	176
82.1473.040	175	83.3910.300	157	83.3932.041	163	85.1638.201	18	86.1567.010	176
82.1473.060	175	83.3910.302	157	83.3932.101	163	85.1638.205	18	86.1567.050	176
82.1473.080	175	83.3910.500	157	83.3932.300	163	85.1638.235	18	86.1568.010	176
82.1581	106	83.3910.502	157	83.3932.500	163	85.1638.935	19	86.1568.050	176
82.1581.001	106	83.3911	157	83.3932.800	163	85.1640.205	18	86.1569.001	176
82.1581.100	133	83.3911.002	157	83.3940	169	85.1640.235	18	86.1569.005	176
82.1581.110	133	83.3911.300	157	83.3940.001	169	85.1642.205	18	86.1685.001	150
82.1581.120	133	83.3911.302	157	83.3940.005	169	85.1642.235	18	86.1685.020	150
82.1581.200	133	83.3911.500	157	83.3940.100	169	86.972	71	86.1686.025	151
82.1581.210	133	83.3911.502	157	83.3940.101	169	86.972.150	71	86.1686.225	151
82.1581.220	133	83.3912	157	83.3941	169	86.974	65	86.1687.010	151
82.1582	106	83.3912.002	157	83.3941.001	169	86.1170.300	148	86.1688.010	151
82.1582.001	106	83.3912.300	157	83.3941.002	169	86.1171.020	149	86.1996	44
82.1582.100	133	83.3912.302	157	83.3941.005	169	86.1171.300	148	86.1996.062	44
82.1582.200	133	83.3912.500	157	83.3941.100	169	86.1171.301	149	87.7708.800	210
82.1583	106	83.3912.502	157	83.3941.101	169	86.1172.020	149	87.7708.813	210
82.1583.001	106	83.3920	161	83.3941.102	169	86.1172.300	148	87.7708.814	210
82.1583.100	133	83.3920.005	161	83.3942	169	86.1172.301	149	87.7708.815	210
82.1583.200	133	83.3920.300	161	83.3942.001	169	86.1173.001	149	87.7708.823	210
82.1584	106, 133	83.3920.500	161	83.3942.005	169	86.1173.020	149	87.7708.824	210
82.1586	106, 107, 133	83.3921	161	83.3942.100	169	86.1173.300	148	87.7708.825	210
82.1969.002	107	83.3921.005	161	83.3942.101	169	86.1174.020	149	87.7708.833	210
82.1970.002	107	83.3921.300	161	83.3990.025	157	86.1174.300	148	87.7708.834	210
82.1971.002	107	83.3921.500	161	83.3990.075	157	86.1175.020	149	87.7708.835	210
82.1972.002	107	83.3922	161	83.3990.175	157	86.1175.300	148	87.7708.850	211
82.9923.422	175	83.3922.005	161	83.9923.929	171	86.1176.300	148	87.7708.860	211
83.1826	170	83.3922.300	161	83.9923.943	171	86.1179.300	148	87.7708.909	215
83.1826.001	170	83.3922.500	161	83.9923.945	171	86.1180	148	87.7708.910	215
83.1826.102	170	83.3923	161	83.9923.972	106	86.1197	185	87.7708.911	215
83.1827	170	83.3923.005	161	84.1027.010	89	86.1198	185	87.7708.913	215
83.1827.001	170	83.3923.300	161	84.1402.001	53, 54	86.1199	185	87.7708.914	215
83.1830	159	83.3923.500	161	84.1412.033	66	86.1200	185	87.7708.915	215

Order number directory

Order No.	Page	Order No.	Page	Order No.	Page	Order No.	Page	Order No.	Page
87.7708.916	215	92.180.613	92	93.852.200	116	93.1646	176	94.6140.802	167
87.7709.025	212	92.180.614	92	93.852.300	116	93.1646.001	176	94.6150.101	167
87.7709.029	212	92.180.615	43, 92	93.853	27, 115	93.1646.002	176	94.6150.201	167
87.7709.031	212	92.180.616	92	93.853.131	27, 115	93.1646.003	176	94.6150.401	167
87.7709.032	212	92.180.617	92	93.853.132	27, 115	93.1646.004	176	94.6150.801	167
87.7709.033	212	92.180.618	92	93.853.133	27, 115	93.1646.080	176	94.6170.002	167
87.7709.035	212	92.180.619	92	93.853.134	27, 115	93.1647	176	94.6170.102	167
88.7708.095	212	92.181.410	92	93.853.135	27, 115	93.1647.001	176	94.6170.202	167
88.7740.102	215	92.184.551	30	93.853.200	116	93.1647.002	176	94.6170.402	167
88.7740.103	215	92.184.552	30	93.853.300	116	93.1647.003	176	94.6170.802	167
88.7740.109	215	92.184.553	30	93.854	27, 87, 115	93.1647.004	176	94.6190.002	167
88.7750.400	216	92.184.554	30	93.854.121	27, 115	93.1647.050	176	94.6190.102	167
88.7750.415	216	92.184.555	30	93.854.122	27, 115	93.1650	77	94.6190.202	167
88.7801.149	217	92.184.751	30	93.854.123	27, 115	93.1650.010	77	94.6190.402	167
88.7801.933	217	92.184.752	30	93.854.124	27, 115	93.1650.020	77	94.6190.802	167
90.170.180	178	92.184.755	30	93.854.125	27, 115	93.1650.030	77	95.64.213	111
90.170.185	178	92.186.110	122	93.857	27, 116	93.1650.040	77	95.64.249	111
90.170.300	178	92.186.111	122	93.868	114	93.1650.050	77	95.64.250	111
90.170.310	178	92.186.112	122	93.870	112	93.1707	117	95.64.251	111
90.170.350	178	92.186.113	122	93.872.225	104, 110	94.6000.014	166	95.064.259	111
90.170.370	179	92.189.121	151	93.872.425	104, 110	94.6000.024	166	95.64.916	111
90.180.600	43, 92	92.189.915	43	93.872.625	104, 110	94.6000.034	166	95.64.922	111
90.181.401	92	92.1417.001	151	93.873.281	104, 110	94.6001.036	165	95.64.923	111
90.181.402	92	92.1417.002	151	93.873.481	104, 110	94.6001.054	165	95.64.924	111
90.181.403	92	93.48.011	114	93.873.681	104, 110	94.6001.055	165	95.64.981	111
90.184.561	30	93.826	112	93.874.210	104, 110	94.6001.059	165	95.64.982	111
90.184.661	30	93.827	112	93.874.410	104, 110	94.6001.061	165	95.64.997	111
90.184.701	30	93.827.013	112	93.874.610	104, 110	94.6001.094	165	95.66.259	111
90.186.101	122	93.837	114	93.875.281	104, 110	94.6001.153	165	95.813.001	77
90.188.055	43	93.838	114	93.875.481	104, 110	94.6011.436	168	95.900	66
90.189.700	42	93.838.013	114	93.875.681	104, 110	94.6032.039	168	95.901	66
90.189.710	42	93.841.100	113	93.876	110	94.6034.067	168	95.902	66
90.189.725	43	93.844.100	113	93.876.281	110	94.6077.017	165	95.903	66, 70
90.189.730	43	93.846.100	113	93.876.381	110	94.6077.037	165	95.936	47
90.189.750	43	93.848.100	99, 113	93.876.481	110	94.6077.041	165	95.937	47
90.189.800	44	93.849.100	113	93.876.581	110	94.6077.121	165	95.950	184
90.189.900	42	93.850	112	93.876.681	110	94.6077.136	165	95.953	184
90.1060	44	93.850.001	112	93.877	110	94.6077.137	165	95.954	184
90.1060.062	44	93.851	27, 77, 116	93.877.210	110	94.6077.138	165	95.955	184
90.1090	42	93.851.171	27, 77, 116	93.877.310	110	94.6077.305	166	95.956	184
90.1091	45	93.851.172	27, 77, 116	93.877.410	110	94.6077.307	168	95.963	76
90.1416	151	93.851.173	27, 77, 116	93.877.510	110	94.6077.331	166	95.963.001	76
90.1427	151	93.851.174	27, 77, 116	93.877.610	110	94.6077.333	166	95.963.003	76
91.189.715	43	93.851.175	27, 77, 116	93.879	117	94.6077.410	166	95.963.004	76
92.170.352	178	93.852	27, 116	93.880	110	94.6077.434	168	95.963.015	76
92.170.353	178	93.852.168	27, 116	93.881	110	94.6077.435	168	95.963.023	76
92.170.354	178	93.852.169	27, 116	93.893.100	113	94.6110.024	166	95.965.001	76
92.170.356	178	93.852.170	27, 116	93.894	99, 112	94.6120.096	166	95.965.003	76
92.170.375	179	93.852.171	27, 116	93.1097.100	113	94.6130.384	166	95.983	117
92.170.390	179	93.852.172	27, 116	93.1102.001	113	94.6140.002	167	95.984	117
92.180.610	92	93.852.173	27, 116	93.1428	99, 114	94.6140.102	167	95.987.002	127
92.180.611	92	93.852.174	27, 116	93.1431	114	94.6140.202	167	95.988	127
92.180.612	92	93.852.175	27, 116	93.1431.001	114	94.6140.402	167	95.988.001	127

Order number directory

Order No.	Page	Order No.	Page	Order No.	Page
95.988.002	127	97.8100.011	195	97.8710.501	202
95.988.003	127	97.8100.100	195	97.8710.502	202
95.988.004	127	97.8100.102	195	97.8710.550	202
95.997	71	97.8100.111	195	97.8710.570	202, 203
95.1000	217	97.8100.200	195	97.8710.580	202
95.1000.100	217	97.8100.210	195	97.8710.590	202
95.1000.476	217	97.8100.211	195	97.8710.602	203
95.1000.800	217	97.8100.410	195	97.8710.620	203
95.1005	20	97.8100.600	194	97.8710.802	202
95.1006	20	97.8100.610	194	97.8750.000	214
95.1007.101	20	97.8100.620	194	97.8750.001	214
95.1011	70	97.8100.630	194	97.8750.010	214
95.1048	41	97.8100.631	194	97.8750.011	214
95.1123	70	97.8100.632	194	97.8750.015	214
95.1297	185	97.8100.633	194	97.8750.016	214
95.1298.001	146	97.8100.634	194	97.8750.018	214
95.1410	66	97.8100.635	194	97.8750.019	214
95.1411	66	97.8300.400	205	97.8750.020	214
95.1439	111	97.8300.450	205	97.8750.021	214
95.1706	61	97.8300.460	205	97.8750.050	214
95.1710	66	97.8300.500	204	97.8750.140	214
95.1712	65	97.8300.501	204	97.8750.141	214
95.1713	65	97.8300.600	205	97.8750.142	214
95.1714	65	97.8300.601	205	97.8750.143	214
95.1715	65	97.8300.610	205	97.8750.151	213
95.1717	65	97.8700.105	209	97.8750.153	213
95.1717.003	65	97.8700.233	209	97.8750.154	213
95.1717.011	65	97.8700.238	209	97.8750.156	213
95.1720	64	97.8700.239	209	97.8750.157	213
95.1720.011	64	97.8700.243	209	97.8750.160	213
95.1725	65	97.8700.261	209	97.8750.161	213
95.1760.011	146	97.8700.275	209	97.8800.200	212
95.1760.022	146	97.8700.310	216		
95.1760.034	146	97.8700.330	216		
95.1760.044	146	97.8700.335	216		
95.1762	147	97.8700.410	208		
95.1763	147	97.8700.420	208		
95.1990.002	107	97.8700.423	208		
95.1991.002	107	97.8700.430	208		
95.1993	107, 130, 131	97.8700.431	208		
95.1994	107, 130, 131	97.8700.432	208		
95.1995	107, 130, 131	97.8700.433	208		
95.1999	130, 131	97.8700.440	208		
95.7780.191	216	97.8700.445	208, 209		
95.7780.192	216	97.8700.450	208		
95.7780.193	216	97.8700.452	208		
97.8071.400	201	97.8700.453	208		
97.8100.000	195	97.8700.461	208		
97.8100.001	195	97.8700.466	208		
97.8100.002	195	97.8700.467	208		
97.8100.003	195	97.8700.470	208		
97.8100.004	195	97.8700.980	208		
97.8100.010	195	97.8700.985	209		

General comments

This catalog contains information on and images of products which may not be available in some countries. Where appropriate, these products must be approved by the competent authorities in the respective country and released for sale before they can be sold in that country. None of the information and images found in this catalog are to be understood as advice or advertisement for a product or the use of this product in a manner which is not approved by the laws and regulations of the respective country in which the user is based.

This catalog solely serves to provide general information. All statements on medical, health and technical subjects do not replace medical, scientific or technical advice in any way.

The information, drawings, images, technical data, dimensions and performance descriptions found in this catalog are to be understood as approximate values unless they are expressly labeled as binding. We expressly reserve the right to make technical changes to our products.

We would be happy to send you our company terms and conditions on request.



SARSTEDT

Sarstedt, Inc.

1025 St. James Church Road

P.O. Box 468 · Newton, NC 28658 - 0468

Tel: +1-828-465-4000 · Toll free: +1-800-257-5101 · Fax: +1-828-465-4003

customerservice.us@sarstedt.com · www.sarstedt.com